

Basics of Partial Discharge

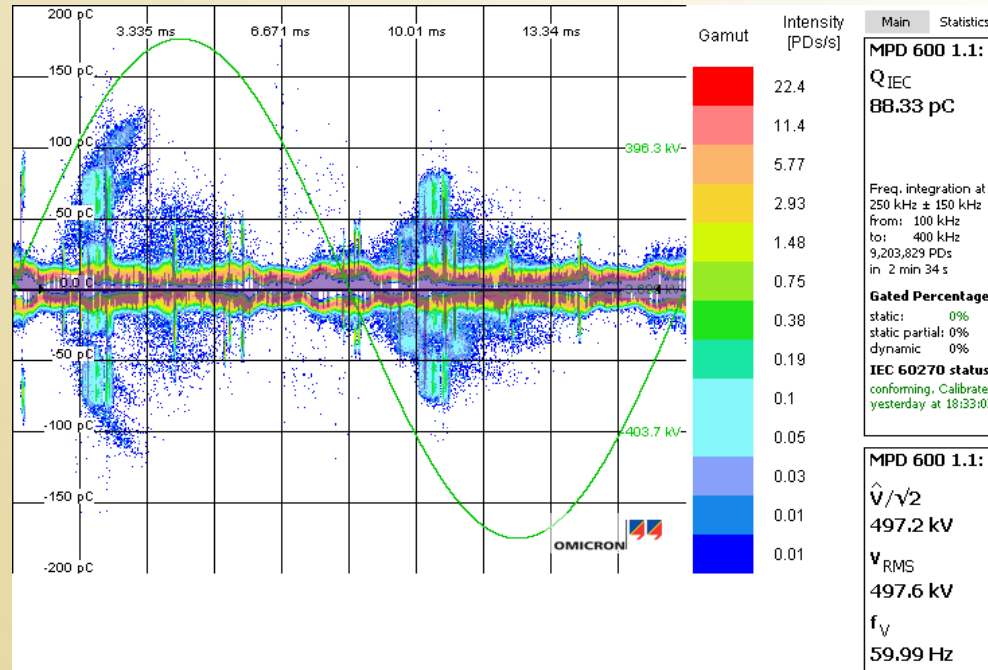

Prepared for 2015 Phenix RSM Meeting
 January 2015



Definitions and History



Standard Definitions

- Fundamentally, what is a “Partial Discharge”
 - An electric discharge which only partially bridges the insulation, and which may or may not occur adjacent to a conductor
 - Authoritative Dictionary of IEEE Standard Terms
 - A discharge that does not completely bridge the insulation between electrodes
 - IEEE Standard 4, IEEE Standard for High-Voltage Testing Techniques
 - Localized electrical discharge that only partially bridges the insulation between conductors and which can or can not occur adjacent to a conductor
 - IEC 60270 High-voltage test techniques – Partial discharge measurements



Significance to High Voltage Equipment

Why Do People Care About Partial Discharge in Insulation?

- Repeated partial discharges in insulation lead to a degradation of the insulation over time, which may eventually lead to failure of the insulation system, and potential total destruction of the equipment
- Partial discharges generally begin in gas filled voids in solid insulation, in gas bubbles in oil, or at interfaces between different insulating materials if the electric field stress is too high
- Partial discharges may be thought of as localized spark discharges occurring in voids or over insulation surfaces, which over time lead to the carbonization of the insulation due to the heat released in the spark discharge
- Carbon = Electrically Conductive = Not Insulating!



First Recognition of PD Phenomena

LICHTENBERG FIGURES (1777)

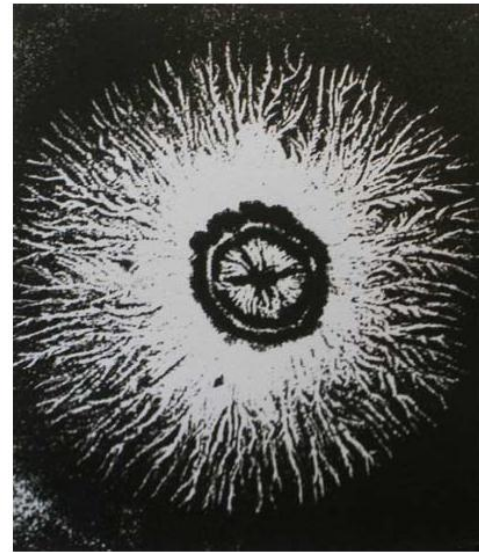

Positive Discharge

Negative Discharge

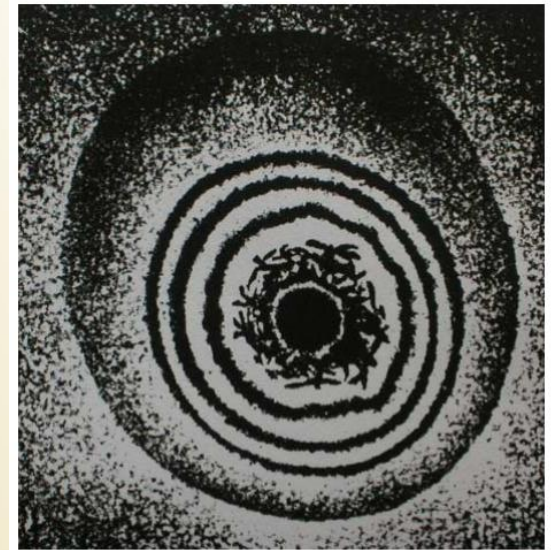

Surface Discharge Traces on Insulation

LICHTENBERG FIGURES DUE TO LIGHTNING STRIKES

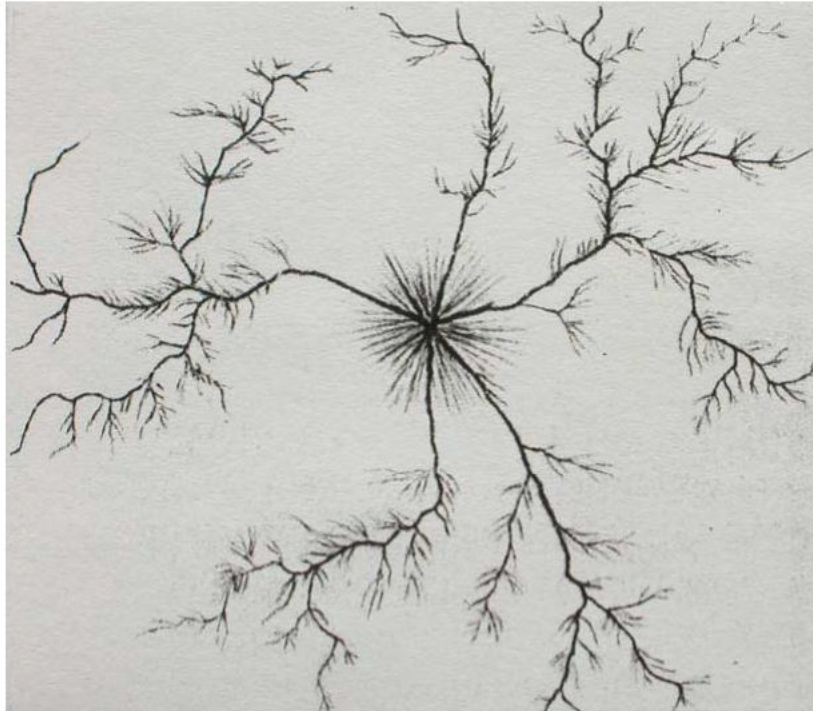

Positive Lightning

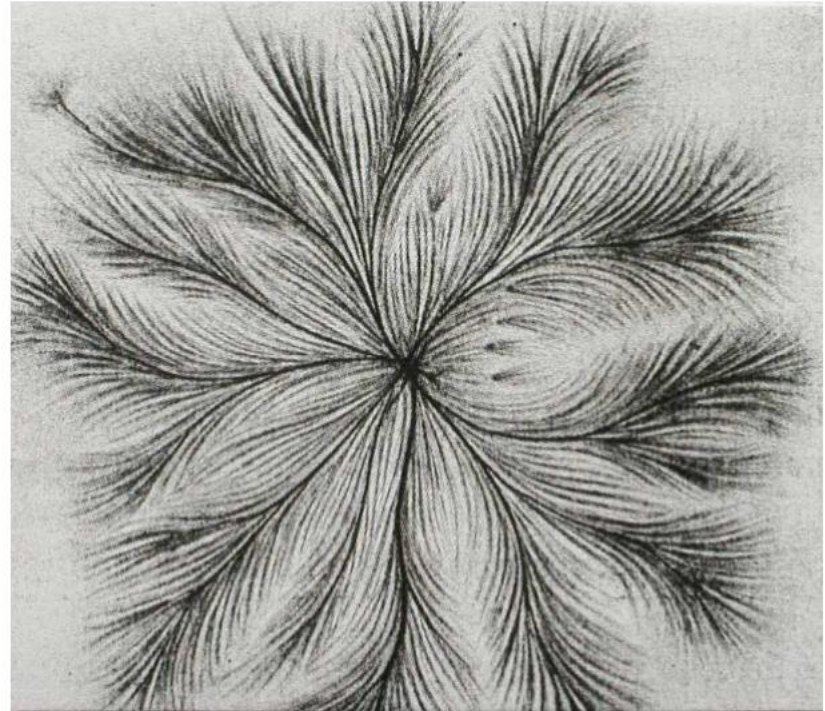

Negative Lightning

Clydonograph records made by Müller, 1927



Surface Discharge Traces on Insulation

DISCHARGE TRACES IN A POWER TRANSFORMER

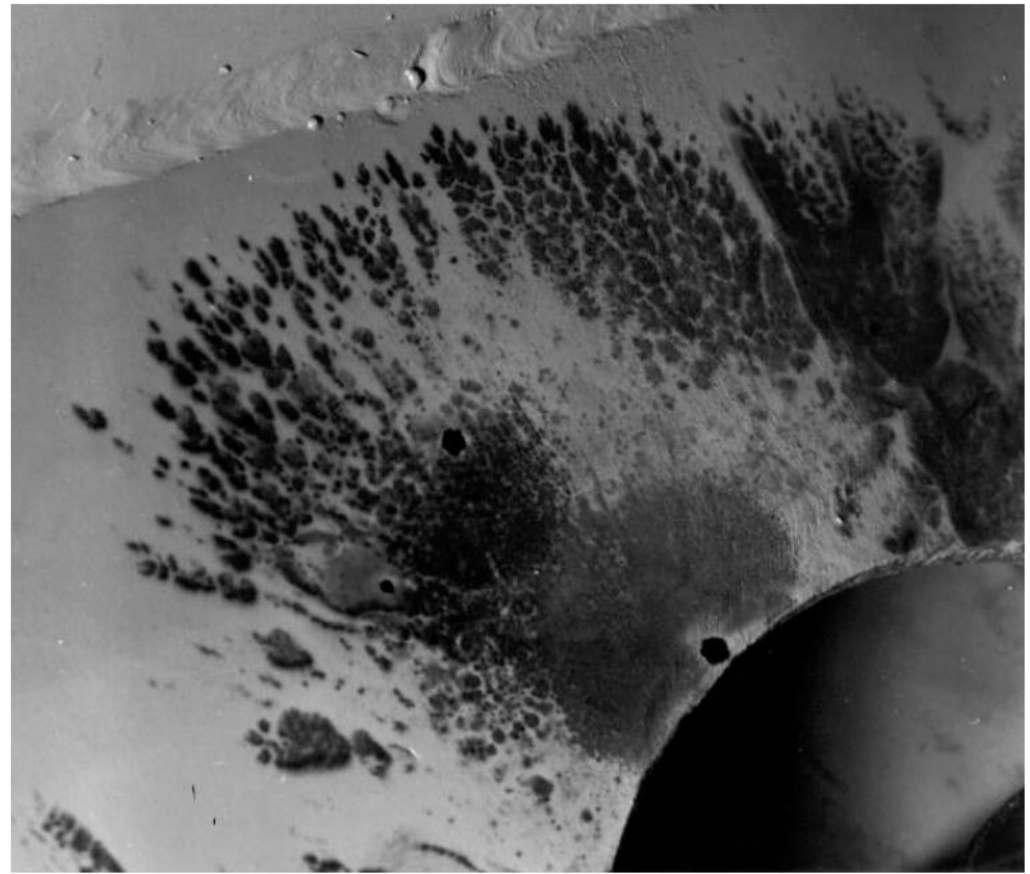

Surface Discharge Traces on Insulation

TRACKING DISCHARGES ON TRANSFORMER BOARD

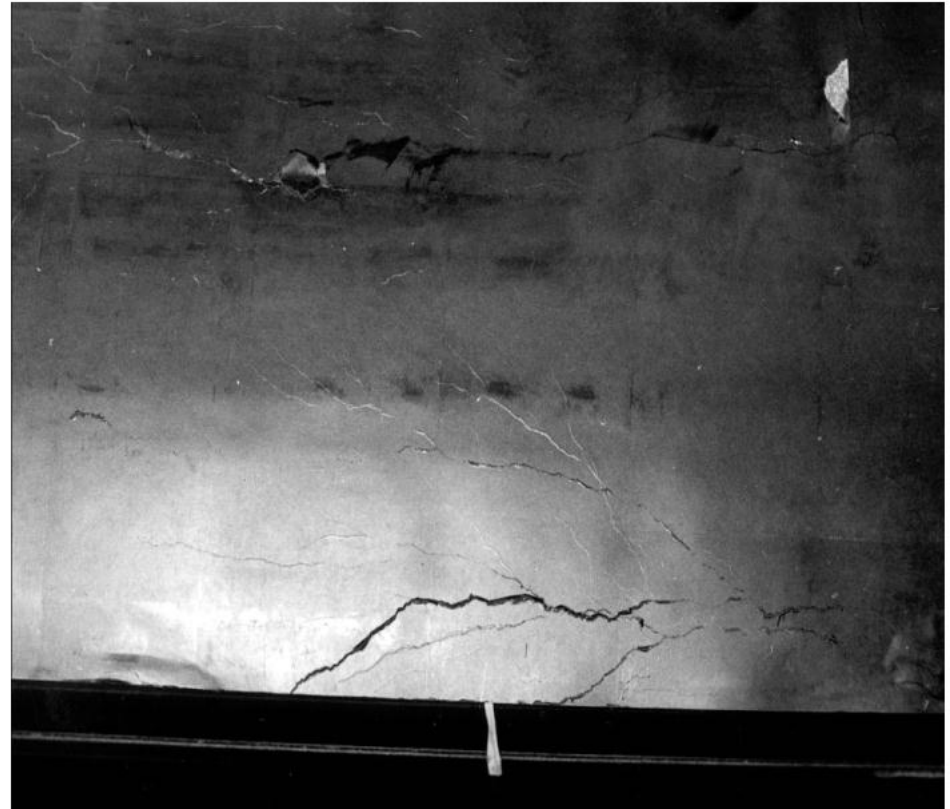

Discharge Patterns in Insulation

TYPICAL DISCHARGE FIGURES



Insulation Tracking in Air

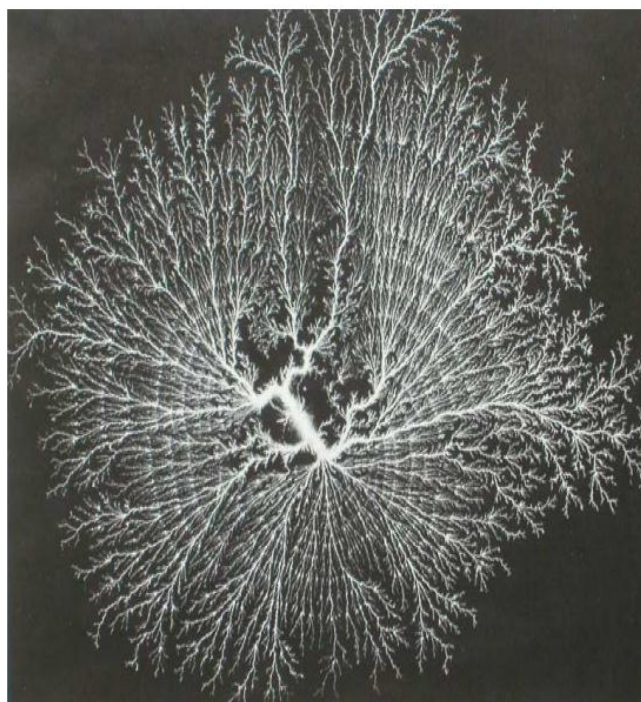

Insulation Tracking in Oil



Treeing in Solid Insulation
(Plexiglass)



Other Related Terms of Interest

- **Corona:** A form of partial discharge that occurs in gaseous media around conductors which are remote from solid or liquid insulation. The term “corona” is most often used to refer to luminous partial discharges occurring in air in regions of high electric field stress, as these discharges emit visible light.
- **Disruptive Discharge:** A discharge that completely bridges the insulation under test, reducing the voltage between the electrodes to practically zero. Syn: electrical breakdown
- **Flashover:** A disruptive discharge over the surface of a solid insulation in a gas or liquid.
- **Sparkover:** A disruptive discharge between electrodes in a gas or liquid.
- **Puncture:** A disruptive discharge through solid insulation.



Photo of Corona in Air



Corona Emission from Energized Parts of Transmission Line Suspension Insulator



Physics



The Nature of an Actual PD Pulse

- An actual PD pulse may be described as a very fast current pulse (charge displacement) that takes place intermediate to an insulating medium
- Coincident to the charge displacement, a localized collapse in voltage takes place, as the electric field is momentarily reduced to near zero in the region of the ionized material (spark)
- The actual current pulse resulting from a PD is very short lived, usually decaying to zero in less than a microsecond

Figure at Right taken from CIGRE Brochure No. 366, "Guide for Partial Discharge Measurements in Compliance to IEC 60270"

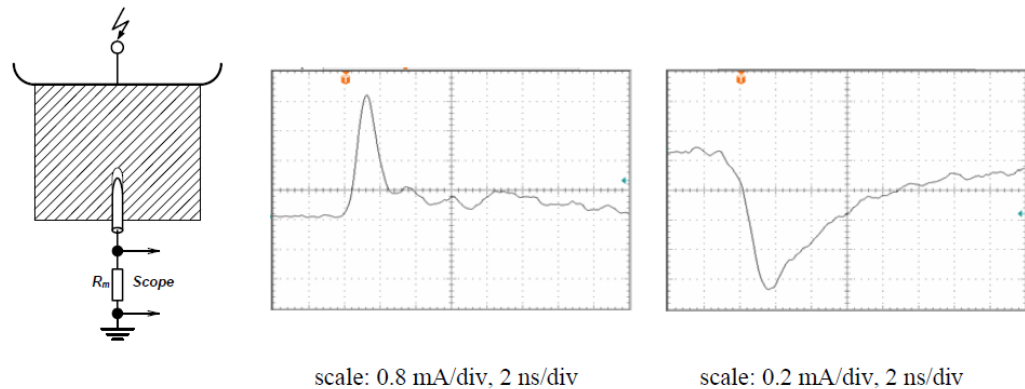
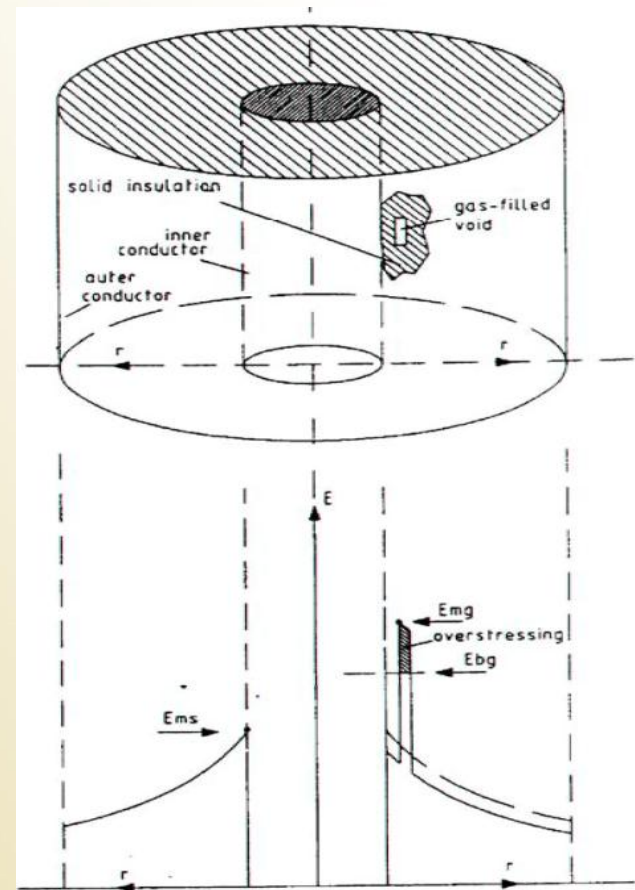

Fig. 3: Positive and negative PD current pulses of a cavity discharge in XLPE



PD Resulting from AC Excitation

- As voltage is applied, an electric field is generated between the conductors
- Because the permittivity of the gas contained in the void is lower than that of the surrounding insulation (all gasses have a relative permittivity of approx. 1.0) the electric field within a void is enhanced (strengthened) relative to that within the insulation
- If the field stress in the void exceeds the breakdown strength, an electrical discharge (spark) occurs in the void



Representation of a Void In Cable Insulation



PD Resulting from AC Excitation

(Continued...)

- After the discharge (spark) is extinguished, the charge is momentarily redistributed within the cavity, “de-stressing” the void
- The effect of this “de-stressing” is shown in the oscilloscope trace at the right
- After the discharge occurs, the voltage again builds across in the void, as the applied AC voltage continues along its normal cycle
- At the inception voltage, the critical breakdown stress within the void is not reached again before the AC voltage reaches its peak value, resulting in a single discharges per half cycle

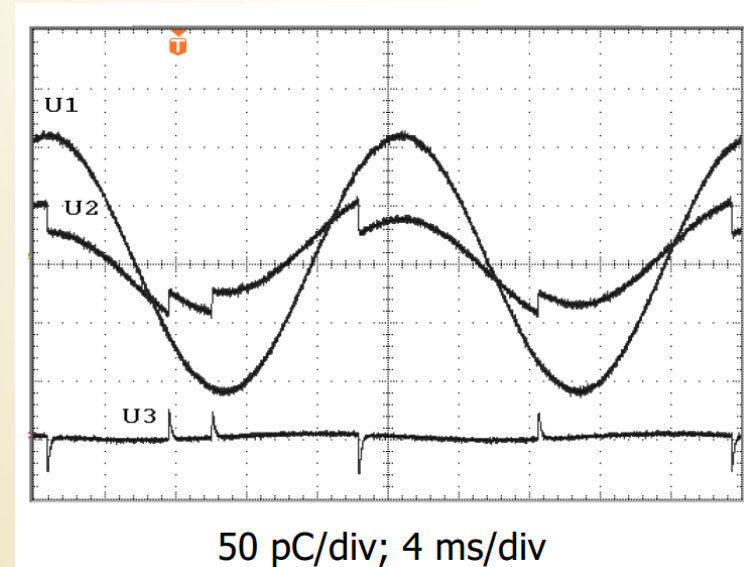

Example of a Single PD Event Occurring Within a Half Cycle of AC Voltage

U1 – Total Voltage Across Insulation
U2 – Voltage Across Void
U3 – Voltage Across Void with AC Voltage Subtracted



PD Resulting from AC Excitation

(Continued...)

- With higher applied AC Voltage applied, the critical breakdown stress may again be reached within the void before the AC voltage reaches its peak value
- This results in multiple discharges per half cycle, as shown in the oscilloscope trace at the right
- The time interval between ignition and extinction of the actual discharge pulse is < 100 ns, and results in an electromagnetic transient in the order of 100 ns

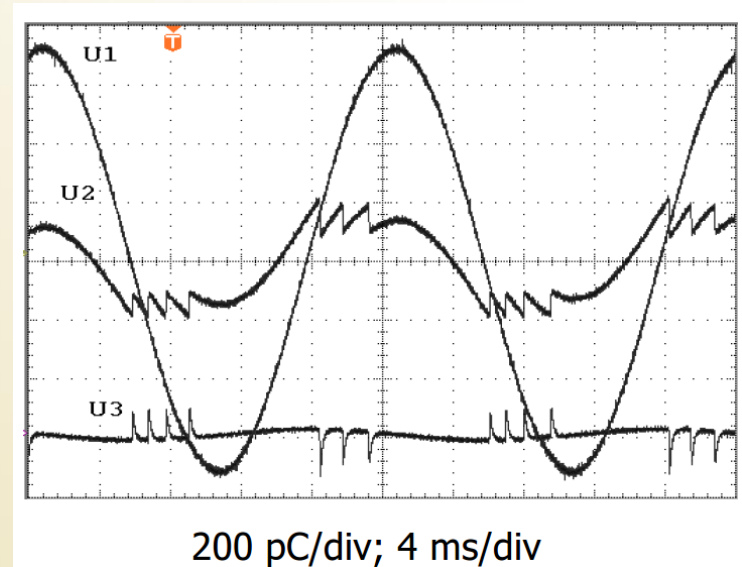

Example of a Multiple PD Events Occurring Within a Half Cycle of AC Voltage

U1 – Total Voltage Across Insulation

U2 – Voltage Across Void

U3 – Voltage Across Void with AC Voltage Subtracted



PD Resulting from DC Excitation

- Unlike the repetitive, periodic discharges occurring with AC excitation, discharges occurring under DC excitation are generally sporadic and irregular
- After a discharge occurs, and without further changes in the applied voltage, the re-stressing (re-charging) of a void takes time, depending on the magnitude of the applied voltage and the insulation resistance



PD Measurement



CABLE



GIS

SWITCHGEAR



CIRCUIT

BREAKER



TRANSFORMER



MOTOR



GENERATOR



INSULATION

MATERIALS



RECLOSER



PROTECTIVE

EQUIPMENT



PORTABLE

Practical Definition of a Partial Discharge

- For measurement purposes, a partial discharge can be thought of and modeled as:

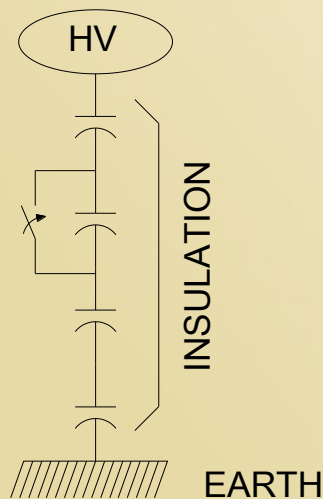

“A nearly instantaneous change in the capacitance of an insulation system”

- Per David Train, Former Chair of IEEE Power Systems Instrumentation and Measurement Committee, and Former High Voltage Lab Manager at IREQ



PD Measurement Concepts

What quantities could we measure to quantify the magnitude of a PD pulse?

- Current
- Voltage
- Displaced Charge (the integral of current over some time)
 - Actual Charge
 - Apparent Charge



PD Measurement Concepts

(Continued...)

Measuring simple voltage and current magnitudes or pulse shapes is problematic for a number of reasons

- Discrete voltage and current events are extremely fast and therefore difficult to capture
- Voltage and current values associated with individual discharge events are tiny in relation to the power frequency voltage and currents normally present in HV equipment, thus measurement sensitivity and noise becomes a serious problem
- The complex, distributed RLC nature of many test objects introduces filtering effects that significantly alter the magnitude and wave shape of the resulting transient voltages and current pulses appearing at the terminals of the test object
- Making repeatable measurements with different measuring equipment, under differing conditions, becomes almost impossible



Measurement Concepts

(Continued...)

The standard measurement technique in use since the 1970's is known as the “Apparent Charge Method”

- The measuring circuit and the associated calibration requirements are specified in IEC 60270 - 2000, “High-voltage test techniques – Partial discharge measurements
- Apparent charge q of a PD pulse is that charge which, if injected within a very short time between the terminals of the test object in a specified test circuit, would give the same reading on the measuring instrument as the PD current pulse itself. The apparent charge is usually expressed in picocoulombs (pC)

Note: The apparent charge is not equal to the amount of charge locally involved at the site of the discharge, which cannot be measured directly

- IEC 60270 (2000) Clause 3.3.1



Measurement Concepts

(Continued...)

Apparent Charge

Simple model of a partial discharge in an insulating medium

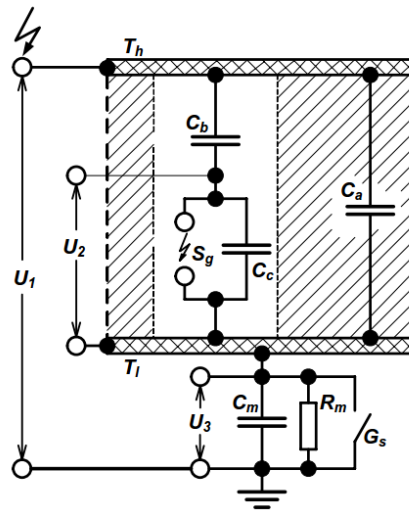

C_a – virtual test object capacitance
 C_b – stray capacitance of the PD source
 C_c – internal capacitance of the PD source
 C_m – measuring capacitor
 R_m – measuring resistor
 G_s – grounding switch

S_g – spark gap
 T_h – high voltage terminal of the test object
 T_l – low voltage terminal of the test object
 U_1 – test voltage applied
 U_2 – voltage drop across the PD source
 U_3 – voltage drop across R_m



Measurement Concepts

(Continued...)

Apparent Charge

- With G closed voltage drop across defect appears across test object
- With G open voltage pulses across the measuring impedance can be measured

$$\tau_m = R_m * C_m$$

if $\tau_m >$ duration of pulse charge transfer, effect on R_m can be neglected and U_3 is proportional to U_1 , C_a and C_m form voltage divider with

$$U_3 = U_1 * C_a / (C_a + C_m)$$

With $C_m \gg C_a$

$$U_3 * C_m = U_1 * C_a = q_a$$



Measurement Concepts

(Continued...)

Apparent Charge

With $C_a \gg C_b$

$$U_2 * C_b = U_1 * C_a = q_a$$

Multiplying with $C_a/C_a=1$

$$q_a = U_2 * C_a * C_b/C_a = q_{c1} * C_b/C_a$$

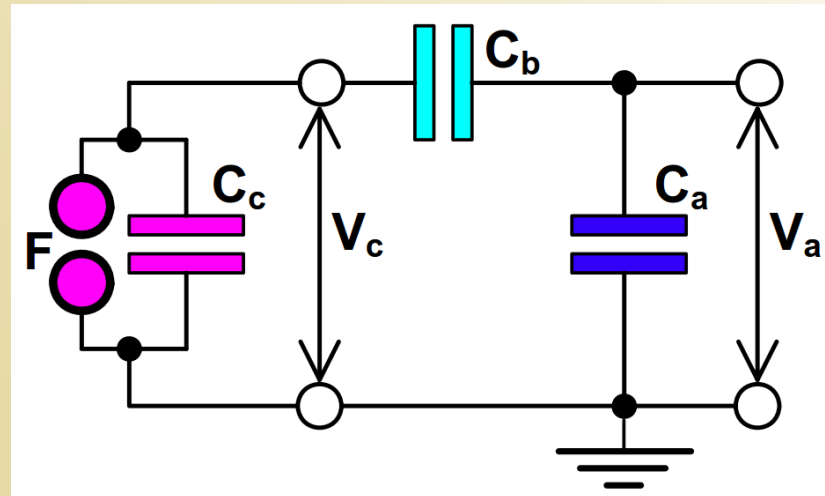

Measurement Concepts

(Continued...)

Apparent Charge

Example:

$$U_1 = 1 \text{ kV}, C_1 = 1 \text{ pF}$$

$$C_2 = 0.01 \text{ pF} = 0.01 * C_1$$

$$C_3 = 100 \text{ pF} = 10000 * C_2$$

A voltage drop of 1 kV at C_1 results in a voltage drop of 0.1 V at C_3

$$q_c = U_1 * C_1 = 1 \text{ kV} * 1 \text{ pF} = 1000 \text{ pC}$$

$$q_a = U_3 * C_3 = U_1 * C_2 = 1 \text{ kV} * 0.01 \text{ pF} = 10 \text{ pC}$$

$$\frac{q_a}{q_c} = \frac{C_2}{C_1} = 0.01$$



Measurement Concepts

(Continued...)

Apparent Charge

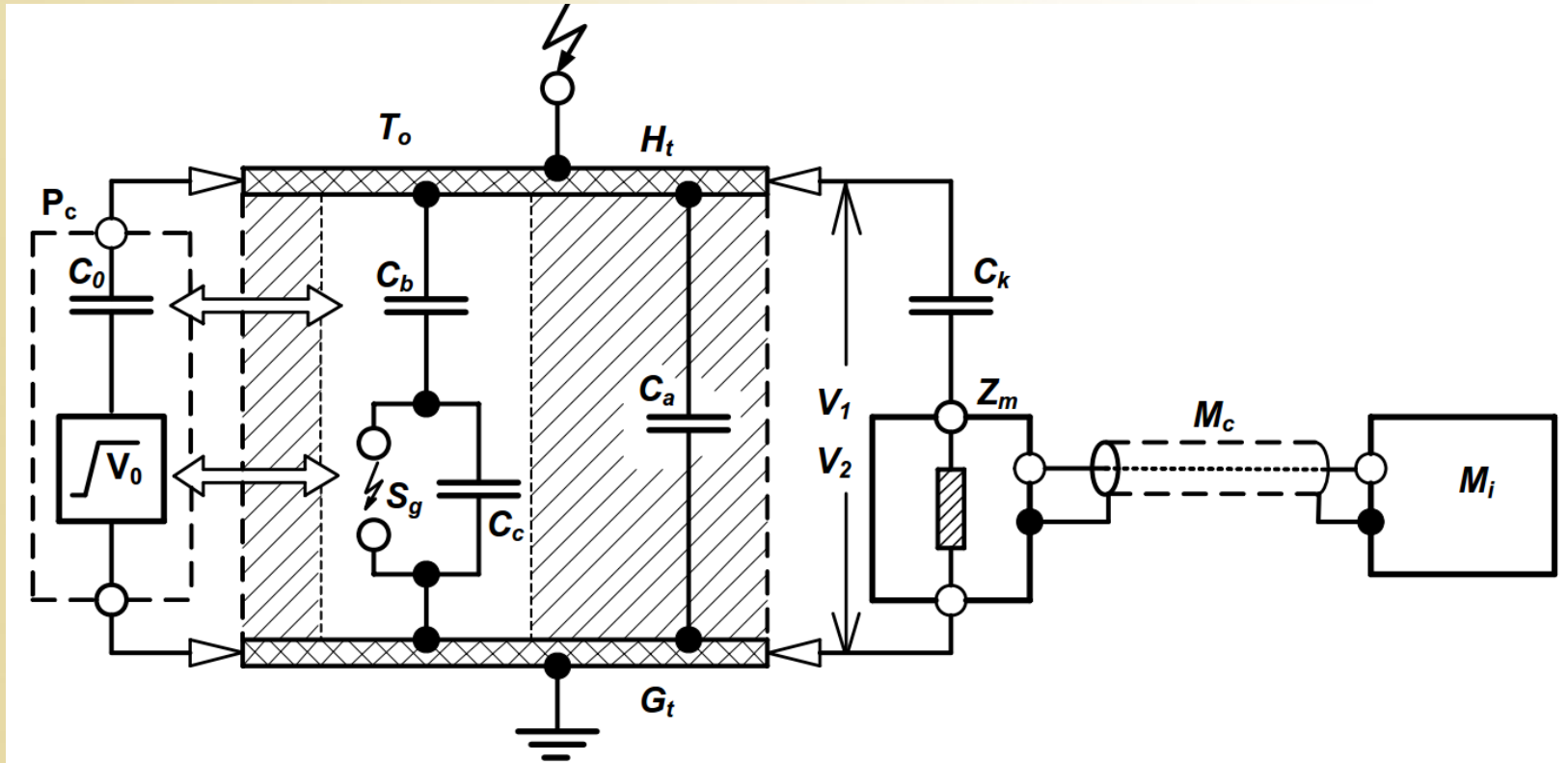

Equivalence of Charge Transfer Due to a PD Pulse
and a Calibrating Pulse



Diagnostics



Diagnosing Defects by PD Pattern

Different types of insulation defects result in PD patterns having some different, identifiable characteristics

Examples

- Corona in air or oil
- Discharges occurring in a void (or voids) surrounded by insulation
- Discharges occurring in a void bounded by a conductor
- Tracking discharges over an insulating surface in air or oil
- Discharges in gas bubbles within an insulating liquid
- Discharges resulting from poor connections / contact noise in the HV circuit
- Floating object PD



Diagnosing Defects by PD Pattern

(Continued...)

Items to consider during PD pattern recognition

- Location of PD pulses over the AC voltage waveform
 - Before or after AC voltage peaks
 - Near voltage zeros
- Movement of pulses over the AC voltage waveform
 - Random movement
 - Repeated movement
 - Stationary
- Comparison of pulse amplitude on positive and negative half cycles
- Relationship between inception and extinction voltage
- Effect of voltage on pulse amplitudes
- Effects of time on pulse amplitude and location



Diagnosing Defects by PD Pattern

(Continued...)

Many books and papers have been published over the years on the subject of PD patten recognition in high voltage equipment

One of the most generic and useful of these remains a CIGRE Electra Paper titled “Recognition of Discharges” published in 1969

Figure at Right taken from “Recognition of Discharges”, as published in CIGRE Electra Issue No. 11, 1969



Prepared by CIGRE Working Group 21.03
Convornor: Mr. F. H. Kreuger

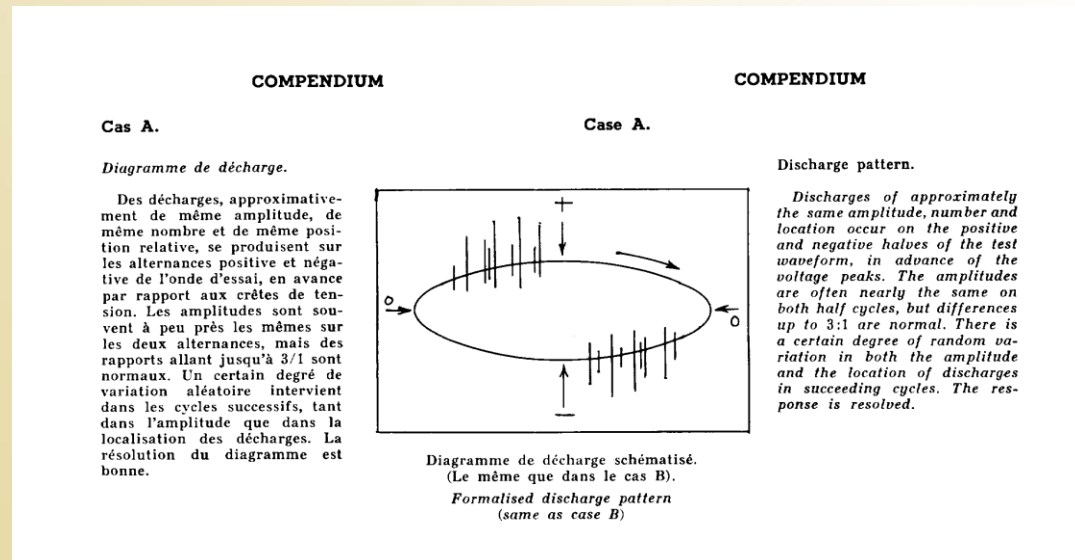

Questions?

