

# PLS OPERATING MANUAL

## PLS HVR 505



**PACIFIC LASER  
SYSTEMS**

The Professional Standard

# TABLE OF CONTENTS

Introduction.....	1
Safety Information.....	2
Batteries.....	3
Keypad.....	4
Operation.....	5
Functions.....	6
Applications.....	7
Remote Control.....	8
Checking Calibration.....	9
Specifications.....	10
Warranty.....	11
PLS HVD Detector.....	12
PLS HVD Operating Manual .....	13



Call Us 1.877.571.7901

# INTRODUCTION

The PLS HVR 505 is a fully automatic, self-leveling laser used for height transfer and layout. The HVR 505 R is a traditional, visible red beam rotary laser used for both interior and exterior layout. The HVR 505 G is a highly visible, green beam rotary laser ideally used for interior layout. The HVR 505 G may also be used for exterior applications. The rechargeable PLS HVR 505 contains micro-controlled charging technology.

**CAUTION: DO NOT ATTEMPT TO CHARGE STANDARD ALKALINE BATTERIES OR WARRANTY WILL BE VOIDED.**

The PLS HVR 505 may be used in vertical and horizontal mode and has an up and down plumb beam. It also has an additional line marker (scanning) function and may be controlled by the PLS RC 505 remote control.

The instrument is water resistant and may be used in the rain, if necessary. Unit may not be submerged in water.



# SAFETY INSTRUCTIONS

## Laser Safety

The PLS HVR 505 R is a class II laser according to 21CFR1040. The PLS HVR 505 G is a Class IIIA laser. Follow the instructions on the warning labels which are shown in the following illustrations:



PLS HVR 505 R

Laser Power:

635 nm

<1mW

Laser Class II

PLS HVR 505 G

Laser Power:

532 nm

<5mW

Laser Class III

Do not remove the attached warning labels. The manufacturer and its dealers are not liable for any defects and the consequences from this removal.

**! Attention !** The internal laser sources comply with with laser classes II and IIIA. Do not disassemble the instrument. In case of inappropriate repairs, laser radiation may arise in excess amounts of the marked labels and liability may be incurred if there is damage. In cases of inappropriate processing, malfunctions are possible without external visible damage.

The unit charger should only be used indoors. **DO NOT ATTEMPT TO CHARGE STANDARD ALKALINE BATTERIES.**

**Attention:** This instrument contains nickel metal hydride batteries. NiMH batteries must be recycled or disposed of properly. WEEE-Reg.: DE23874031



## BATTERIES

The PLS HVR 505 uses rechargeable NIMH batteries.

For on-board chargeable battery, insert the battery re-charger receptacle plug in the charging panel outlet of the battery cover back.

Insert converter's AC receptacle plug in an AC outlet and insert the converter's DC receptacle plug in the charging panel's DC outlet.

When the charging lamp is on, charging is in process.

ALKALINE  
BATTERY PACK →



NIHM RECHARGEABLE  
BATTERY PACK →

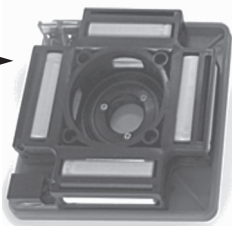

When the charging lamp is green, charging is completed.

**NOTE:** The charging process takes approximately 7 hours to complete for rechargeable batteries.

AC/DC converter's suitable power range: 50-60Hz; voltage 85V-265V.

Purchase replacement NIMH battery pack from an authorized PLS dealer.

Use PLS HVR 505 with caution in humid or wet weather conditions. Do not put the laser back into the case unless it is thoroughly dry. Condensation may corrode the battery connections and/or cause distortion of beams in lighthouse.

# KEYPAD

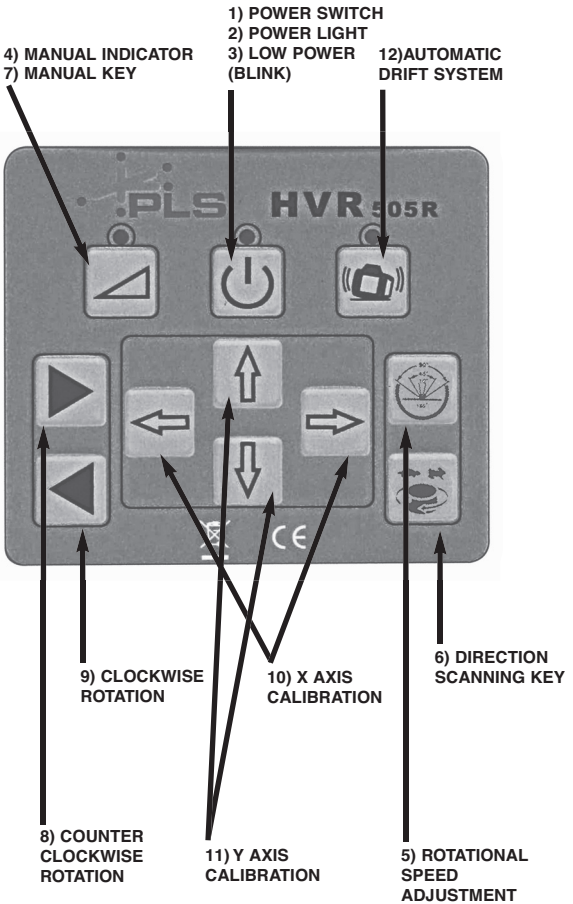

## KEYPAD OPERATION – FUNCTIONS AND INDICATORS

- 1) Power switch: turn on or off unit.
- 2) Power light: red light, power on.
- 3) Low Battery Indicator: LED blinks, the battery should be charged or replaced.
- 4) Manual Indicator: green LED on in manual mode.
- 5) Accelerate key: variable speed, 0-60-120-600 r.p.m., press multiple times to adjust through a cycle.
- 6) Scanning key: variable angle, 0-10°-45°-90°-180°, press multiple times to adjust through a cycle.
- 7) Manual/automatic key: to change from automatic to manual leveling.
- 8) Counterclockwise rotation key: when rotation is stopped, press to start scanning of orientation.
- 9) Clockwise rotation key: when rotation is stopped, press to start scanning of orientation.
- 10) Adjustment key in X slope direction: when the instrument is in the manual mode, press to adjust slope of X direction.
- 11) Adjustment key in Y slope direction: when the instrument is in the manual mode, press to adjust slope of Y direction.
- 12) Tilt or ADS (automatic drift system) blinks slowly when active, blinks quickly to warn user of a change in alignment from original set up.

# FUNCTIONS



## Power switch

Press 1  (See keypad chart) The unit is self-leveling and power light is lit. Press the key again and the unit will turn off.

After laser has automatically leveled, the laser beam stops blinking. The laser will rotate up to 600 r.p.m. If the gradient exceeds  $\pm 5^\circ$ , the manual indicator will blink.

**NOTE:** If the unit does not level within 5 minutes, it will shut off.



## Rotation Mode



The 5  key adjusts rotation speed. Adjust through a cycle. To stop rotation, press the 5  key. Rotation will be counter clockwise.

When the 9  key is pressed, rotation will be clockwise.

## Scanning Mode



Adjust rotation speed until the laser stops rotating.

Press the 6  key and the unit starts scanning mode. Press the 6  key again to adjust scanning angle.

Press 8  counter clockwise or 9  clockwise; key will move scanning laser line.



## Setting Slope

The PLS HVR 505 can set slope on dual axes. Press the 7.  The manual indicator is on.

**Setting slope of X direction:** Aim X1 of the instrument in the direction necessary to set slope. Press 10.  

The laser beam moves upwards or downwards.

## Setting slope of Y direction.

Aim Y1 of the instrument in the direction necessary to set slope.  

Press 11.

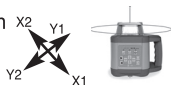

The laser beam moves upwards or downwards.

## Automatic Drift System

Press 12. Press the TILT key, the power indicator blinks slowly. After the instrument has leveled automatically for about 3 seconds, the ADS function is activated. The power indicator will blink quickly, and automatic leveling function shuts off when the instrument is disturbed by external circumstances. At the same time, the laser module will stop scanning and start blinking.



# APPLICATIONS

## Height Transfer (Leveling)

Turn the instrument on. The leveling LED is flashing and the instrument is self leveling. If the LED lights

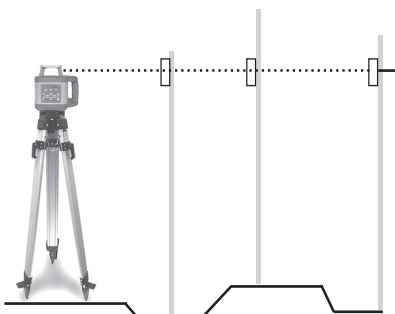

continuously the rotary head starts and the laser beam will be turned on. Attach the PLS HVD 505 Detector at this reference point on a rod and move this height to zero. Now the respective difference in levels to the reference height can be measured on the ground. It is useful to use a flexible rod to measure positive and negative values simply.

## Laying out Slope Using the PLS HVR 505

Fasten the PLS HVR 505 to a tripod and plumb up over the benchmark or hub. Make certain that the PLS HVR 505 is positioned on the tripod so that the X axis points toward where you need slope. Auto-level the PLS HVR 505 by depressing the top green button. Once the laser is level and rotating at 600 rpm, attach the detector to the grade rod. Take the grade rod with the detector attached to the end of the needed distance (end of pipe, footing or form board). Find level on the detector by a solid tone or by the solid line on the LCD. Next, depress the top center button on the remote (RC 505) to engage the manual mode on the PLS HVR 505. Then lower the detector by the correct distance based on the needed slope. Some examples are listed below. Depressing the right red button lowers the laser towards the detector. Hold down the right-pointing arrow key until the detector beeps that you are within range. Now fine-tune the laser adjustment by going up using the left-arrow key or down using the right-arrow key until the laser is locked on with a solid tone or by the solid line on the LCD.



## Examples

-1% Slope @100'  
Lower the detector on the grade rod 12" from level

-3% Slope @100'  
Lower the detector on the grade rod 36" from level

-1% Slope @50'  
Lower the detector on the grade rod 6" from level

-3% Slope @50'  
Lower the detector on the grade rod 18" from level

-1% Slope @25'  
Lower the detector on the grade rod 3" from level

-3% Slope @25'  
Lower the detector on the grade rod 9" from level



For a positive slope layout, reverse the above examples.

# APPLICATIONS

Caution ! The automatic leveling is switched off in manual mode. If the instrument gets moved it will not turn off. In the semi-manual mode the tilt control is active only in X direction. We recommend using a second detector to control the sloped plane.



## Vertical Use



The PLS HVR 505 has third leveling axis (z-axis). Place the instrument as shown. The plumb beam will be leveled automatically. The turning rotor head projects an upright plane to the plumb beam at an angle of  $90^\circ$ . To adjust the alignment line use the arrow keys to move the laser beam right and left.

Right angles can then be measured simply and quickly.

CARE: Key pad face up for vertical.

# REMOTE CONTROL

The PLS HVR 505 may be used with the PLS RC 505 infrared remote control. Point the remote in the direction of the PLS HVR 505 for remote operation. Remote distance is 70 feet indoors and 40 feet outdoors. There are 9 keys on the panel of the remote unit. The remote panel matches the keypad of the PLS HVR 505. Pressing any key will make the indicator lamp blink once indicating remote signal is being sent.

# CHECKING CALIBRATION

The PLS HVR 505 should be checked, like all measuring instruments, before use. Set the PLS HVR 505 on a stable surface - Method A. Turn the laser on and let it level. Mount the PLS HVD 505 Detector at a fixed distance, e.g. at 90 feet, and move it onto the laser plane. Now turn the instrument around to each  $90^\circ$  point and let the instrument level. In each case, measure the difference to the first height. If the deviation is smaller than  $1/8$  inch, the instrument is within the specification. In the case of larger deviations the instrument has to be calibrated.

# CHECKING CALIBRATION

## A. Instrument Checking - Method B

(1) Place the instrument at the point of 90 feet in front of wall (or set a scaleplate at the point of 90 feet away from the instrument), and then adjust the level of the base approximately to aim the X1 to the wall (or scaleplate) as depicted at right.

(2) After switching on the power, use the detector measuring the  $h_1$  of X1-beam on the wall or scaleplate. (3) Loosen the screw of the tripod and then turn the instrument  $180^\circ$  to measure the  $h_2$  of X2-beam on the wall or scaleplate.

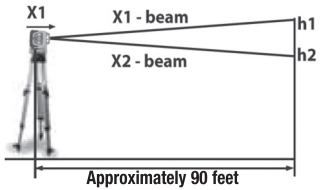

**D-value between  $h_1$  and  $h_2$  ought to be less than 1/8 inch.**

(4) Check the Y-beam in the same way.

## B. Level Adjusting

If the D-value between  $h_1$  and  $h_2$  is more than 1/8 inch, adjust the instruments according to the following steps:

1. Y-axis adjustment. (1) Press the Key ON/OFF when power indicator lights & automatic leveling of the instrument starts up. (2) Press the key “←” and “→” simultaneously for 3 seconds; when mode indicator blinks, the instrument enters mode of adjusting. (3) Press the key “↑” or “↓” of Y-axis repeatedly and check the position of laser beam when mode indicator is blinking until the D-value between  $h_1$  and  $h_2$  is less than 1/8 inch. (4) Press the Key “←” and “→” simultaneously to hold the adjustment until mode indicator goes out. If the instrument is set horizontally, Y-axis adjustment stands for Z-axis adjustment.

## C. X-axis Adjustment

(1) Press the Key ON/OFF when power indicator lights & automatic leveling of instrument starts up. (2) Press the Key “↑” and “↓” simultaneously for 3 seconds. When undervoltage indicator blinks, the instrument enters mode of adjusting. (3) Press the Key “←” or “→” of X-axis repeatedly and check the position of laser beam while undervoltage indicator is blinking till D-value between  $h_1$  and  $h_2$  is less than 1/8 inch. (4) Press the Key “↑” and “↓” simultaneously to hold the adjustment until undervoltage indicator goes out. If canceling the adjustment, please shut off the instrument and then turn it on. If the adjusting range exceeds range permitted, the power indicator will flash.

**Notice: Once the D-value exceeds the error range that instrument permits, please contract the supplier to repair the instrument.**

## D. Plumb Point Check

(1) Place the instrument between two walls with distance of 90 feet.

(2) Place the instrument on its side and then adjust. (3) Switch on the power, and then measure the middle point of the laser beam on the wall:  $h_A$ ,  $h_B$  and  $h_A'$ ,  $h_B'$ .

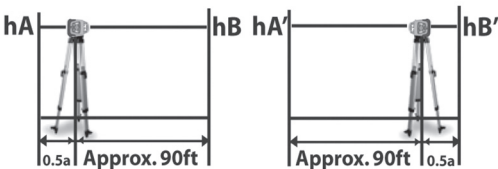

(4)  $\Delta_1 = h_A - h_A'$ ,  $\Delta_2 = h_B - h_B'$ . **D-value between  $\Delta_1$  and  $\Delta_2$  ought to be less than 1/8 inch.**

**E. Adjusting** If-D value between  $\Delta_1$  and  $\Delta_2$  is more than 1/8 inch, adjust the instrument according to procedure described in B.

# ROTARY SPECIFICATIONS

## PLS HVR 505:

Accuracy:	+/- 1/8 inch @100 feet 3 mm @ 30 meters
Down point accuracy:	+/- 1/8 inch @10 feet 3 mm @ 3 meters
Up point accuracy:	+/- 1/8 inch @100 feet 3 mm @ 30 meters
Leveling range:	± 5°
Operation range:	Radius 500 feet w/detector 150 m
Rotation speed:	0 - 600 rpm
Light source:	laser diode, wavelength 635 nm, <1 mW (HVR 505 R) wavelength 532 nm, <5 mW (HVR 505 G)
Operating temperature:	32 °F (0 °C) to 140 °F (40 °C)
Storage temperature:	-22 °F (-30 °C) to 140 °F (60 °C)
Laser Class:	II Caution (21CFR1040) (HVR 505 R) III DANGER (HVR 505 G)
Power supply:	4 x C Size NIMH Batteries
Operating time:	approximately 20 hours
Charging time:	maximum 7 hours <b>(NiMH ONLY)</b>
Protection grade:	IP64 (Water- resistant), not submersable
Size / Weight:	7.5 inch x 8 inch x 6 inch 190.5 mm x 200 mm x 152 mm 4.9 lbs (unit only) 2.22 kg

## PLS RC 505 Remote Control:

Operating distance 70 feet

## Charger LDG 2+2:

Model: KD500-CV

Input: AC 100 VAC-240 VAC

Output: DC 5.6 V 700 mA

**Use the charger indoors only! Do not attempt to charge Alkaline Batteries.**

**Design and specifications are subject to change without prior notice.**

## WARRANTY

In the event of a claim please contact your PLS dealer or PLS. Attempts at repair or detectable improper treatment will void any warranty claim. Please use the original transport case for shipment.

This product is warranted by PLS•Pacific Laser Systems to the original purchaser to be free from defects in material and workmanship under normal use for a period of three years from the date of purchase. During the warranty period and upon proof of purchase, the product will be repaired or replaced (with the same or similar model at our option) without charge for either parts or labor through PLS. The purchaser shall bear all shipping, packing and insurance costs. Upon completion of the repair or replacement, the unit will be returned to the customer, freight prepaid. The warranty will not apply to this product if it has been abused or altered. Without limiting the foregoing, battery leakage, dents or gouges to the plastic housing, broken optic windows, damage to the switch/LED membrane are presumed to result from misuse or abuse. Tampering with or removal of the caution or certifications labels voids this warranty.

Neither this warranty nor any other warranty, express or implied, including implied warranties of merchantability, shall extend beyond the warranty period. No responsibility is assumed for any incidental or consequential damages. This warranty gives you specific legal rights, and you may have other rights which vary from state to state.

# PLS HVD 505 DETECTOR

## 1. SPECIFICATIONS

Available Distance: From rotary PLS HVR 505 (2.0 in)

Accuracy: Precise detecting:  $\pm 1$  mm ( $\pm 0.04$  in)

Rough detecting:  $\pm 2$  mm ( $\pm 0.08$  in)

Detecting Indication: Bi-surface LCD, buzzer

Power: DC9V alkaline battery

Automatic Power-off Time: Approx. 20 minutes

Working Temperature:  $-4$  °F to  $+122$  °F ( $-20$  °C to  $+50$  °C)

Dimensions: 135 (L) X 65 (W) X 24.5 (H) mm

5-3/4" x 2-3/4" x 1"

Weight: 0.15 kg (0.44 lbs) (with battery)

## 2. LCD

Precise Detecting

Reference Position

Display: 

Rough Detecting

Reference Position

Display: 

Higher than  
reference  
(slow  
frequency  
beep)

In reference  
line (long  
beep)

Lower than  
reference  
(fast  
frequency  
beep)

Poor Power:

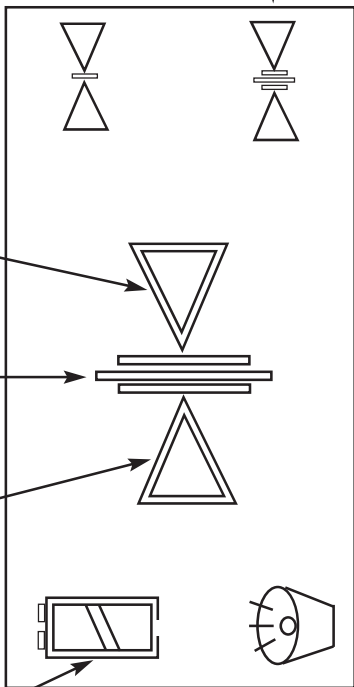
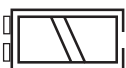

Buzzer On: 

Buzzer Off: 

# OPERATING MANUAL

## 3. PANEL

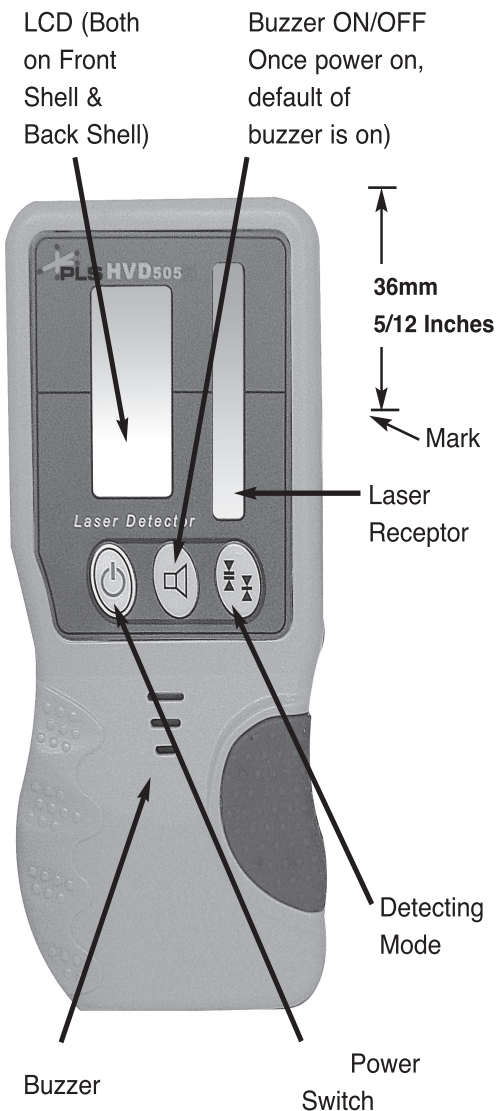

### CAUTION:

The HVD 505 R + G detectors are dedicated and unique to each HVR 505 R + G rotary laser and may not be used with other laser tools.



The Professional Standard



Call Us 1.877.571.7901

**PACIFIC LASER SYSTEMS**  
**P. O. Box 9090**  
**EVERETT, WA 98206-9090 U.S.A.**

**WWW.PLSLASER.COM**  
**+1 425 446 5500**