

*English*

# Operating manual

Cryo-Compact Circulators  
The *Economy*-Series

CF30

CF40

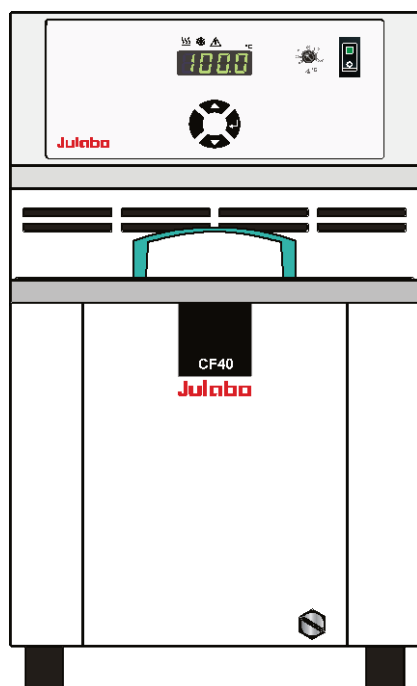

**Julabo**  
THE TEMPERATURE CONTROL COMPANY

JULABO GmbH  
77960 Seelbach / Germany  
Tel. +49 (0) 7823 / 51-0  
Fax +49 (0) 7823 / 24 91  
[info.de@julabo.com](mailto:info.de@julabo.com)  
[www.julabo.com](http://www.julabo.com)

1.951.4866-V3 11/15

---

## Congratulations!

You have made an excellent choice.

JULABO thanks you for the trust you have placed in us.

This operating manual has been designed to help you gain an understanding of the operation and possible applications of our Cryo-Compact Circulators. For optimal utilization of all functions, we recommend that you thoroughly study this manual prior to beginning operation.

## The JULABO Quality Management System



Temperature control devices for research and industry are developed, produced, and distributed according to the requirements of ISO 9001 and ISO 14001. Certificate Registration No. 01 100044846

## Unpacking and inspecting

Unpack the Cryo-Compact Circulator and accessories and inspect them for possible transport damage. Damage should be reported to the responsible carrier, railway, or postal authority, and a damage report should be requested. These instructions must be followed fully for us to guarantee our full support of your claim for protecting against loss from concealed damage. The form required for filing such a claim will be provided by the carrier.

Printed in Germany

Changes without prior notification reserved

**Important:** keep original operating manual for future use

## TABLE OF CONTENTS

Operating manual .....	4
1. Intended use.....	4
1.1. Description .....	4
2. Operator responsibility – Safety instructions .....	4
2.1. Disposal .....	6
2.2. EC Conformity .....	7
2.3. Warranty conditions.....	9
2.4. Technical specifications .....	10
3. Safety notes for the user .....	13
3.1. Explanation of safety notes .....	13
3.2. Explanation of other notes.....	13
3.3. Safety instructions .....	13
Operating instructions.....	16
4. Operating controls and functional elements .....	16
5. Preparations .....	18
5.1. Installation .....	18
5.2. Temperature application to external, closed systems.....	19
5.3. Tubing .....	20
5.4. Bath fluids .....	21
6. Operating procedures.....	22
6.1. Power connection.....	22
6.2. Filling.....	22
6.3. Switching on / Start - Stop.....	24
6.4. ⓘ Control of the cooling machine .....	24
6.5. Setting the temperatures .....	25
6.6. AUTOSTART ON / OFF .....	25
6.7. Remote control: activate – deactivate .....	26
7. Safety installations.....	27
7.1. Excess temperature protection.....	27
7.2. Low level protection.....	27
8. Troubleshooting guide / Error messages.....	28
9. Electrical connections.....	30
10. Remote control .....	31
10.1. Setup for remote control.....	31
10.2. Communication with a PC or a superordinated data system.....	31
10.3. List of commands .....	32
10.4. Status messages.....	33
10.5. Error messages.....	33
11. JULABO Service – Online remote diagnosis .....	35
12. Draining.....	36
13. Cleaning / repairing the unit.....	36

## Operating manual

### 1. Intended use

JULABO Cryo-Compact Circulators have been designed for temperature application to specific fluids in a bath tank. The units feature pump connections for temperature control of external systems (loop circuit).

	JULABO circulators are not suitable for direct temperature control of foods, semi-luxury foods and tobacco, or pharmaceutical and medical products. Direct temperature control means unprotected contact of the object with the bath medium (bath fluid).
---	---

#### 1.1. Description



- ✓ The Cryo-Compact Circulators are operated via the splash-proof keypad. The implemented microprocessor technology allows to set and to store the setpoint that can be indicated on the LED temperature display.



- ✓ The PID temperature control adapts the heat supplied to the thermal requirements of the bath.



- ✓ Safety installations conforming to IEC 61010-2-010  
The excess temperature protection is a safety installation independent from the control circuit.  
The safety value is set using a tool (screwdriver).  
If the low level protection device is triggered, a complete shutdown of the heater and circulating pump is effected.

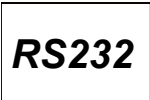
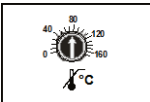

- ✓ The serial interface RS232 allows modern process technology without additional interface.

## 2. Operator responsibility – Safety instructions

The products of JULABO ensure safe operation when installed, operated, and maintained according to common safety regulations. This section explains the potential dangers that may arise when operating the circulator and also specifies the most important safety precautions to preclude these dangers as far as possible.

The operator is responsible for the qualification of the personnel operating the units.

- The personnel operating the units should be regularly instructed about the dangers involved with their job activities as well as measures to avert these dangers.
- Make sure all persons tasked with operating, installing, and maintaining the unit have read and understand the safety information and operating instructions.
- When using hazardous materials or materials that could become hazardous, the circulator may be operated only by persons who are absolutely familiar with these materials and the circulator. These persons must be fully aware of possible risks.

If you have any questions concerning the operation of your unit or the information in this manual, please contact us!

**Contact:** JULABO GmbH  
Eisenbahnstraße 45  
77960 Seelbach / Germany

Tel. +49 (0) 7823 / 51-0 [info.de@julabo.com](mailto:info.de@julabo.com)  
Fax +49 (0) 7823 / 24 91 [www.julabo.com](http://www.julabo.com)

### **Safety instructions for the operator:**

- Avoid strikes to the housing, vibrations, damage to the operating-element panel (keypad, display), and contamination.
- Make sure the product is checked for proper condition regularly (depending on the conditions of use). Regularly check (at least every 2 years) the proper condition of the mandatory, warning, prohibition and safety labels.
- Make sure that the mains power supply has low impedance to avoid any negative effects on the instruments being operated on the same mains.
- This unit is designed for operation in a controlled electromagnetic environment. This means that transmitting devices (e.g., cellular phones) should not be used in the immediate vicinity.
- Magnetic radiation may affect other devices with components sensitive to magnetic fields (e.g., monitors). We recommend maintaining a minimum distance of 1 m.
- Permissible ambient temperature: max. 40 °C, min. 5 °C.
- Permissible relative humidity: 50% (40 °C).
- Do not store the unit in an aggressive atmosphere. Protect the unit from contamination.
- Do not expose the unit to sunlight.

### **Appropriate operation**

Only qualified personnel is authorized to configure, install, maintain, or repair the circulator. Persons who operate the circulator must be trained in the particular tasks by qualified personnel. The summarized user guidance (short manual) and the specification table with information on individual parameters are sufficient for this.

### **Use**

The bath can be filled with flammable materials. Fire hazard!

There might be chemical dangers depending on the bath medium used.



Observe all warnings for the used materials (bath fluids) and the respective instructions (safety data sheets).

Insufficient ventilation may result in the formation of explosive mixtures. Only use the unit in well ventilated areas.



Only use recommended materials (bath fluids). Only use non-acid and non corroding materials.

## Operator responsibility – Safety instructions

When using hazardous materials or materials that could become hazardous, **the operator must** affix the enclosed safety labels (**1 + 2**) to the front of the unit so they are highly visible:

1		Warning label W00: Colors: yellow, black Danger area. Attention! Observe instructions. (operating manual, safety data sheet)
2		Mandatory label M018: Colors: blue, white Carefully read the user information prior to beginning operation. <b>Scope: EU</b>
or		
2		Semi S1-0701 Table A1-2 #9 Carefully read the user information prior to beginning operation. <b>Scope: USA, NAFTA</b>

Particular care and attention is necessary because of the wide operating range. There are thermal dangers: Burn, scald, hot steam, hot parts and surfaces that can be touched.

	Warning label W26: Colors: yellow, black Hot surface warning. (The label is put on by JULABO)
	Warning label W017: Colors: yellow, black Low temperature warning. (The label is put on by JULABO)

Observe the instructions in the manuals for instruments of a different make that you connect to the circulator, particularly the corresponding safety instructions. Also observe the pin assignment of plugs and technical specifications of the products.

### 2.1. Disposal

The product may be used with oil as bath fluid. These oils fully or partially consist of mineral oil or synthetic oil. For disposal, follow the instructions in the material safety data sheets.

This unit contains the refrigerants R-404A, and R-134a, which at this time are not considered harmful to the ozone layer. However, over the long operating period of the unit, disposal rules may change. Therefore, only qualified personnel should handle the disposal.



Valid in EU countries

See the current official journal of the European Union – WEEE directive. Directive of the European Parliament and of the Council on waste electrical and electronic equipment (WEEE).

This directive requires electrical and electronic equipment marked with a crossed-out trash can to be disposed of separately in an environmentally friendly manner.

Contact an authorized waste management company in your country.

Disposal with household waste (unsorted waste) or similar collections of municipal waste is not permitted!



## 2.2. EC Conformity

### EG-Konformitätserklärung nach EG Maschinenrichtlinie 2006/42/EG, Anhang II A EC-Declaration of Conformity to EC Machinery Directive 2006/42/EC, Annex II A

**Hersteller / Manufacturer:**

JULABO GmbH  
Eisenbahnstr. 45  
77960 Seelbach / Germany  
Tel: +49(0)7823 / 51 - 0



Hiermit erklären wir, dass das nachfolgend bezeichnete Produkt  
*We hereby declare, that the following product*

**Produkt / Product:** Kryo – Kompakt – Thermostat / *Cryo – Compact – Circulator*

**Typ / Type:** CF30; CF31

**Serien-Nr. / Serial-No.:** siehe Typenschild / *see type label*

aufgrund seiner Konzipierung und Bauart in der von uns in Verkehr gebrachten Ausführung den grundlegenden Sicherheits- und Gesundheitsanforderungen den nachfolgend aufgeführten EG-Richtlinien entspricht.  
*due to the design and construction, as assembled and marketed by our Company – complies with fundamental safety and health requirements according to the following EC-Directives.*

**Maschinenrichtlinie 2006/42/EG; Machinery Directive 2006/42/EC**  
**EMV-Richtlinie 2004/108/EG; EMC-Directive 2004/108/EC**  
**RoHS-Richtlinie 2011/65/EU; RoHS-Directive 2011/65/EU**

#### Angewandte harmonisierte Normen und techn. Spezifikationen:

*The above-named product is in compliance with the following harmonized standards and technical specifications:*

EN 50581 : 2012

Technische Dokumentation zur Beurteilung von Elektro- und Elektronikgeräten hinsichtlich der Beschränkung gefährlicher Stoffe  
*Technical documentation for the assessment of electrical and electronic products with respect to the restriction of hazardous substances*

EN ISO 12100 : 2010

Sicherheit von Maschinen - Allgemeine Gestaltungsleitsätze - Risikobeurteilung und Risikominderung (ISO 12100:2010)  
*Safety of machinery - General principles for design - Risk assessment and risk reduction (ISO 12100:2010)*

EN 61010-1 : 2010

Sicherheitsbestimmungen für elektrische Mess-, Steuer-, Regel- und Laborgeräte, Teil 1: Allgemeine Anforderungen  
*Safety requirements for electrical equipment for measurement, control, and laboratory use, Part 1: General requirements*

EN 61010-2-010 : 2003

Sicherheitsbestimmungen für elektrische Mess-, Steuer-, Regel- und Laborgeräte, Teil 2-010: Besondere Anforderungen an Laborgeräte für das Erhitzen von Stoffen  
*Safety requirements for electrical equipment for measurement, control, and laboratory use, Part 2-010: Particular requirements for laboratory equipment for the heating of materials*

EN 61326-1 : 2013

Elektrische Mess-, Steuer-, Regel- und Laborgeräte- EMV-Anforderungen- Teil 1: Allgemeine Anforderungen  
*Electrical equipment for measurement, control, and laboratory use - EMC requirements - Part 1: General requirements*

EN 378-1 : 2008 + A2 : 2012

Kälteanlagen und Wärmepumpen – Sicherheitstechnische und umweltrelevante Anforderungen – Teil 1: Grundlegende Anforderungen  
*Refrigerating systems and heat pumps - Safety and environmental requirements - Part 1: Basics requirements, definitions, classification and selection criteria*

EN 378-2 : 2008 + A2 : 2012

Kälteanlagen und Wärmepumpen – Sicherheitstechnische und umweltrelevante Anforderungen – Teil 2: Konstruktion, Herstellung, Prüfung, Kennzeichnung und Dokumentation  
*Refrigerating systems and heat pumps - Safety and environmental requirements - Part 2: Design, construction, testing, marking and documentation*

EN 378-3 : 2008 + A1 : 2012

Kälteanlagen und Wärmepumpen – Sicherheitstechnische und umweltrelevante Anforderungen – Teil 3: Aufstellungsort und Schutz von Personen  
*Refrigerating systems and heat pumps - Safety and environmental requirements - Part 3: Installation site and personal protection*

EN 378-4 : 2008 + A1 : 2012

Kälteanlagen und Wärmepumpen – Sicherheitstechnische und umweltrelevante Anforderungen – Teil 4: Betrieb, Instandhaltung, Instandsetzung und Rückgewinnung  
*Refrigerating systems and heat pumps - Safety and environmental requirements - Part 4: Operation, maintenance, repair and recovery*

#### Bevollmächtigter für die Zusammenstellung der techn. Unterlagen:

*Authorized representative in charge of administering technical documentation:*  
Hr. Torsten Kauschke, im Hause / *on the manufacturer's premises as defined above*

#### Die Konformitätserklärung wurde ausgestellt

*The declaration of conformity was issued and valid of*

Seelbach, 10.06.2015

  
M. Juchheim, Geschäftsführer / *Managing Director*

2015\_003\_CF30-CF31\_Kompaktthermostat\_d\_e.docx



**EG-Konformitätserklärung nach EG Maschinenrichtlinie 2006/42/EG, Anhang II A**  
**EC-Declaration of Conformity to EC Machinery Directive 2006/42/EC, Annex II A**

**Hersteller / Manufacturer:**

JULABO GmbH  
Eisenbahnstr. 45  
77960 Seelbach / Germany  
Tel: +49(0)7823 / 51 - 0



Hiermit erklären wir, dass das nachfolgend bezeichnete Produkt  
*We hereby declare, that the following product*

**Produkt / Product:** Kryo – Kompakt – Thermostat / *Cryo – Compact - Circulator*

**Typ / Type:** CF40; CF41

**Serien-Nr. / Serial-No.:** siehe Typenschild / *see type label*

aufgrund seiner Konzipierung und Bauart in der von uns in Verkehr gebrachten Ausführung den grundlegenden Sicherheits- und Gesundheitsanforderungen den nachfolgend aufgeführten EG-Richtlinien entspricht.  
*due to the design and construction, as assembled and marketed by our Company – complies with fundamental safety and health requirements according to the following EC-Directives.*

**Maschinenrichtlinie 2006/42/EG; Machinery Directive 2006/42/EC**  
**EMV-Richtlinie 2004/108/EG; EMC-Directive 2004/108/EC**  
**RoHS-Richtlinie 2011/65/EU; RoHS-Directive 2011/65/EU**

**Angewandte harmonisierte Normen und techn. Spezifikationen:**

*The above-named product is in compliance with the following harmonized standards and technical specifications:*

EN 50581 : 2012

Technische Dokumentation zur Beurteilung von Elektro- und Elektronikgeräten hinsichtlich der Beschränkung gefährlicher Stoffe  
*Technical documentation for the assessment of electrical and electronic products with respect to the restriction of hazardous substances*

EN ISO 12100 : 2010

Sicherheit von Maschinen - Allgemeine Gestaltungsleitsätze - Risikobeurteilung und Risikominderung (ISO 12100:2010)  
*Safety of machinery - General principles for design - Risk assessment and risk reduction (ISO 12100:2010)*

EN 61010-1 : 2010

Sicherheitsbestimmungen für elektrische Mess-, Steuer-, Regel- und Laborgeräte, Teil 1: Allgemeine Anforderungen  
*Safety requirements for electrical equipment for measurement, control, and laboratory use, Part 1: General requirements*

EN 61010-2-010 : 2003

Sicherheitsbestimmungen für elektrische Mess-, Steuer-, Regel- und Laborgeräte, Teil 2-010: Besondere Anforderungen an Laborgeräte für das Erhitzen von Stoffen  
*Safety requirements for electrical equipment for measurement, control, and laboratory use, Part 2-010: Particular requirements for laboratory equipment for the heating of materials*

EN 61326-1 : 2013

Elektrische Mess-, Steuer-, Regel- und Laborgeräte- EMV-Anforderungen- Teil 1: Allgemeine Anforderungen  
*Electrical equipment for measurement, control, and laboratory use - EMC requirements - Part 1: General requirements*

EN 378-1 : 2008 + A2 : 2012

Kälteanlagen und Wärmepumpen – Sicherheitstechnische und umweltrelevante Anforderungen – Teil 1: Grundlegende Anforderungen  
*Refrigerating systems and heat pumps - Safety and environmental requirements - Part 1: Basics requirements, definitions, classification and selection criteria*

EN 378-2 : 2008 + A2 : 2012

Kälteanlagen und Wärmepumpen – Sicherheitstechnische und umweltrelevante Anforderungen – Teil 2: Konstruktion, Herstellung, Prüfung, Kennzeichnung und Dokumentation  
*Refrigerating systems and heat pumps - Safety and environmental requirements - Part 2: Design, construction, testing, marking and documentation*

EN 378-3 : 2008 + A1 : 2012

Kälteanlagen und Wärmepumpen – Sicherheitstechnische und umweltrelevante Anforderungen – Teil 3: Aufstellungsort und Schutz von Personen  
*Refrigerating systems and heat pumps - Safety and environmental requirements - Part 3: Installation site and personal protection*

EN 378-4 : 2008 + A1 : 2012

Kälteanlagen und Wärmepumpen – Sicherheitstechnische und umweltrelevante Anforderungen – Teil 4: Betrieb, Instandhaltung, Instandsetzung und Rückgewinnung  
*Refrigerating systems and heat pumps - Safety and environmental requirements - Part 4: Operation, maintenance, repair and recovery*

**Bevollmächtigter für die Zusammenstellung der techn. Unterlagen:**

**Authorized representative in charge of administering technical documentation:**

Hr. Torsten Kauschke, im Hause / *on the manufacturer's premises as defined above*

**Die Konformitätserklärung wurde ausgestellt**

*The declaration of conformity was issued and valid of*

Seelbach, 10.06.2015

  
M. Juchheim, Geschäftsführer / *Managing Director*

2015\_004\_CF40-CF41\_Kompaktthermostat\_d\_e.docx



### 2.3. Warranty conditions

JULABO GmbH warrants its products against defects in material or in workmanship, when used under appropriate conditions and in accordance with appropriate operating instructions

**for a period of ONE YEAR.**

**Extension of the warranty period – free of charge**



With the '1PLUS warranty' the user receives a free of charge extension to the warranty of up to 24 months, limited to a maximum of 10 000 working hours.

To apply for this extended warranty the user must register the unit on the JULABO web site [www.julabo.com](http://www.julabo.com), indicating the serial no. The extended warranty will apply from the date of JULABO GmbH's original invoice.

JULABO GmbH reserves the right to decide the validity of any warranty claim. In case of faults arising either due to faulty materials or workmanship, parts will be repaired or replaced free of charge, or a new replacement unit will be supplied.

Any other compensation claims are excluded from this guarantee.

## 2.4. Technical specifications

				CF30
Working temperature range		°C	-30 ... +150	
Temperature stability		°C	±0.03	
Temperature selection			digital	
via keypad			indication on LED-DISPLAY	
remote control via personal computer			indication on monitor	
Temperature indication:			LED-DISPLAY	
Resolution		°C	0.1	
Temperature control			PID 1	
Working temperature sensor			Pt 100	
Safety temperature sensor			Pt 100	
Heater wattage	(at 230 V)	kW	2,0	
Heater wattage	(at 115 V)	kW	1,0	
Cooling capacity		°C	<u>20</u> 0 <u>-20</u>	
Medium ethanol		kW	0.32   0.25   0.15	
Cooling compressor			1-stage	
Refrigerant			R134a	
Cooling machine			Air-cooled	
Electrical connections:				
Computer interface			RS232	
Pump capacity:				
Flow rate max.	at 0 bar	l/min	15	
Pressure max.	at 0 liter	bar	0,35	
Bath opening (WxL)		cm	16x3	
Bath depth		cm	14	
Filling volume		liters	2.0 ... 3.0	
Overall dimensions (WxDxH)		cm	24x46x40	
Weight		kg	35	
Ambient temperature		°C	5 ... 40	
Protection class according to IEC 60 529			IP 21	
Mains power connection	230 V/50 Hz	V/ Hz	207-253 / 50	
Current draw (at 230 V)		A	10	
Mains power connection	230 V/60 Hz	V/ Hz	207-253 / 60	
Current draw (at 230 V)		A	11	
Mains power connection	115 V/60 Hz	V/ Hz	103-127 / 60	
Current draw (at 115 V)		A	13	

All measurements have been carried out at: rated voltage and frequency  
 ambient temperature: 20 °C      Technical changes without prior notification reserved.

			CF40
Working temperature range	°C		-40 ... +150
Temperature stability	°C		±0.03
Temperature selection			digital
via keypad			indication on LED-DISPLAY
remote control via personal computer			indication on monitor
Temperature indication:			LED-DISPLAY
Resolution	°C		0.1
Temperature control			PID 1
Working temperature sensor			Pt 100
Safety temperature sensor			Pt 100
Heater wattage	(at 230 V)	kW	2,0
Heater wattage	(at 115 V)	kW	1,0
Cooling capacity	°C		<u>20</u> 0    -20    -30
Medium ethanol		kW	0.47   0.4   0.28   0.12
Cooling compressor			1-stage
Refrigerant			R404A
Cooling machine			Air-cooled
Electrical connections:			
Computer interface			RS232
Pump capacity:			
Flow rate max.	at 0 bar	l/min	15
Pressure max.	at 0 liter	bar	0,35
Bath opening (WxL)		cm	19x3
Bath depth		cm	19
Filling volume		liters	4.0 ... 5.5
Overall dimensions (WxDxH)		cm	28x46x46
Weight		kg	41
Ambient temperature	°C		5 ... 40
Protection class according to IEC 60 529			IP 21
Mains power connection	230 V/50 Hz	V/ Hz	207-253 / 50
Current draw (at 230 V)		A	12
Mains power connection	230 V/60 Hz	V/ Hz	207-253 / 60
Current draw (at 230 V)		A	12
Mains power connection	115 V/60 Hz	V/ Hz	103-127 / 60
Current draw (at 115 V)		A	16

All measurements have been carried out at: rated voltage and frequency  
 ambient temperature: 20 °C      Technical changes without prior notification reserved.

### Warning functions and safety installations

Excess temperature protection	adjustable from 0 °C ... 220 °C
Low liquid level protection	float switch
Classification according to DIN 12876-1	class III
Alarm message	optical + audible (permanent)
Warning message	optical + audible (in intervals)
Overload protection	for compressor and pump motor
Supervision of working sensor	plausibility control
Reciprocal sensor monitoring between working and safety sensors	difference >35 K

### Environmental conditions according to IEC 61 010-1:

Use indoors only.

Altitude up to 2000 m - normal zero.

Ambient temperature: see Technical specifications

Humidity:

Max. relative humidity 80% for temperatures up to +31 °C,

linear decrease down to 50% relative humidity at a temperature of +40 °C

Max. mains voltage fluctuations of ±10% are permissible.

Protection class according to IEC 60 529      IP21

The unit corresponds to Class I

Overvoltage category      II

Pollution degree      2



#### **Caution:**

The unit is not suitable for use in explosive atmosphere

EMC requirements according to EN 61326-1

This unit is an ISM device classified in Group 1 (using high frequency for internal purposes), Class A (industrial and commercial range).



### 3. Safety notes for the user

#### 3.1. Explanation of safety notes



In addition to the safety warnings listed above, warnings are posted throughout the manual. These warnings are designated by an exclamation mark inside an equilateral triangle. "Warning of a dangerous situation (Attention! Please follow the documentation)."

The danger is classified using a signal word.  
Read and follow these important instructions.



**Warning:**

Describes a possibly highly dangerous situation. If these instructions are not followed, serious injury and danger to life could result.



**Caution:**

Describes a possibly dangerous situation. If this is not avoided, slight or minor injuries could result. A warning of possible property damage may also be contained in the text.



**Notice:**

Describes a possibly harmful situation. If this is not avoided, the product or anything in its surroundings can be damaged.

#### 3.2. Explanation of other notes



**Note!**

Draws attention to something special.



**Important!**

Indicates usage tips and other useful information.

#### 3.3. Safety instructions

Follow the safety instructions to avoid personal injury and property damage. Also, the valid safety instructions for workplaces must be followed.



- Only connect the unit to a power socket with an earthing contact (PE – protective earth)!
- The power supply plug serves as a safe disconnecting device from the line and must always be easily accessible.
- Place the unit on an even surface on a base made of nonflammable material.
- Do not stay in the area below the unit.
- Make sure you read and understand all instructions and safety precautions listed in this manual before installing or operating your unit.
- Set the excess temperature safety installation at least 25 °C below the fire point of the bath fluid.

- Never operate the unit without bath fluid in the bath.
- Pay attention to the thermal expansion of bath oil during heating to avoid overflowing of the fluid.
- Prevent water from entering the hot bath oil.
- Do not drain the bath fluid while it is hot!  
Check the temperature of the bath fluid prior to draining (e.g., by switching the unit on for a short moment).
- Use suitable connecting tubing.
- Avoid sharp bends in the tubing, and maintain a sufficient distance from surrounding walls.
- Make sure that the tubing is securely attached.
- Regularly check the tubing for material defects (e.g., for cracks).
- Never operate damaged or leaking units.
- Always turn off the unit and disconnect the mains cable from the power source before performing any service or maintenance procedures, or before moving the unit.
- Always turn off the unit and disconnect the mains cable from the power source before cleaning the unit.
- Always empty the bath before moving the unit.
- Transport the unit with care.
- Sudden jolts or drops may cause damage in the interior of the unit.
- Observe all warning labels.
- Never remove warning labels.
- Never operate units with damaged mains power cables.
- Repairs are to be carried out only by qualified service personnel.



- Some parts of the bath tank and the pump connections may become extremely hot during continuous operation. Therefore, exercise particular caution when touching these parts.



- Some parts of the bath tank and the pump connections may become extremely cold during continuous operation. Therefore, exercise particular caution when touching these parts.

**Caution:**

The circulator may be used, for example, to control the temperature of fluids in a reactor.

We do not know what substances are contained in these vessels.

Many substances are:

- inflammable, easily ignited, or explosive
- hazardous to health
- environmentally hazardous

i.e.: **dangerous**

**The user alone is responsible for the handling of these substances!**

The following questions should help to recognize possible dangers and to reduce the risks to a minimum.

- Are all tubes and electrical cables connected and layed?  
Note:  
sharp edges, hot surfaces in operation, moving machine parts, etc.
- Do dangerous vapors or gases develop during heating?  
Must the work be done in a fume hood?
- What to do when a dangerous substance was spilled on or in the unit?  
Before starting to work, obtain information concerning the substance and determine the method of decontamination.

**Notice:**

Check the safety installations at least twice a year!

- Excess temperature protection according to IEC 61010-2-010  
With a screwdriver, turn back the adjustable excess temperature protection until the shutdown point (actual temperature).
- Low level protection according to IEC 61010-2-010  
To check the function of the float, it can be manually lowered with a screwdriver, for example.

## Operating instructions







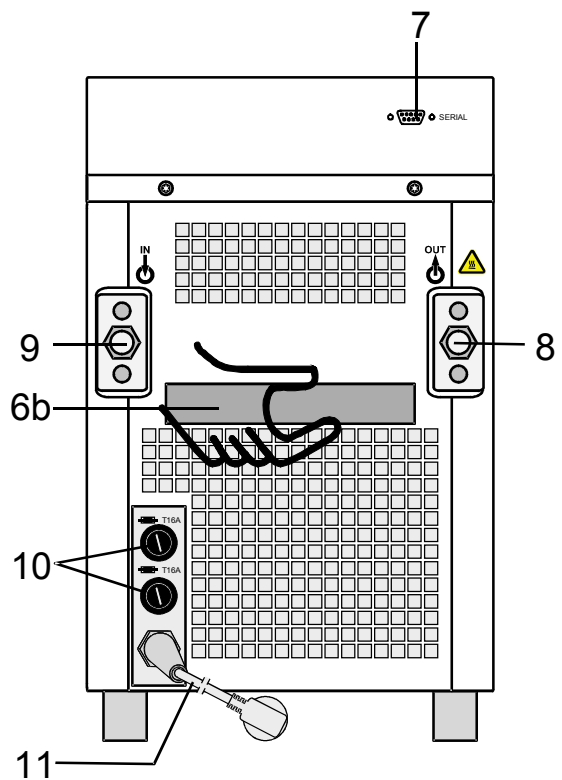
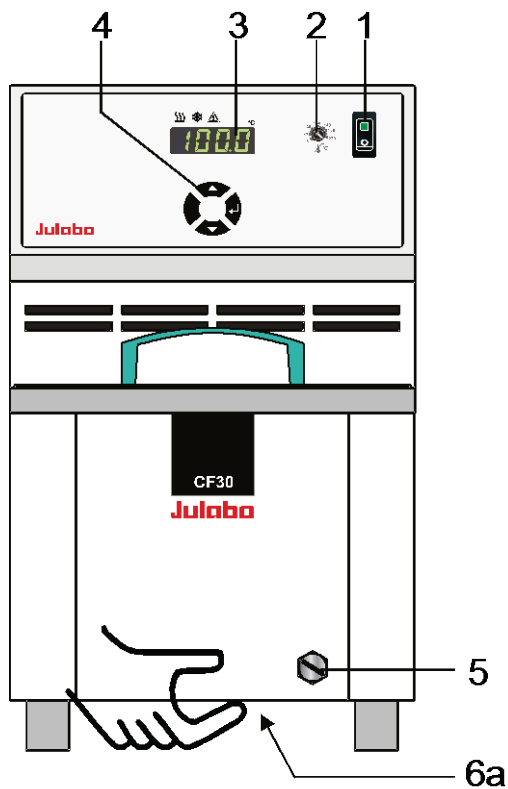
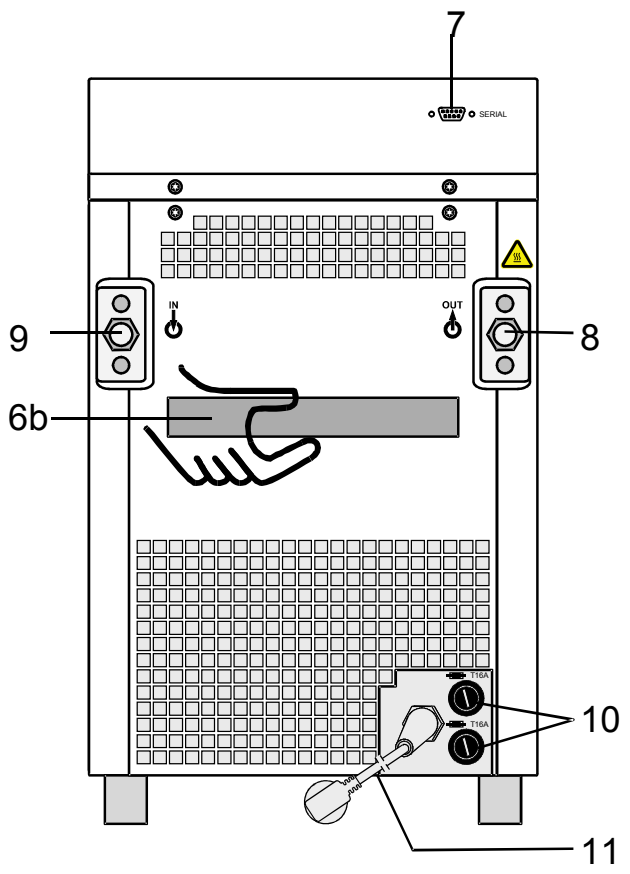
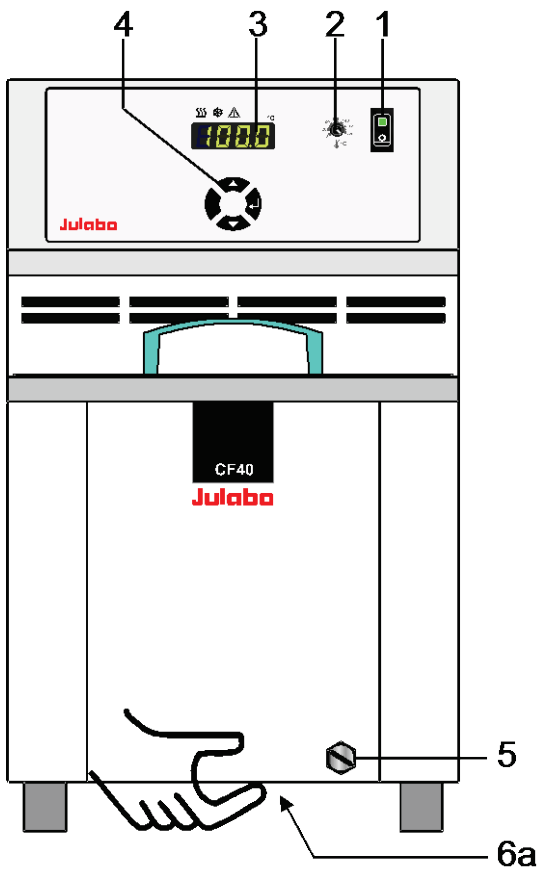









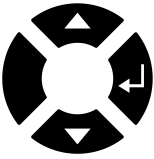

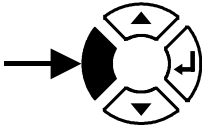
### 4. Operating controls and functional elements

Front view CF40 / CF30

Rear view CF40/ CF30





- 1  Mains power switch, illuminated
  
- 2  Adjustable excess temperature protection according to IEC 61010-2-010
  
- 3.0 **Indication**
- 3.1  LED temperature display
- 3.2  Control indicator – Heating
- 3.3  Control indicator – Cooling
- 3.4  Control indicator – Alarm
  
- 4.0 **Keypad** splash-water protected
-  Edit keys (set point increase or decrease)
-  Enter key Store set point value / parameter
-  Escape key
  - 1. Cancel entries
  - 2. Switch over LED temperature display
  
- 5  Drain port
  
- 6a  Handle: front
- 6b  Handle: rear
  
- 7  SERIAL Interface RS232: remote control via personal computer
  
- 8  Pump connector M16x1:  - Feed
- 9  Pump connector M16x1:  - Return
  
- 10  Mains fuses, T16A
  
- 11  Mains power cable with plug

## 5. Preparations

### 5.1. Installation

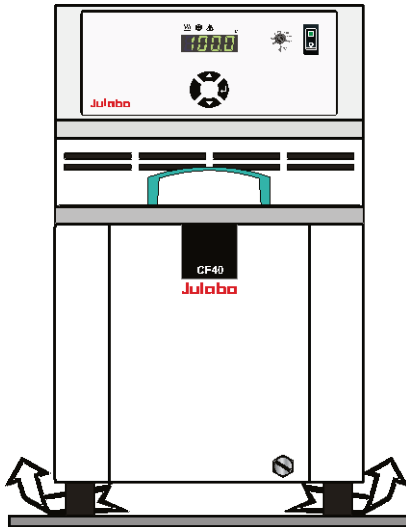

- Place the unit on an even surface on a base made of **nonflammable** material.
- Cooling machine, pump motor and electronics produce intrinsic heat that is dissipated via the venting openings.! Never cover these openings!
- Be sure that the flow of ventilation can exit under the instrument.
- Keep at least 20 cm of open space on the front and rear venting grids
- The place of installation should be large enough and provide sufficient air ventilation to ensure the room does not warm up excessively because of the heat the instrument rejects to the environment. (Max. permissible ambient temperature: 35 °C).

For a fault (leakage) in the refrigeration system, the standard EN 378 prescribes a certain room space to be available for each kg of refrigerant.

The refrigerant quantity is specified on the type plate.

> For 0.52 kg of refrigerant R404A, 1 m<sup>3</sup> of space is required.

> For 0.25 kg of refrigerant R134a, 1 m<sup>3</sup> of space is required.

Model CF40 with 0.16 kg filling quantity of refrigerant R404A = 0,33 m<sup>3</sup> volume

Model CF30 with 0.15 kg filling quantity of refrigerant R134a = 0.6 m<sup>3</sup> volume

- Do not install the unit in the immediate vicinity of heat sources and do not expose it to sunlight.
- Before operating the unit after transport, wait about one hour after installation. This will allow any oil that has accumulated laterally during transport to flow back down, thus ensuring that the compressor can develop its maximum capacity.

## 5.2. Temperature application to external, closed systems

The Cryo-Compact Circulator is used for temperature application to external, closed systems (loop circuit)



**Caution:** Securely attach all tubing to prevent slipping.



**Notice:** Flood hazard!

If the liquid levels in the Cryo-Compact Circulator bath and the external system are at different heights, overflowing must be prevented after the power has been turned off.

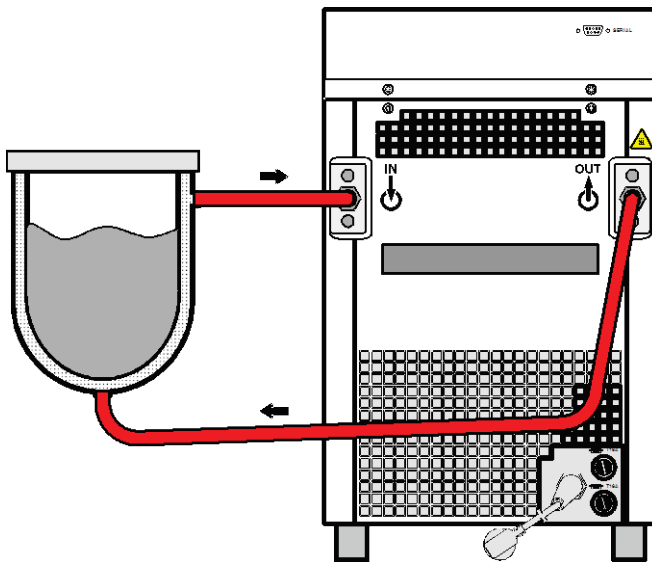

- Unscrew the M16x1 collar nuts on the pump connectors with a 19 mm (3/4") wrench and remove the sealing disks. Using the collar nuts, screw on the tubing connection fittings (for tubing 8 mm or 12 mm in diameter) delivered with the unit and tighten firmly. (Pressure pump: 8, Return: 9)
- Push on the tubings, and secure with tube clamps.
- Attach the tubing to the connectors of the external closed system, e.g., an instrument with a pressure-resistant temperature jacket or a temperature coil, and fasten with tube clamps to prevent slipping.

Tubing see page 20

### Return flow safety device

For this reason, shut-off valves can be integrated in the loop circuit.

Order No.	Description
8 970 456	Shut-off valve (suitable up to +90 °C)
8 970 457	Shut-off valve (suitable up to +200 °C)

### 5.3. Tubing



**Warning:** Tubing:

At high working temperatures, the tubing used for temperature control and for the cooling water supply represents a danger source.

A damaged tubing line may allow a large amount of hot bath fluid to be pumped out within a short time.

**This may result in:**

- Burning of skin
- Breathing difficulties due to hot atmosphere

**Safety instructions**

- Use suitable connecting tubing.
- Make sure that the tubing is securely attached.
- Avoid sharp bends in the tubing and maintain a sufficient distance from surrounding walls.
- Regularly check the tubing for material defects (e.g., for cracks), at least once a year.
- Preventive maintenance: replace the tubing from time to time.

**Recommended tubing:**

Order No.		Suitable for
8930008	1 m CR <sup>®</sup> -tubing 8 mm inner dia. (-20 ... +120°C)	CF30, CF40
8930012	1 m CR <sup>®</sup> -tubing 12 mm inner dia. (-20 ... +120°C)	CF30, CF40
8930108	1 m Viton <sup>®</sup> tubing 8 mm inner dia (-50 °C ... 200 °C)	CF30, CF40
8930112	1 m Viton <sup>®</sup> tubing 12 mm inner dia (-50 °C ... 200 °C)	CF30, CF40

**Tubing insulation**

8930410	1 m Insulation, 14 mm inner dia..	CR <sup>®</sup> -tubing 8 mm inner dia
8930412	1 m Insulation, 18 mm inner dia.	Viton <sup>®</sup> tubing 12 mm inner dia.

**Tube clamps**

8970480	2 Tube clamps, size 1	CR <sup>®</sup> -tubing 8 mm inner dia
8970481	2 Tube clamps, size 2	Viton <sup>®</sup> tubing 12 mm inner dia.

**Metal tubing, flexible, triple insulated**

8 930 209	0.5 m	2 fittings M16x1 female	-100 °C ... +350 °C
8 930 210	1.0 m		
8 930 211	1.5 m		
8 930 214	3.0 m		

**Metal tubing, flexible, insulated**

8 930 220	0.5 m	2 fittings M16x1 female	-50 °C to +200 °C
8 930 221	1.0 m		
8 930 222	1.5 m		
8 930 223	3.0 m		



## 5.4. Bath fluids



### **Caution:**

Carefully read the material safety data sheet of the bath fluid used, particularly with regard to the fire point!

If a bath fluid with a fire point of  $\leq 65$  °C is used, only supervised operation is possible.

### **Water:**

The quality of water depends on local conditions.

- Due to the high concentration of lime, hard water is not suitable for temperature control because it leads to scale in the bath
- Ferrous water can cause corrosion, even on stainless steel.
- Chlorinated water can cause pitting corrosion.
- Distilled water and deionized water are unsuitable. Their special properties cause corrosion in the bath, even on stainless steel.

### Recommended bath fluids:

Bath fluid	Temperature range
soft/decalcified water	5 °C to 80 °C



See website for list of recommended bath fluids.

**Contact:** see page 5



### **Caution:**

#### **Fire or other dangers when using bath fluids that are not recommended:**

Please contact JULABO before using other than recommended bath liquids. JULABO assumes no liability for damage caused by the selection of an unsuitable bath fluid.

Unsuitable bath fluids are fluids which, e.g.,

- are highly viscous  
(much higher than 30 mm<sup>2</sup>/s at the respective working temperature)
- have a low viscosity and have creep characteristics
- have corrosive characteristics or
- tend to crack.

#### **No liability for use of other bath fluids!**

ATTENTION: The maximum permissible viscosity is 30 mm<sup>2</sup>/s

## 6. Operating procedures

### 6.1. Power connection



#### Caution:

- Only connect the unit to a power socket with an earthing contact (PE – protective earth)!
- The power supply plug serves as a safe disconnecting device from the line and must always be easily accessible.
- Never operate the unit with a damaged mains power cable.
- Regularly check the mains power cables for damage.
- We disclaim all liability for damage caused by incorrect line voltages!

Make sure that the line voltage and frequency match the supply voltage specified on the type plate.

### 6.2. Filling



#### Notice:

Pay attention to the thermal expansion of bath oil during heating to avoid overflowing of the liquid.

#### Guideline:

A volume change of 12 % per 100 °C temperature variation is to be considered.

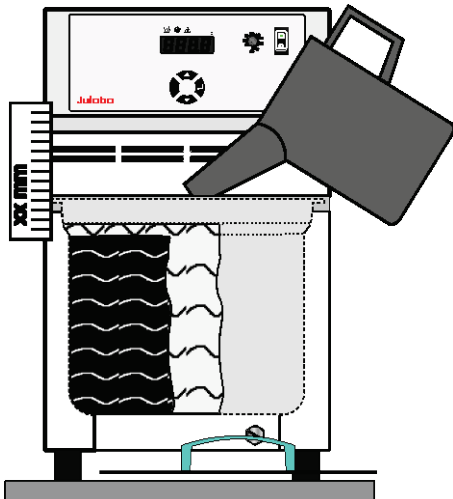

Take care that no liquid enters the interior of the Cryo-compact circulator.

- ① Connect the tubing from the external system to the pump connectors and check for leaks.
- ① Check to make sure that the drain tap (7) is closed.

#### Recommendation:

For filling, use for example an measuring jug with nuzzle.

- ① Recommended maximum filling level with water as bath fluid:  
30 mm below the tank rim
- ① Recommended maximum filling level with bath oils:  
40 mm below the tank rim

- Turn the mains switch (1) on  
(Switching on - see page 24)
- Switch on unit. To do so press button  for approx. 4 seconds.
- Tempering fluid is pumped into the externally connected system.  
Refill fluid.
- The Cryo-Compact Circulator is ready for operation.

**Important:**

- ① When using a bath fluid, the change in volume in case of change in temperature has to be respected. Fill in a little amount of bath fluid only so that the low level alarm is not triggered.
- ① Low level alarm is triggered at the following liquid level:
  - CF30 75 to 80 mm below the tank rim
  - CF40 80 to 85 mm below the tank rim
- ① When reaching the working temperature, check the liquid level. If the cooling coil is not completely covered with bath fluid, refill it.

### 6.3. Switching on / Start - Stop

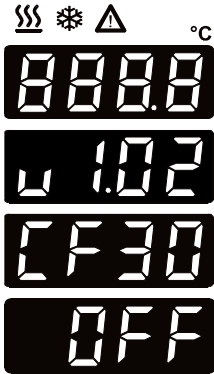

#### Switching on:



- The Cryo-Compact Circulator is turned on and off with the mains switch.

① The unit performs a self-test. All segments of the 4-digit LED temperature DISPLAY and all indicator lights will illuminate (as illustrated on the left).

Then the software version and the type of unit is indicated.  
Examples: (v 1.02) (CF30)

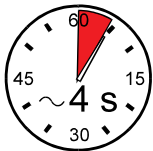
The display "OFF" indicates the unit is ready to operate (standby mode).



- Start:** Press enter  for about 4 seconds.  
The LED temperature DISPLAY indicates the actual bath temperature.
- Stop:** Press enter  for about 4 seconds.  
Turn the unit off with the mains power switch.

### 6.4. ① Control of the cooling machine

With the mains switch turned on, the circulator automatically switches the cooling machine off and on.

To ensure protection of the compressor, the software only switches the compressor on after a delay of 200 seconds.

It is switched off, if:

- at internal control >Int<  
the setpoint temperature is increased and the heat-up time calculated by the controller is longer than the intended time of compressor standstill (200 s).
- at external control >EXT<  
the actual working temperature is increased by >5 °C

It is switched on, if:

- cooling is necessary for maintaining the bath temperature. (possibly after the 200 s time delay).



## 6.5. Setting the temperatures

- ① Setting can be carried out in the start/stop condition.
1. Press one of the keys ▼ ▲ for a short moment.  
The setpoint value instead of the actual value is indicated on the display for about 8 seconds.  
The value can now be changed.
  2. Change value:  
Press ▲ to set a higher value.  
Press ▼ to set a lower value.  
Keep the keys depressed for the value to change fast.
  3. Press enter ↵ to store the value.

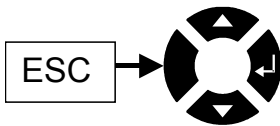

- ① Press ESC to update the display immediately, or the unit automatically returns to the effective display after about 30 seconds 🕒.

## 6.6. AUTOSTART ON / OFF

The Cryo-Compact Circulator has been configured and supplied by JULABO according to N.A.M.U.R. recommendations. This means for the start mode, that the unit must enter a safe operating state after a power failure (non-automatic start mode). This safe operating state is indicated by „OFF“ on the LED temperature display. A complete shutdown of the main functional elements such as compressor and circulating pump is effected simultaneously.

Should such a safety standard not be required, the AUTOSTART function (automatic start mode) may be activated, thus allowing the start of the Cryo-compact circulator directly by pressing the mains power switch or using a timer.

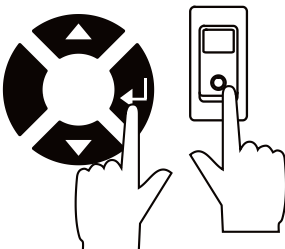

1. Keep depressed enter ↵ and
2. turn on the unit with the mains power switch.

For a short while the LED DISPLAY indicates the effective start mode:

**AOn** ⇒ AUTOSTART on.

**AOff** ⇒ AUTOSTART off.



**Warning:**

For supervised or unsupervised operation with the AUTOSTART function, avoid any hazardous situation to persons or property.  
The Cryo-compact circulator does no longer conform to N.A.M.U.R. recommendations.

**6.7. Remote control: activate – deactivate**

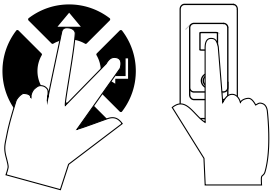

The Cryo-Compact Circulator is to be prepared for remote control by a personal computer via the serial interface RS232.

Set the interface item

from >IOFF< (Interface OFF)  
to >ION< (Interface On).

(Interface OFF)



(Interface On)



**Remote control: activate – deactivate:**

- Switch off the Cryo-Compact Circulator by pressing the mains switch and wait approx. 5 seconds.
- Keep depressed the keys ▲ and enter ↵ simultaneously and turn on the unit with the mains power switch.

>I OFF< No remote control via RS232 (Factory setting)

>I On< Remote control via RS232

ⓘ The software version and the type of unit is indicated (see example on the left).

The display "r OFF" indicates the unit is ready to be operated via remote control.

## 7. Safety installations



Check the safety installations at least twice a year! (See page 15)

### 7.1. Excess temperature protection



#### Warning:



The excess temperature protection >SafeTemp< should be set at least 25 °C below the fire point of the bath fluid used.

In the event of wrong setting there is a fire hazard!

We disclaim all liability for damage caused by incorrect settings!

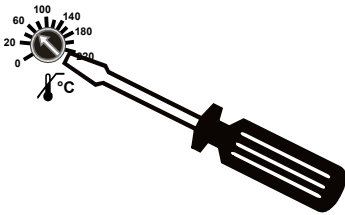
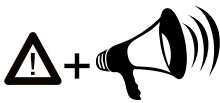

This safety installation is independent of the control circuit.

When the temperature of the bath fluid has reached the safety temperature, a complete shutdown of the heater and pump is effected. The alarm is indicated by optical and audible signals (continuous tone) and on the LED-DISPLAY appears the error message "Error 14".

**Setting range:** 0 °C to 220 °C

- Using a screwdriver turn the setting screw to the desired value.

#### Recommendation:

Set the excess temperature protector at 5 to 10 °C above the working temperature setpoint.

### 7.2. Low level protection



This safety installation is independent of the control circuit.

If the low liquid level protection device is triggered, a complete shutdown of the compressor and circulating pump is effected.

The alarm is indicated by optical and audible signals (continuous tone) and on the LED-DISPLAY appears the error message "Error 01".

- ① Turn off the unit with the mains switch, add bath fluid, and turn the unit on again!



#### Caution:

When adding bath fluid, always use the same bath fluid type that is already in the bath.

Bath oils must not contain any water and should be pre-heated approximately to the current bath temperature!

Explosion hazard at high temperatures!

## 8. Troubleshooting guide / Error messages

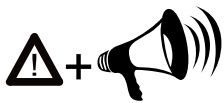

Whenever the microprocessor electronics registers a failure, a complete shutdown of the compressor and circulating pump is performed. The alarm light "▲" illuminates and a continuous signal tone sounds. The LED temperature display indicates the cause for the alarm in form of a code.



Press enter  to quit the audible signal.

**E 01**

- The Cryo-Compact Circulator is operated without bath fluid, or the liquid level is insufficient. Replenish the bath tank with the bath fluid.
- Tube breakage has occurred (insufficient filling level due to excessive bath fluid pumped out). Replace the tubing and replenish the bath tank with the bath fluid.

**E 05**

- Cable of the working temperature sensor interrupted or short-circuited.

**E 06**

- Defect of the working or excess temperature sensor. Working temperature and excess temperature sensors report a temperature difference of more than 35 K.

**E 12**

- Error in A/D converter

**E 14**

- The excess temperature value lies below the working temperature setpoint. Set the excess temperature to a higher value.

**E 33**

- Cable of the excess temperature sensor interrupted or short-circuited.

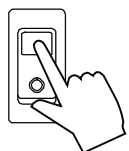

### Cancel the alarm state.

Press the mains power switch off. After eliminating the malfunction, press the mains power on again to cancel the alarm state. If the unit cannot be returned to operation, contact an authorized service station.

**E 20**

### Warning without a complete shutdown of the unit:

- Cooling of the condenser is affected. Clean air-cooled condenser. (see page 36).



- ① This message appear every 4 seconds.  
An acoustic signal sounds in regular intervals.
- Compressor does not work.  
After a short cooling interval, the compressor motor will be automatically reconnected and the message "E 21" no longer appears.
- Even after short switch off and switch on of the device by pressing the main power switch, the compressor might start up after a slight delay.  
Error message E21 will also appear during that time.

If the unit cannot be returned to operation, contact an authorized JULABO service station.

### **Disturbances that are not indicated.**

Overload protection::      a) for cooling machine  
   b) for pump motor

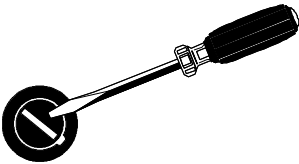

### **Mains fuses:**

The mains fuses on the rear of the unit may easily be exchanged as shown on the left.

Fine fuses (16a)– T 16 A, 250 V~ , D5 x 20 mm



### **Warning:**

Before exchanging the fuses, turn off the mains power switch and disconnect the power plug from the mains socket!

Only use fine fuses with a nominal value as specified.

Example:

Manufacturer	Supplier	Type	Order No.
Schurter	Schurter	G-fuse insert SPT T16A 5x20mm	No. 0001.2516



## 9. Electrical connections



**Notice:**

Use shielded cables only.

The shield of the connecting cable is electrically connected to the plug housing.

The unit ensures safe operation if connecting cables with a maximum length of 3 m are used. The use of longer cables does not affect proper performance of the unit, however external interferences may have a negative impact on safe operation.

### RS232 serial interface

This port can be used to connect a computer with an RS232 cable for remote control of the Cryo-compact circulator .

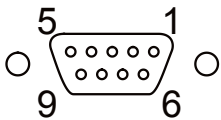

#### Pin assignments RS232:

Pin 2	RxD	Receive Data
Pin 3	TxD	Transmit Data
Pin 5	0 V	Signal GND
Pin 7	RTS	Request to send
Pin 8	CTS	Clear to send

Pin 1; 4; 6, 9 Reserved - do not use!

#### Accessories:

Order No.	Description
8 980 073	RS232 interface cable 9-pol./9-pol. , 2,5 m
8 900 110	USB interface adapter cable

## 10. Remote control

### 10.1. Setup for remote control



1. Check the interface parameters for both interfaces (on Cryo-Compact Circulator and PC) and make sure they match.
2. Set the interface item from >IOFF< to >ION<.
3. Connect both units with an interface cable.

#### Interface parameters are pre-determined.

BAUDRATE	4800 Bauds
PARITY	even
HANDSHAKE	hardware handshake

### 10.2. Communication with a PC or a superordinated data system



If the Cryo-Compact Circulator is put into remote control mode the MULTI-DISPLAY (LED) will read „R -OFF-„ = REMOTE STOP. The Cryo-Compact Circulator is now operated via the computer. In general, the computer (master) sends commands to the recirculating cooler (slave). The recirculating cooler sends data (including error messages) only when the computer sends a query.



In remote control mode:

After a power interruption the order to start and all values which have to be adjusted must be resent from the personal computer via the interface. AUTOSTART is not possible.

A transfer sequence consists of:

- command OUT/IN command
- space ( $\leftrightarrow$ ; Hex: 20) OUT/IN command
- parameter (the character separating decimals in a group is the period) OUT command
- end of file ( $\leftarrow$ ; Hex: 0D) OUT/IN command

- The response (data string) after an **in** command is always followed by a line feed (LF, Hex: 0A).



**Important times for a command transmission:**

To ensure a safe data transfer, the time gap between two commands should be at least 250 ms.

The Cryo-Compact Circulator automatically responds to an **in** command with a data string followed by a LF (Line Feed). The next command should only be sent after 10 ms.

The commands are divided into **in** or **out** commands.

**in** commands: asking for parameters to be displayed

**out** commands: setting parameters



The **out** commands are valid only in remote control mode.

Examples:

Command to set the working temperature to 15,5 °C:

**out\_sp\_00 ⇔ 15.5↵**

Command to ask for the working temperature

**in\_sp\_00↵**

Response from the recirculating cooler:

**15.5↵ LF**

**10.3. List of commands**

**OUT commands:** Setting parameters or temperature values.

Command	Parameter	Response of recirculating cooler
OUT_MODE_05	0	Stop the unit = R –OFF-.
OUT_MODE_05	1	Start the unit.
OUT_SP_00	xxx.xx	Set working temperature

<b>IN commands:</b> Asking for parameters or temperature values to be displayed.
--

Command	Parameter	Response of recirculating cooler
VERSION	none	Number of software version (V X.xx)
STATUS	none	Status message, error message (see page 33 )
IN_PV_00	none	Actual bath temperature.
IN_PV_01	none	Heating power being used (%).
IN_PV_03	none	Temperature value registered by the safety sensor.
IN_PV_04	none	Setpoint temperature of the excess temperature protection
IN_SP_00	none	Working temperature
IN_MODE_05	none	Cryo-Compact Circulator in Stop/Start condition: 0 = Stop 1 = Start

#### 10.4. Status messages

Status messages	Description
<b>00 MANUAL STOP</b>	Cryo-compact circulator in „OFF“ state.
<b>01 MANUAL START</b>	Cryo-compact circulator in keypad control mode.
<b>02 REMOTE STOP</b>	Cryo-compact circulator in „r OFF“ state.
<b>03 REMOTE START</b>	Cryo-compact circulator in remote control mode.

#### 10.5. Error messages

Error messages	Description
<b>-01 LOW LEVEL ALARM</b>	Low liquid level alarm.
<b>-05 WORKING SENSOR ALARM</b>	Working temperature sensor short-circuited or interrupted.
<b>-06 SENSOR DIFFERENCE ALARM</b>	Sensor difference alarm. Working temperature and safety sensors report a temperature difference of more than 35 K.
<b>-07 I<sup>2</sup>C-BUS ERROR</b>	Internal error when reading or writing the I <sup>2</sup> C bus.
<b>-08 INVALID COMMAND</b>	Invalid command.

Error messages	Description
<b>-09 COMMAND NOT ALLOWED IN CURRENT OPERATING MODE</b>	Invalid command in current operating mode.
<b>-10 VALUE TOO SMALL</b>	Entered value too small.
<b>-11 VALUE TOO LARGE</b>	Entered value too large.
<b>-12 TEMPERATURE MEASUREMENT ALARM</b>	Error in A/D converter.
<b>-14 EXCESS TEMPERATURE PROTECTOR ALARM</b>	Excess temperature protection alarm 
<b>-20 WARNING: CLEAN CONDENSOR OR CHECK COOLING WATER CIRCUIT OF REFRIGERATOR</b>	Cooling of the condenser is affected. Clean air-cooled condenser.
<b>-21 WARNING: COMPRESSOR STAGE 1 DOES NOT WORK</b>	Compressor does not work.
<b>-33 SAFETY SENSOR ALARM</b>	Excess temperature sensor short-circuited or interrupted.

## 11. JULABO Service – Online remote diagnosis

JULABO Cryo-compact circulator s of the HighTech series are equipped with a so-called black box. This box is implemented in the controller and records all significant data for the last 30 minutes.

In case of a failure, this data can be read out from the unit by using special software. The respective program is available for **free** download from [www.julabo.com](http://www.julabo.com) \ EasyBlackBox.

- Installation is easy and carried out step by step. Please observe the instructions.



- Data read-out is possible in the conditions „OFF“, „R OFF“ or „ALARM“.
- Connect the Cryo-compact circulator to the computer using an interface cable.
- Start the EasyBlackBox program. The program asks for the used port (COM1, ..... ) and the baud rate of the unit. You do not have this information on hand? Simply try it out! The program keeps on sending this request until the actually used port and correct baud rate are entered.

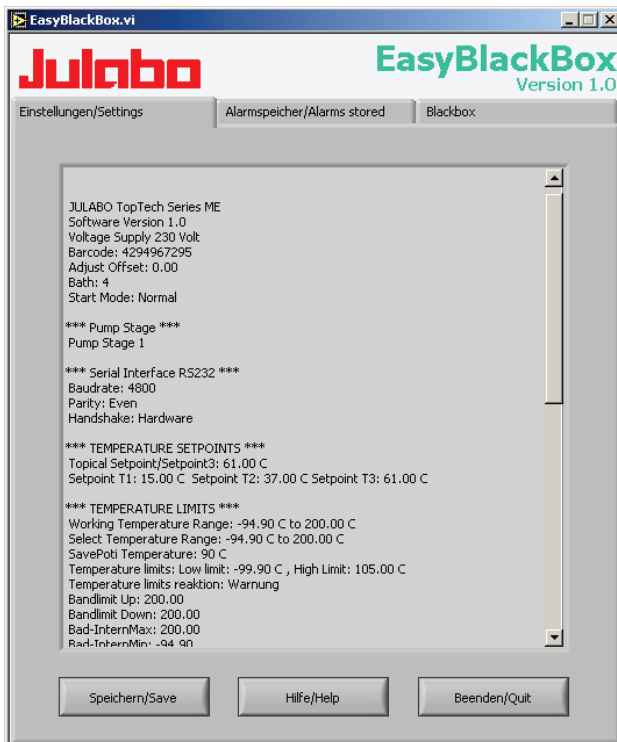

- Data is read out and shown on the monitor divided in the sections >Einstellungen/Settings<, >Alarmspeicher/Alarms stored<, >Blackbox<
- ← see example
- After pressing >Speichern/Save< a text file is compiled. The program proposes a filename - >C:\model description and barcode no.<. Modifications are possible.
- E-mail this file to [service@julabo.com](mailto:service@julabo.com), JULABO's service department. JULABO is thus able to provide rapid support.



## 12. Draining



**Notice:**

Do not drain the bath fluid while it is hot!

Check the temperature of the bath fluid prior to draining (by switching the unit on for a short moment, for example).

Store and dispose the used bath fluid according to the laws for environmental protection.

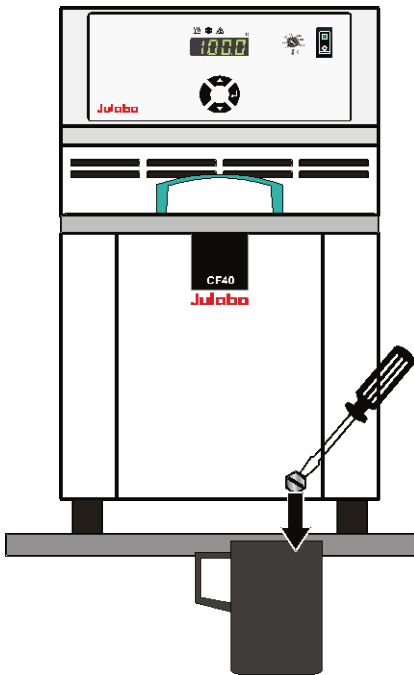

### Draining

- Turn off the unit and disconnect the mains cable from the power source.
- Place the Cryo-compact circulator near the rim of the table. Use a suitable vessel as recipient for the bath liquid
- Unscrew the drain tap and empty the unit completely.
- Tighten the drain tap.

## 13. Cleaning / repairing the unit



**Caution:**

- Always turn off the unit and disconnect the mains cable from the power source before cleaning the unit.
- Prevent humidity from entering into the circulator.
- Service and repair work may be performed only by authorized electricians.

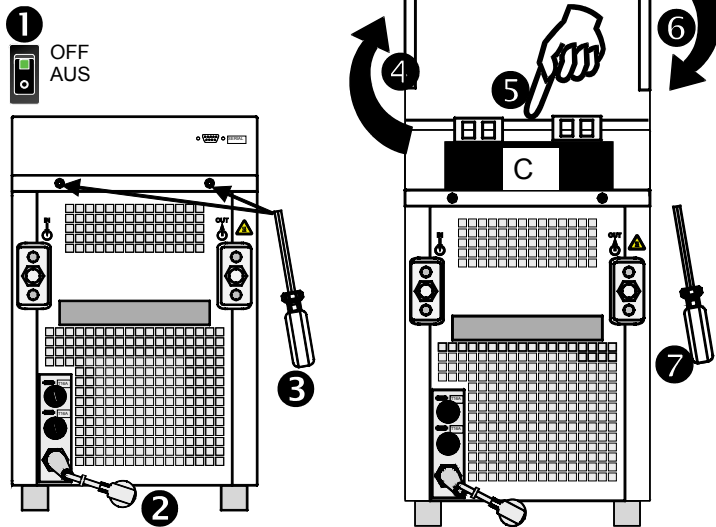

To maintain the full cooling performance, clean the condenser (C) from time to time.

1. Switch off device by pressing the main power switch and
2. disconnect mains cable from power source.
3. Remove 2 screws
4. Lift cover upwards.
5. Remove dirt at condenser by suction cleaning.
6. Close cover and
7. Fix by means of screws.
8. Unit is ready for operation.

### Cleaning:

Clean the outside of the unit using a wet cloth and low surface tension water. The Cryo-Compact Circulator is designed for continuous operation under normal conditions. Periodic maintenance is not required.

The tank should be filled only with a bath fluid recommended by JULABO. To avoid contamination, it is essential to change the bath fluid from time to time.

### Repairs:

Before asking for a service technician or returning a JULABO instrument for repair, please contact an authorized JULABO service station.

When returning the unit:

- Clean the unit in order to avoid any harm to the service personnel
- Attach a short fault description.
- When returning a unit, take care of careful and adequate packing.
- JULABO is not responsible for damages that might occur from insufficient packing.



JULABO reserves the right to carry out technical modifications along with repairs to provide improved performance of a unit.