

Insulation resistance testing

Application Note

Introduction

Insulation resistance testers can be used to determine the integrity of windings or cables in motors, transformers, switchgear, and electrical installations. The test method is determined by the type of equipment being tested and the reason for testing. For instance, when testing electrical cabling or switchgear (low-capacitance equipment) the time-dependent capacitive leakage and absorption leakage currents become insignificant and decrease to zero almost instantly. A steady conductive leakage current flow is reached almost instantly (a minute or less) providing perfect conditions for the spot-reading/short-time resistance test. (For more detailed information on *leakage currents* and *resistance tests* see the following sections: **What Is Insulation Resistance & Leakage Currents** and **Predictive Maintenance Tests**).

On the other hand, when the equipment to be tested is a long run of cable, large motor, or generator (high-capacitance equipment) the time-dependent currents will last for hours. These currents will cause the meter readings to change constantly, making it impossible to obtain an accurate steady reading. This condition can be overcome by using a test that establishes a trend between readings, such as the step voltage or dielectric-absorption test. These tests do not depend on a single reading but on a collection of relative readings. It would be a waste of time to perform these tests on low-capacitance equipment since the time-dependent currents diminish quickly, resulting in all the measurements being the same.

Installation testing

The most important reason for testing insulation is to insure public and personal safety. By performing a high dc voltage test between de-energized current-carrying (hot), grounded, and grounding conductors, you can eliminate the possibility of having a life-threatening short circuit or short to ground. This test is usually performed after the initial installation of the equipment. This process will protect the system against miswired and defective equipment, and it will insure a high quality installation, customer satisfaction, and protect against fire or shock.

Maintenance testing

The second most important reason for insulation testing is to protect and prolong the life of electrical systems and motors. Over the years, electrical systems are exposed to environmental factors such as dirt, grease, temperature, stress, and vibration. These conditions can lead to insulation failure, resulting in loss of production or even fires. Periodic maintenance tests can provide valuable information about the state of deterioration and will help in predicting possible failure of the system. Correcting problems will result not only in a trouble-free system, but will also extend the operating life for a variety of equipment.



Before measuring

In order to obtain meaningful insulation resistance measurements, the electrician should carefully examine the system under test. The best results are achieved when:

1. The system or equipment is taken out of service and disconnected from all other circuits, switches, capacitors, brushes, lightning arrestors, and circuit breakers. Make sure that the measurements are not affected by leakage current through switches and overcurrent protective devices.
2. The temperature of the conductor is above the dew point of the ambient air. When this is not the case, a moisture coating will form on the insulation surface, and, in some cases will be absorbed by the material.
3. The surface of the conductor is free of carbon and other foreign matter that can become conductive in humid conditions.
4. Applied voltage is not too high. When testing low-voltage systems; too much voltage can overstress or damage insulation.
5. The system under test has been completely discharged to the ground. The grounding discharge time should be about five times the testing charge time.
6. The effect of temperature is considered. Since insulation resistance is inversely proportional to insulation tempera-

ture (resistance goes down as temperature goes up), the recorded readings are altered by changes in the temperature of the insulating material. It is recommended that tests be performed at a standard conductor temperature of 20 °C (68 °F). As a rule of thumb, when comparing readings to 20 °C base temperature, double the resistance for every 10 °C (18 °F) above 20 °C or halve the resistance for every 10 °C below 20 °C in temperature. For example, a one-megohm resistance at 40 °C (104 °F) will translate to four-megohm resistance at 20 °C (68 °F). To measure the conductor temperature, use a non-contact infrared thermometer such as the Fluke 65.

Work safely

Safety is everyone's responsibility, but ultimately it is in your hands. No tool by itself can guarantee your safety. It is the combination of the instrument and safe work practices that gives you maximum protection. Here are a few safety tips you should follow:

- Work on de-energized circuits whenever possible. Use proper lock-out/tag-out procedures. If these procedures are not in place or not enforced, assume the circuit is live.
- On live circuits, use protective gear:
 - Use insulated tools
 - Wear flame resistant clothing, safety glasses, and insulation gloves
 - Remove watches or other jewelry
 - Stand on an insulation mat
- When making voltage measurements on live circuits:
 - Hook on the ground clip first, then make contact with the hot lead. Remove the hot lead first and the ground lead last.
- Hang or rest the meter if possible. Try to avoid holding it in your hands to minimize personal exposure to the effects of transients.
- Use the three-point test method, especially when checking to see if a circuit is dead. First, test a known live circuit. Second, test the target circuit. Third, test a live circuit again. This verifies that your meter worked properly before and after the measurement.
- Use the old electricians' trick of keeping one hand in your pocket. This lessens the chance of a closed circuit across your chest and through your heart.
- When performing insulation and resistance tests:
 - Never connect the insulation tester to energized conductors or energized equipment and always follow the manufacturer's recommendations.
- Shut down the equipment to be tested by opening fuses, switches, and circuit breakers.
- Disconnect the branch circuit conductors, grounded conductors, grounding conductors, and all other equipment from the unit under test.
- Discharge conductor capacitance, both before and after the test. Some instruments may have automatic discharge functions.
- Check for any leakage current through fuses, switches, and breakers on de-energized circuits. Leakage current can cause inconsistent and incorrect readings.
- Don't use an insulation tester in a dangerous or explosive atmosphere since the instrument can generate arcing in damaged insulation.
- Use insulated rubber gloves when connecting the test leads.

What are insulation resistance and leakage currents?

During the testing procedure, the high dc voltage generated by pressing the test button will cause a small (micro-amps) current flow through the conductor and the insulation. The amount of current depends on the amount of voltage applied, the system's capacitance, the total resistance, and the temperature of the material. For a fixed voltage, the higher the current, the lower the resistance ($E=IR$, $R=E/I$). The total resistance is the sum of the internal resistance of the conductor (small value) plus the insulation resistance in $M\Omega$ s.

The value of insulation resistance read on the meter will be a function of following three independent sub-currents.

Conductive leakage current (I_L)

Conductive current is a small (micro-amp) amount of current that normally flows through insulation, between conductors or from a conductor to ground. This current increases as insulation deteriorates and becomes predominant after the absorption current (see Figure 1) vanishes. Because it is fairly steady and time independent, this is the most important current for measuring insulation resistance.

Capacitive charging leakage current (I_C)

When two or more conductors are run together in a raceway, they act as a capacitor. Due to this capacitive effect, a leakage current flows through conductor insulation. This current lasts only for a few seconds as the dc voltage is applied and drops out after the insulation has been charged to its full test voltage. In low-capacitance equipment, the capacitive current is higher than conductive leakage current, but usually disappears by the time we start recording the data. Because of this, it is important to let the reading "settle out" before recording it. On the other hand, when testing high capacitance equipment the capacitive charging leakage current can last for a very long time before settling out.

Polarization absorption leakage current (I_A)

Absorption current is caused by the polarization of molecules within dielectric material. In low-capacitance equipment, the current is high for the first few seconds and decreases slowly to nearly zero. When dealing with high capacitance equipment or wet and contaminated insulation, there will be no decrease in the absorption current for a long time.

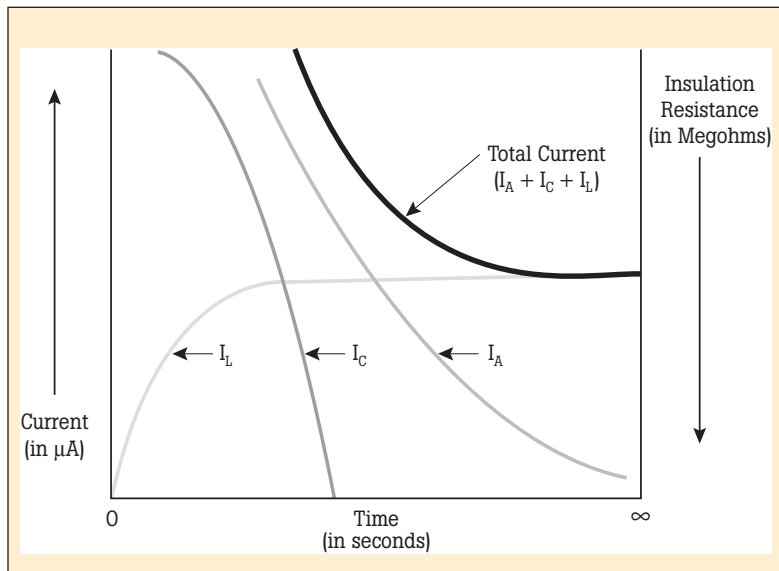

Figure 1. Current components

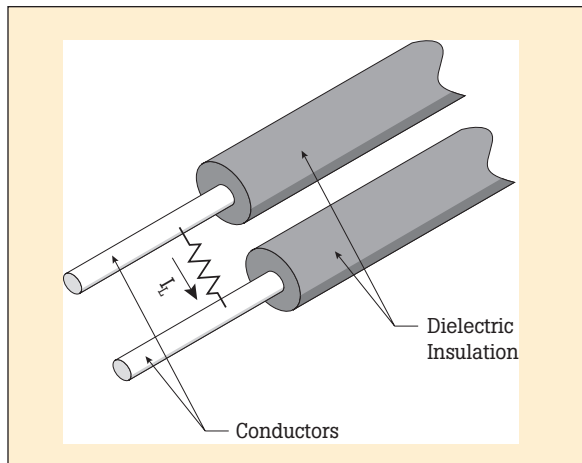

Figure 2. Conductive leakage current (I_L)

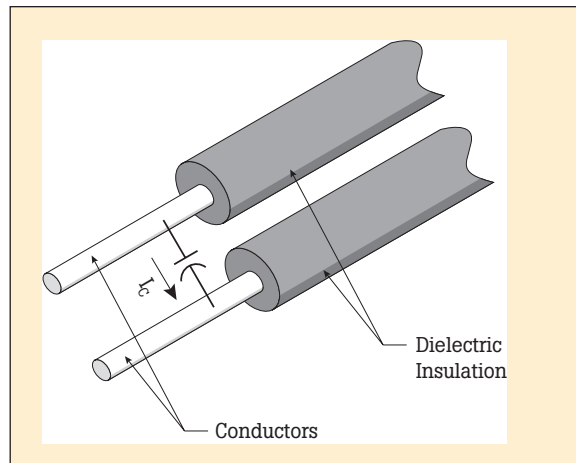

Figure 3. Capacitive charging leakage current (I_C)

Applications

Installation test

Proof testing

Electricians and engineers perform proof tests to insure proper installation and integrity of conductors. The proof test is a simple, quick test used to indicate the instantaneous condition of insulation. It provides no diagnostic data and the test voltages used are much higher than the voltages used in predictive maintenance tests. The proof test is sometimes called GO/NO GO TEST because it tests cable systems for maintenance errors, incorrect installation, serious degradation, or contamination. The installation is declared acceptable if no breakdown occurs during testing.

Choosing the test voltage

A proof test can be performed on equipment of any capacitance. It is performed with a single voltage, usually between 500 and 5000 V, for about one minute. It is common to stress the insulation above normal working voltages in order to detect subtle weaknesses in the insulation. For new equipment, the test should be done at about 60% to 80% of the

manufacturer's factory test voltage (higher than the rated voltage and is available from the cable manufacturer). If you don't know the factory test voltage, test using a voltage about twice the cable's rated voltage plus 1000 volts. Rated voltage is the maximum amount of voltage that the conductor can be exposed to for a prolonged amount of time, usually printed on the conductor. For single-phase, two-phase, or three-phase systems, the cable is rated phase-to-phase.

This previously mentioned method should only be used for testing small and new apparatus because of its ability to withstand higher stress voltages. For larger or older equipment or wire use dc test voltages (see table 3).

Common proof dc test voltages (not the manufacturer's test voltages) used for testing rotating equipment are shown in Table 1.

Rotating Equipment DC Test Voltages	Formula Used
Factory AC Test, VAC (only for reference)	$2 \times (\text{VAC Nameplate Rating}) + 1,000$
Maximum DC Installation Test, VDC	$1.28 \times (\text{Factory AC Test})$
Maximum DC After Service Test, VDC	$0.96 \times (\text{Factory AC Test})$

Table 1. Proof test voltage equations for rotating machines

Proof test procedure

To conduct an installation proof test, use the following procedure:

- Use a multimeter or the voltage measurement function on the MegOhmMeter to make sure there is no power applied to the tested circuit.
- Select the appropriate voltage level.
- Plug one end of the black test lead to the common terminal on the meter and touch the test probe to a ground (earth) or another conductor. Sometimes it is helpful to ground all conductors that are not part of the test. Alligator clips can make measurements easier and more accurate.
- Plug one end of the red test lead to the volt/ohm terminal on the meter and connect the test probe to the conductor to be tested.
- Press the test button to apply the desired voltage and

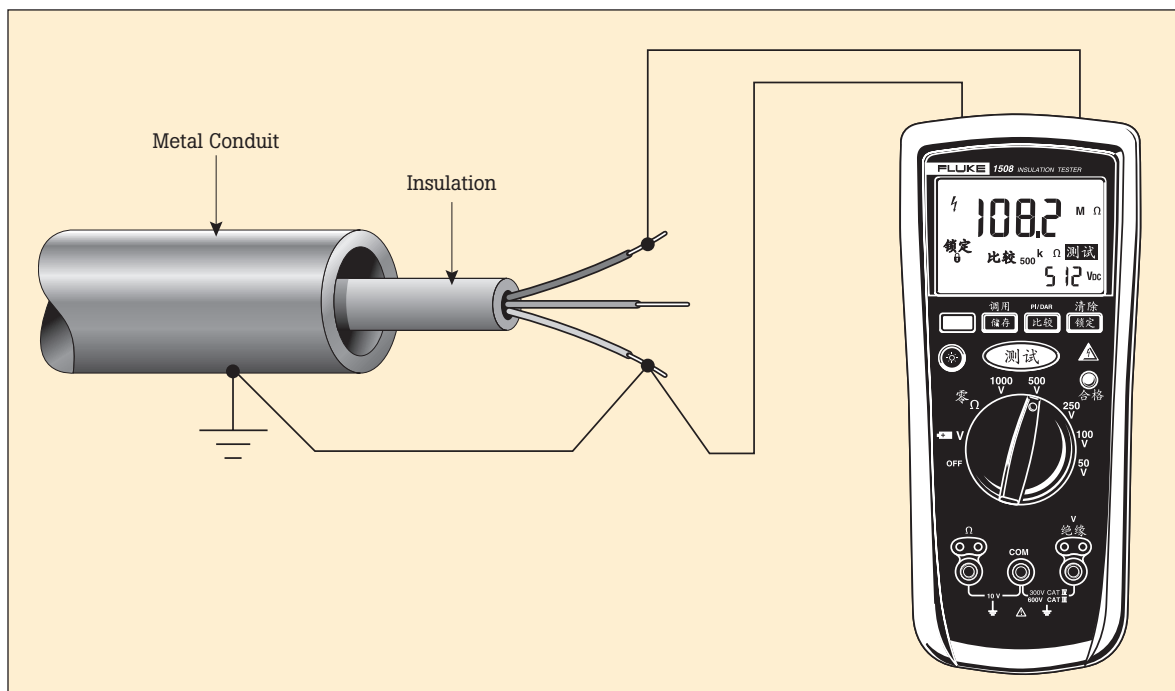

Figure 4. Conductor under test

read the resistance displayed on the meter. It could take a few seconds for the reading to settle. The higher the resistance is the better.

- Test each conductor against ground and against all the other conductors present in the conduit. Keep a dated record of the measured values in a safe place.
- If some of the conductors fail the test, identify the problem or re-pull the conductors. Moisture, water, or dirt can create low resistance readings.

Predictive maintenance tests

Maintenance tests can provide important information about the present and future state of conductors, generators, transformers, and motors. The key to effective maintenance testing is good data collection. Examining the collected data will aid in scheduling diagnostic and repair work, which will reduce downtime from unexpected failures. The following are the most commonly applied dc test voltages and maintenance tests performed:

Equipment AC Rating (Volts)	DC Test Voltage (Volts)
0 – 100	100 – 250
440 – 560	500 – 1,000
2,300	1,000 or higher
4,100 and above	1,000 or higher

Table 2. Maintenance test voltages versus equipment ratings

Spot-reading/short-time resistance test

During the short-time test, the MegOhmMeter is connected directly across the equipment being tested and a test voltage is applied for about 60 seconds. In order to reach a stable insulation reading in about one minute, the test should only be performed on low-capacitance equipment. The basic connection procedure is the same as for a proof test and the voltage applied is calculated from the dc test voltage formulas. When testing good equipment, you

should notice a steady increase in insulation resistance due to decrease in capacitive and absorption currents. Because temperature and humidity can affect the readings, the measurements should preferably be made above the dew point at standard temperature, about 20 °C/68 °F.

For equipment rated at or below 1000 volts, the insulation reading should be of a value of 1 MΩ or greater. For equipment rated above 1000 volts, the expected resistance should increase to one megohm per 1000 volts applied. Usually, the measured insulation resistance will be a bit less than the values recorded previously, resulting in a gradual downward trend as

shown in Figure 6. The downward slope is a normal sign of insulation aging. A sharp downward slope would indicate an insulation failure or a warning of troubles ahead.

DC Test Voltages	Formula Used
For phase-to-phase voltage rating	$DCt = 0.8165 \times E_{p-p}$
For phase-to-ground voltage rating	$DCt = 1.414 \times E_{p-n}$

Table 3. DC test voltage equations

DCt - dc test voltage related to the maximum insulation stress during normal ac operation

E_{p-p} - Phase-to-phase voltage rating

E_{p-n} - Phase-to-ground voltage rating

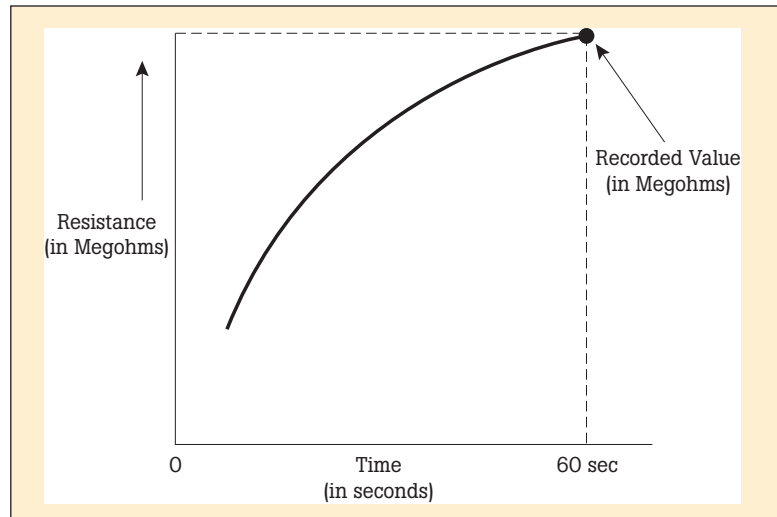

Figure 5. Insulation resistance test

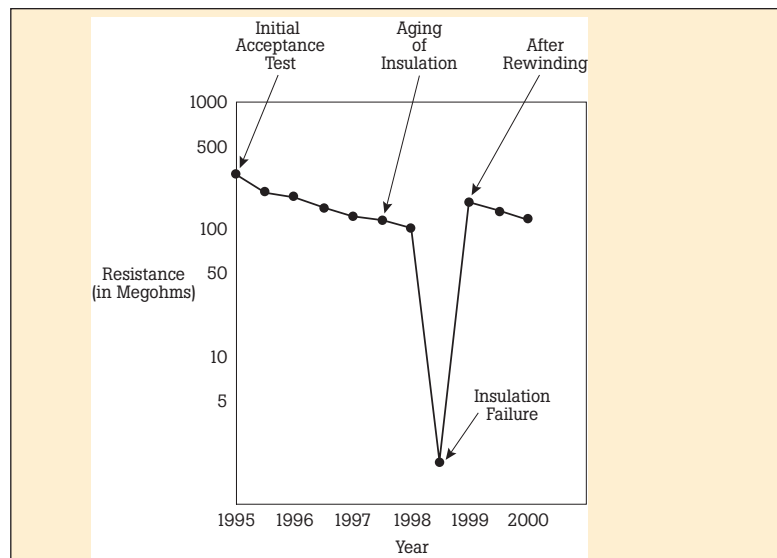

Figure 6. Insulation resistance over a period of time

Step voltage test

The step voltage test involves resistance testing at various voltage settings. In this test, you apply each test voltage for the same period of time (usually 60 seconds), graphing the recorded insulation resistance. By applying increasing voltages in steps, the insulation is exposed to increased electrical stress that can reveal information about flaws in the insulation such as pinholes, physical damage, or brittleness. Good insulation should withstand an increase in over-voltage stress and its resistance should remain approximately the same during testing with different voltage levels. On the other hand, especially at higher voltage levels, deteriorated, cracked or contaminated insulation will experience an increased current flow, resulting in a decrease in insulation resistance. This test is independent of insulation material, equipment capacitance, and temperature effect. Because it takes a longer time to run, it should be performed only after an insulation spot test has been inconclusive. A spot test deals with absolute resistance change (single reading) with respect to time, while the step voltage test looks for trends in resistance, with respect to varying test voltages.

Dielectric-absorption/time-resistance test

The time resistance test is independent of equipment size and temperature. It compares the absorption characteristics of contaminated insulation with the absorption characteristics of good insulation. The test voltage is applied over a 10 minute period, with the data recorded every 10 seconds for the first minute and then every minute thereafter. The interpretation of the slope of the plotted graph will determine the condition of the insulation. A continuous increase in graphed resistance indicates good insulation. A flat or downward curve indicates cracked or contaminated insulation.

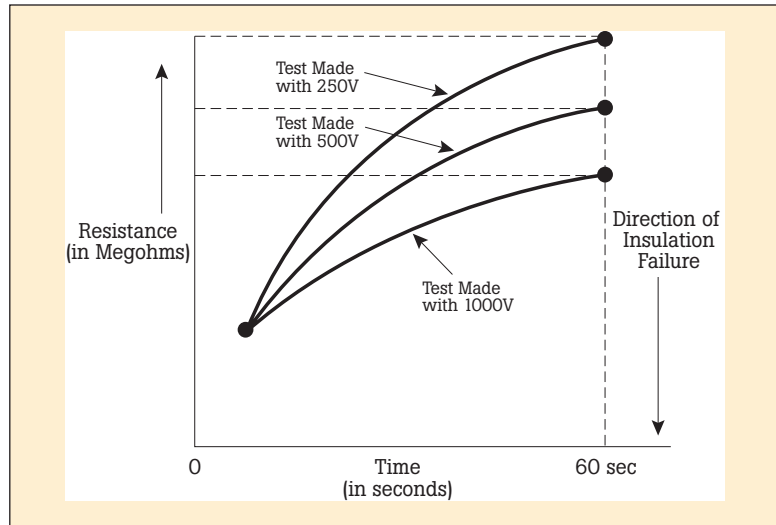

Figure 7. Step voltage test

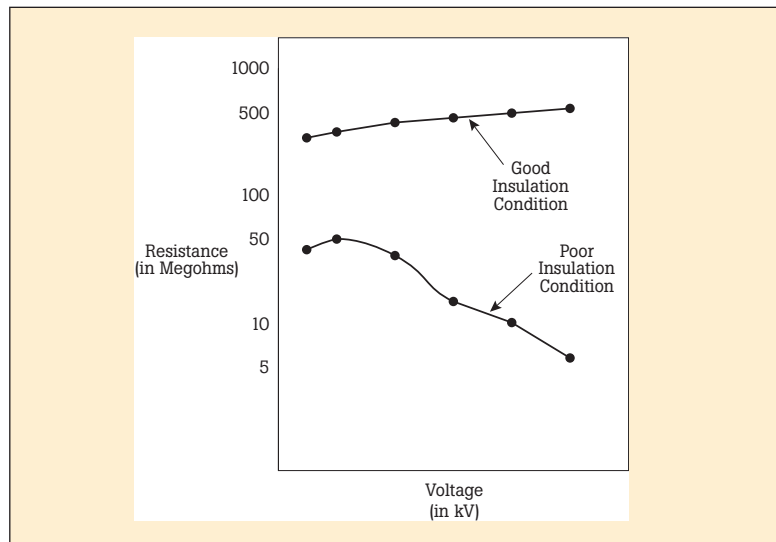

Figure 8. Good and poor test curves

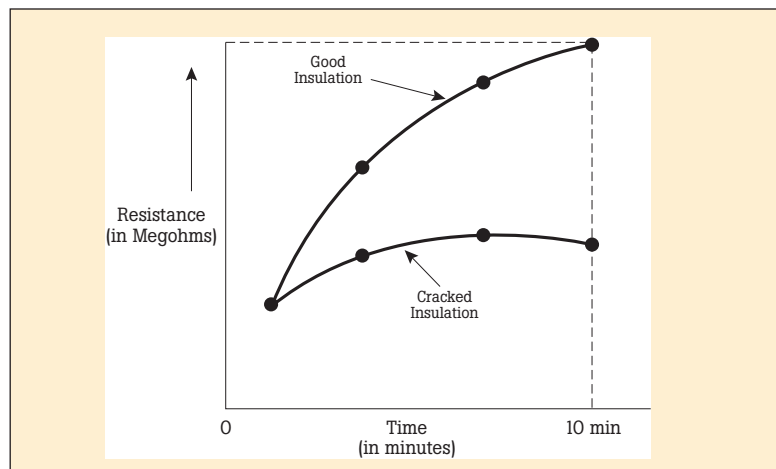

Figure 9. Dielectric absorption test for good and contaminated curves

Another method for determining the quality of insulation is to use the polarization index (PI) test. It is particularly valuable for uncovering moisture and oil ingress that have a flattening effect on the PI curve, causing leakage current and eventually shorted windings. The polarization index is the ratio of two time-resistance readings: one is taken after 1 minute and the other is taken after 10 minutes. With good insulation, the insulation resistance will start low and get higher as the capacitive leakage current and absorption current get smaller. Results are obtained by dividing the 10 minute test value by the one-minute test value. A low polarization index usually indicates problems with the insulation. When test time is constrained, a shortcut to the polarization index test is the dielectric absorption ratio (60/30) second test.

Testing connections in generators, transformers, motors, and wiring

To test the insulation resistance in generators, transformers, motors, and wiring installations, we can employ any of the previously mentioned predictive maintenance tests. Whether we choose the spot-reading, step voltage, or time-resistance tests depends on the reason for testing and the validity of the data obtained. When testing generators, motors, or transformers each winding/phase should be tested in sequence and separately while all the other windings are grounded. In this way, the insulation between phases is also tested.

Temperature correction for testing rotating machines

For testing armature and field winding insulation resistance at various temperatures, the IEEE recommends the following insulation resistance formula.

$$R_m = K_t \times (kV + 1)$$

Table 6. Insulation resistance equation for ac and dc rotating machinery

Insulation Resistance Condition	60/30 Second Ratio	10/1 Minute Ratio (Polarization Index)
Dangerous	0 - 1.0	0 - 1
Poor	1.0 - 1.3	1 - 2
Good	1.3 - 1.6	2 - 4
Excellent	1.6 and above	4 and above

Table 4. Approximate dielectric absorption ratios

	Proof Test	Spot- Test Reading	Step Test Voltage	Dielectric-Absorption Test	Polarization Index Test
Single reading	•	•			
High test voltage	•				
Performed periodically		•	•	•	•
Various test voltages			•		
Timed test intervals				•	•
Diagnostic information		•	•	•	•

Table 5. Various insulation tests

- Rm - Minimum insulation resistance corrected to 40 °C (104 °F) in MΩ
- Kt - Insulation resistance temperature coefficient at winding temperature, obtained from Figure 10
- kV - Rated machine terminal to terminal voltage in kilovolts

For a three phase system tested with the other two phases grounded, the resistance recorded for each phase should be divided by two. Then, the resulting value can be compared with the recommended minimum insulation resistance (Rm).

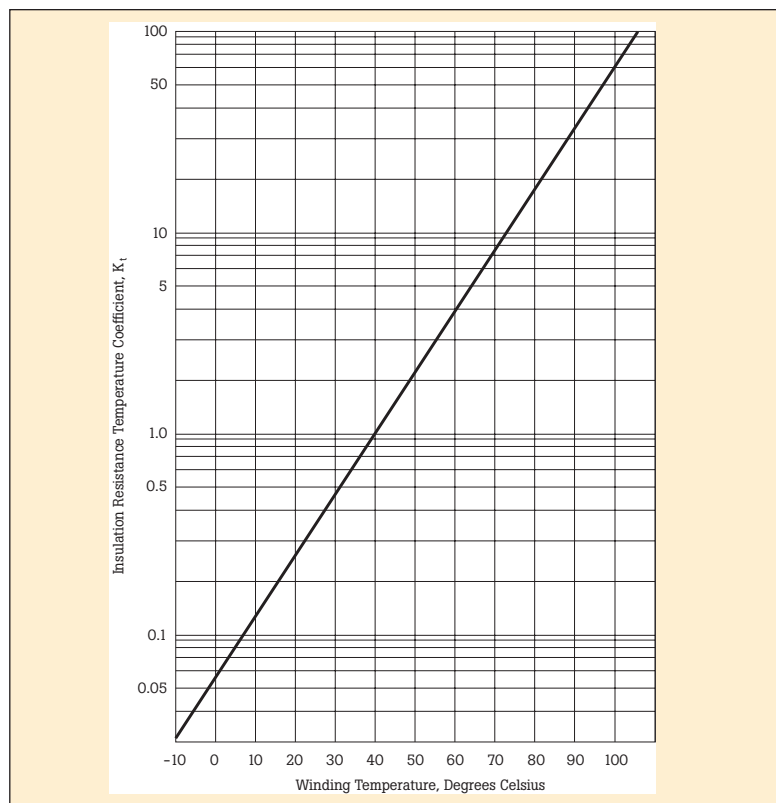

Figure 10. Approximate temperature coefficient for rotating machines

Testing generators and motors

When testing the resistance of the stator coils make sure the stator winding and phases are disconnected. Measure the insulation resistance between windings and windings to ground. Also, when dc generators or motors are being tested the brushes should be raised so the coils can be tested separately from the armature. The following table lists recommended minimum resistance readings for various motor voltage ratings.

Motor Nameplate Voltage Rating	Minimum Acceptable Resistance
0-208	100,000 Ω
208-240	200,000 Ω
240-600	300,000 Ω
600-1000	1 MΩ
1000-2400	2 MΩ
2400-5000	3 MΩ

Table 7. Recommended minimum resistance at 40°C (104°F)

Testing transformers

When testing single-phase transformers, test winding to winding, winding to ground, or test one winding at a time with all others grounded. For three-phase transformers, substitute E with E_{p-p} (for delta transformers) or E_{p-n} (for wye transformers) and kVA with kVA_{3Ø} rating of the winding under test.

For determining minimum insulation resistance use the following formula.

Transformer Type	Formula Used
Single phase	$R = C \times E + \sqrt{kVA}$
Three phase wye	$R = C \times E_{p-n} + \sqrt{kVA}$
Three phase delta	$R = C \times E_{p-p} + \sqrt{kVA}$

Table 8. Transformers insulation resistance equations

- R - One minute 500 volt dc minimum insulation resistance in megohms
- C - Constant for 20 °C (68 °F) measurements (see below)
- E - Winding voltage rating.
- KVA - Rated capacity of winding under test. For three phase units $kVA_{3Ø} = \sqrt{3} \times kVA_{1Ø}$

Transformer Type	60-Hertz
Tanked oil-filled type	1.5
Untanked oil-filled type	30.0
Dry or compound-filled type	30.0

Table 9. Constant C values at 20°C (68°)

Testing wiring and cable installations

When testing wires or cables, they should be disconnected from panels and machinery to keep them isolated. The wires and cables should be tested against each other and against ground (see Figure 4 on page 4). The Insulated Power Cable Engineers Association (IPCEA) provides the following formula that suggests minimum insulation resistance values.

$$R = K \times \text{Log}_{10} (D/d)$$

Table 10. Cable insulation resistance

- R - MΩs per 1000 feet (305 meters) of cable. Based on dc test potential of 500 volts, applied for one minute at 15.6 °C (60 °F) temperature)
- K - Insulation material constant. (For example: Impregnated Paper-2640, Varnished Cambric-2460, Thermoplastic Polyethylene-50000, Composite Polyethylene-30000)
- D - Outside diameter of conductor insulation for single conductor wire and cable $D = d + 2c + 2b$ diameter of single conductor cable
- d - Diameter of conductor
- c - Thickness of conductor insulation
- b - Thickness of jacket insulation

For example, one thousand feet of number 6 A.W.G. Heat Resistant Natural Rubber insulation type stranded conductor with 0.125 insulation thickness will have $K = 10,560$ and $\text{Log}_{10} (D/d) = 0.373$ inches. According to the formula ($R = K \times \text{Log}_{10} (D/d)$), $R = 10,560 \times 0.373 = 3,939$ MΩ per 1000 feet) the expected minimum insulation resistance for single conductor per thousand feet at temperature of 60 °F will be 3,939 MΩ.

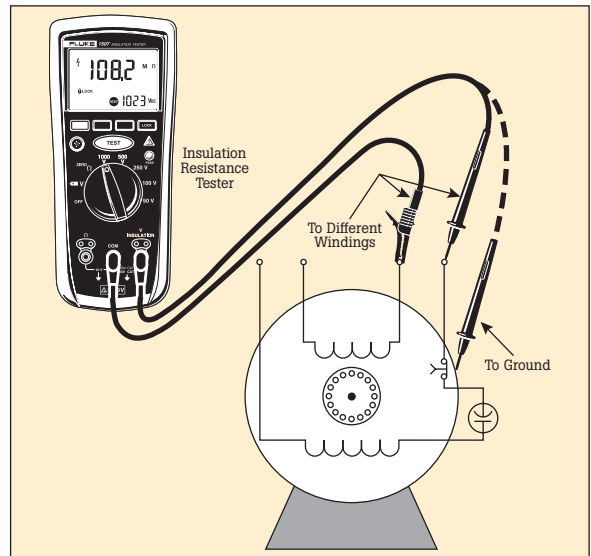

Figure 11. Testing the insulation resistance of a motor

Fluke. Keeping your world up and running.®



205 Westwood Ave
Long Branch, NJ 07740
1-877-742-TEST (8378)
Fax: (732) 222-7088
salesteam@Tequipment.NET