

# 800Plus

## Universal Digital Counter

### Series 2

# INSTRUCTION MANUAL

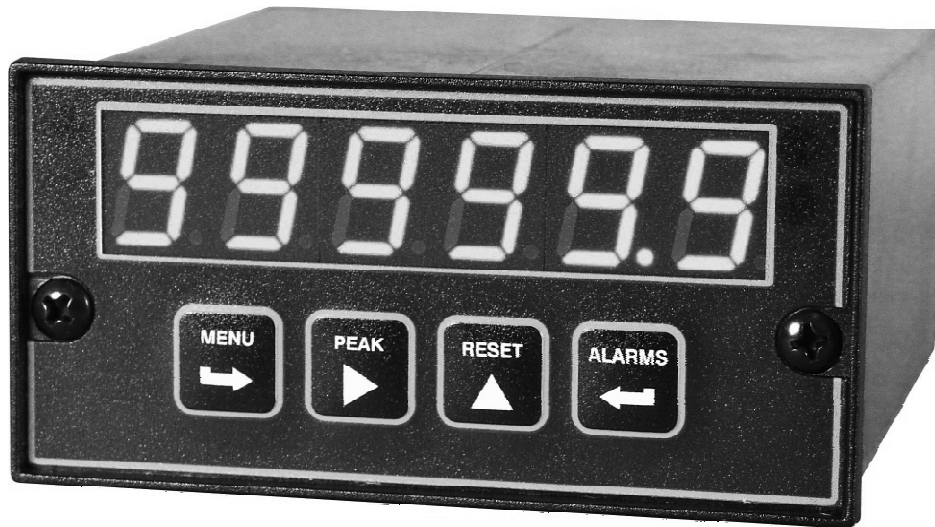

**Now with Ethernet**



# 1. ORDERING GUIDE

Configure a model number in this format: **850200FR**

- |   |   |
|---|---|
| <input type="checkbox"/> <b>8....800<sup>Plus</sup></b> Counter/timer/serial input meter<br>Includes screw terminal connectors.   | <b>Extended counter</b><br>Above plus rate and total simultaneously, custom curve linearization, arithmetic functions (A*B, A/B, A+B, A-B, A/B-1), phase angle, duty cycle, up/down counting, batch control.  |
| <input type="checkbox"/> <b>Processors &amp; Display Color</b><br>5 ..... Basic, Green LED<br>6 ..... Basic, Red LED<br>7 ..... Extended, green LED<br>8 ..... Extended, red LED<br><br><b>Note:</b> "Extended" adds custom curve linearization and other capabilities as indicated.  | <b>Process Receiver &amp; Totalizer Signal</b><br><b>VF1</b> ..... 4-20mA<br><b>VF2</b> ..... 0-1mA<br><b>VF3</b> ..... 0-10V   |
| <input type="checkbox"/> <b>Power</b><br>0 ..... 85-264 Vac, 90-300 Vdc<br>1 ..... 10-48 Vdc, 12-30 Vac   | <b>Basic counter</b><br>Rate, square root of rate (use with differential pressure or target type flow meters), process signal totalizer.  |
| <input type="checkbox"/> <b>Setpoint Output</b><br>0 ..... None<br>1 ..... Two 8A contact relays<br>2 ..... Two 120 mA solid state relays<br>3 ..... Four 8A contact relays<br>4 ..... Four 120 mA solid state relays   | <b>Extended counter</b><br>Above plus custom curve linearization, batch control, time based on rate.  |
| <input type="checkbox"/> <b>Analog Output</b><br>0 ..... None<br>1 ..... Single 4-20 mA, 0-10 V, -10 to +10 V<br>2 ..... Dual 4-20 mA, 0-20 mA, 0-10 V  | <b>Quadrature Input</b><br><b>QD</b> ..... Position, length, rate   |
| <input type="checkbox"/> <b>Digital Interface</b><br>0 ..... None<br>1 ..... RS232<br>2 ..... RS485<br>4 ..... RS485-Modbus<br>5 ..... USB<br>6 ..... USB-to-RS485 converter<br>7 ..... Ethernet<br>8 ..... Ethernet-to-RS485 converter   | <b>Basic counter</b><br>Position or length from encoders. Accepts differential or single-ended inputs: 1x, 2x or 4x, plus zero index.<br><br><b>Extended counter</b><br>Above plus bidirectional rate (rate and position are not simultaneous).   |
| <input type="checkbox"/> <b>Signal Conditioner</b><br><b>None</b> ..... 6-Digit Remote Display<br><b>FR</b> ..... Dual Channel Pulse or AC Input<br><br><b>Basic counter</b><br>Frequency (2 channels), rate (2 channels), total (up or down, 2 channels), period (2 channels), stopwatch, time interval, square root of rate, or 6-digit remote display. | <hr/> <b>Options</b><br><b>EB</b> ..... Extra bright red LED display<br><b>BL</b> ..... Blank lens, no button pads<br><br><b>Accessories</b><br><b>CBL01</b> ..... RJ11-to-DB9 RS232 cable<br>Connects meter to PC com port<br><b>CBL02</b> ..... USB-to-DB9 adapter for CBL01<br><b>CBL05</b> ..... USB cable to PC USB port |

## 2. TABLE OF CONTENTS

1.	ORDERING GUIDE .....	2
2.	TABLE OF CONTENTS .....	3
3.	PRODUCT INTRODUCTION .....	4
4.	RECEIVING & UNPACKING .....	5
5.	SAFETY CONSIDERATIONS .....	5
6.	CONNECTOR WIRING INFORMATION .....	6
7.	MECHANICAL ASSEMBLY .....	8
8.	FRONT PANEL SETUP KEYS .....	10
9.	ENABLING & LOCKING OUT MENU ITEMS .....	12
10.	DUAL CHANNEL PULSE OR AC INPUT SIGNAL CONDITIONER (FR) .....	13
11.	PROCESS RECEIVER & TOTALIZER SIGNAL CONDITIONER (VF) .....	31
12.	QUADRATURE SIGNAL CONDITIONER (QD) .....	38
13.	SERIAL INPUT METER / REMOTE DISPLAY (NO SIGNAL CONDITIONER) .....	54
14.	DUAL & QUAD RELAY OUTPUT OPTIONS .....	56
15.	SINGLE & DUAL ANALOG OUTPUT OPTIONS .....	59
16.	SERIAL COMMUNICATION OPTIONS .....	61
17.	EXCITATION OUTPUT & POWER SUPPLY .....	66
18.	INSTRUMENT SETUP VIA PC .....	67
19.	CUSTOM CURVE LINEARIZATION .....	70
20.	METER CALIBRATION .....	71
21.	SPECIFICATIONS .....	72
22.	GLOSSARY OF TERMS .....	75
23.	WARRANTY .....	80

### 3. PRODUCT INTRODUCTION

**Our counters** are a versatile, cost effective solution to a wide range of monitoring and control applications including frequency, rate, total, period, time, phase, position, and flow. Setup can be via front panel pushbuttons or a PC. Selective lockout of front panel keys protects against accidental or unauthorized setup changes and simplifies meter use.

**A dual-channel pulse or AC input signal conditioner board** accommodates a wide range of applications including rate/frequency, totalizing, timing, phase angle, power factor, and duty cycle. Frequency and rate are determined by taking the inverse of period. Fast read rate is ideal for peak or valley capture and allows quick response for control applications. Adaptive digital filtering provides stable readings and control outputs while responding rapidly to actual changes of the signal. A high stability quartz crystal and digital calibration assure accurate rate and analog measurements.

**A process receiver & totalizer signal conditioner board** accepts 4-20 mA, 0-1 mA or 0-10V analog signals for display of rate or position. Square root extraction is selectable for use with differential pressure flow transducers.

**A quadrature signal conditioner board** provides accurate display of position, angle, or rate.

**Ethernet USB, RS232, or RS485** (2-wire half-duplex or 4-wire full-duplex) serial communications options are available with the Modbus protocol or a simpler custom ASCII protocol. Modbus operation includes RTU or ASCII modes, up to 247 digital addresses, and up to 32 devices per RS485 line without a repeater. Ethernet-to-RS485 and USB-to-RS485 converter boards allow a meter to be interfaced to a PC and to multiple meters on an RS485 network

**Meter programming** can be via the meter's front panel or a PC running Windows based Instrument Setup Software. A serial interface option is required.

**A standard switching power supply** allows the meters to be powered worldwide from 85 to 264 Vac. An optional power supply operates from batteries or low voltage sources, such as 12-32 Vac.

**A built-in isolated excitation supply** with jumper-selectable 5, 10 or 24 Vdc output levels is standard and can eliminate the need for an external sensor power supply.

**A dual or quad relay board** is optional for alarm or control. The relays can be Form C 8A mechanical relays or 2 or 4 Form A 120 mA solid state relays. The setpoints can be latching or non-latching, be energized above or below the setpoint, or operate in a fail-safe mode.

**A single or dual isolated analog output board** is optional. With dual outputs, one of the outputs can be assigned to the reading (such a rate), while other reading is assigned a non-displayed item (such as total). The outputs can be 0-20 mA, 4-20 mA, 0-10V, or -10V to +10V.

**Operation as a 6-digit serial input meter** is achieved with a serial interface and no signal conditioner board, allowing the unit to serve as the remote display of a computer, PLC or other meter. With an optional dual or quad relay board, the unit can provide local alarm or On/Off control. With an optional analog output board, it can also serve as a local isolated transmitter.

**The meter case** meets the 1/8 DIN size standard and is sealed to NEMA-4X (IP65) when panel mounted. Mounting is from the front of the panel and requires less than 110 mm behind the panel. All wiring is via removable plugs conforming to IEC950 safety standards. All output options are isolated from meter and power grounds to 250 Vac.

## 4. RECEIVING & UNPACKING

Your meter was carefully tested and inspected prior to shipment. Should the meter be damaged in shipment, notify the freight carrier immediately. In the event the meter is not configured as ordered or the unit is inoperable, return it to the place of purchase for repair or replacement. Please include a detailed description of the problem.

## 5. SAFETY CONSIDERATIONS



**Warning:** Use of this equipment in a manner other than specified may impair the protection of the device and subject the user to a hazard. Visually inspect the unit for signs of damage. If the unit is damaged, do not attempt to operate.

### Caution:

- The unit must be connected to a Disconnect switch or a branch-circuit breaker, which must be in a suitable location
- This unit must be powered with AC (mains) from 85-264 Vac with the high voltage power supply option, or 10-48 Vdc (12-32 Vac) with the low voltage power supply option. Verify that the proper power option is installed for the power to be used. This meter has no AC (mains) switch. It will be in operation as soon as power is connected.
- The 85-264 Vac mains connector (P1 Pins 1-3) is colored Green to differentiate it from other input and output connectors. The 12-32 Vac (10-48 Vdc) mains connector is colored Black.
- Do not make signal wiring changes or connections when power is applied to the instrument. Make signal connections before power is applied. If reconnection is required, disconnect the AC (mains) power before such wiring is attempted.
- To prevent electrical or fire hazard, do not expose the instrument to excessive moisture.
- Do not operate the instrument in the presence of flammable gases or fumes; such an environment constitutes a definite safety hazard. This meter is designed to be mounted in a metal panel or a bench or wall mount style case. The spacing around the meter and the ventilation must be sufficient to maintain the ambient temperature at less than 55°C.
- Verify the panel cutout dimensions, and mount according to instructions.

### Symbols used



Caution (refer to accompanying documents)



Caution, risk of electric shock.



Equipment protected throughout by double insulation or reinforced insulation.



Earth (ground) terminal.



Both direct and alternating current.

### Operating environment:

The meter is Class II (double insulated) equipment designed for use in Pollution degree 2.

## 6. CONNECTOR WIRING INFORMATION

### CONNECTORS

Connectors for signal and power are U/L rated screw-clamp terminal blocks that plug into mating jacks on the circuit board. Communication connectors are a single RJ11 plug for RS232, a type B jack for USB, dual RJ11 or RJ45 plugs for RS485, or RJ45 for Ethernet. The functions of controls inputs 1 and 2 are menu selectable. Control input 2 can be converted to a +5V, 50 mA power output. Please see page 66.

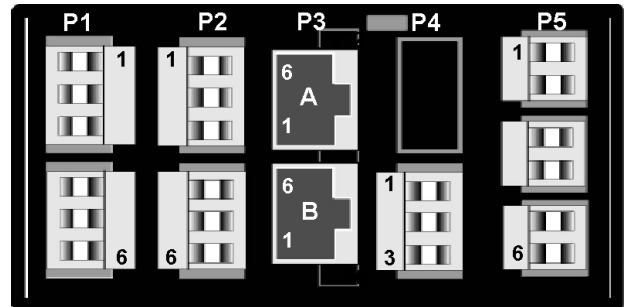

### P1 - POWER AND DIGITAL CONTROLS

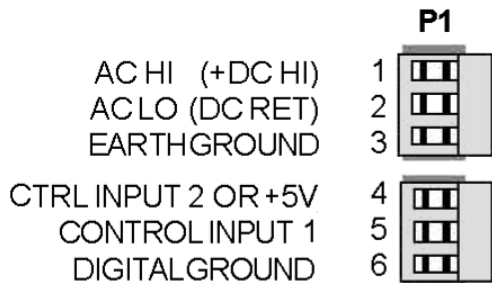

**Caution:** P1 pins 4, 5, and 6 may have hazardous voltages present.

### P5 - SIGNAL INPUT

#### VF -- VOLTAGE-TO-FREQUENCY CONVERTER

##### 4-WIRE PROCESS TRANSMITTER

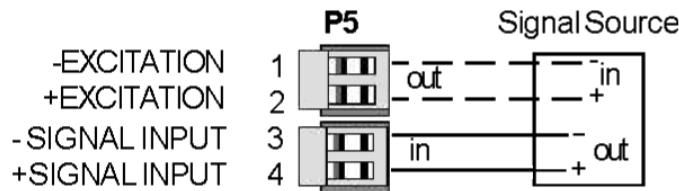

##### 2-WIRE PROCESS TRANSMITTER

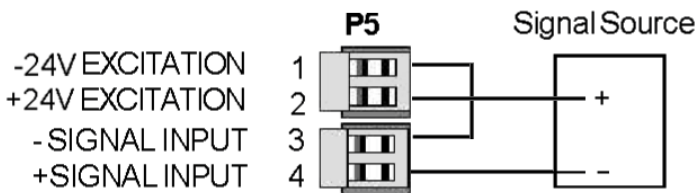

### FR -- DUAL CHANNEL PULSE INPUT

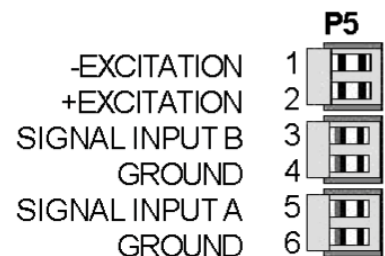

Ground pins 4 & 6 are internally connected.

### QD -- QUADRATURE INPUT (DIFFERENTIAL)

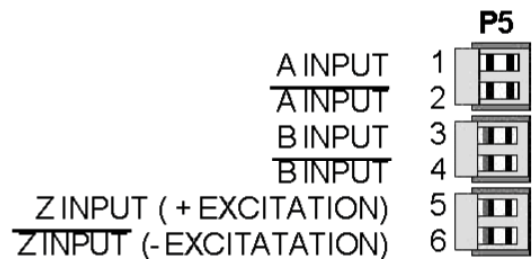

Z input or excitation is jumper selectable.

### QD -- QUADRATURE INPUT (SINGLE-ENDED)

Select 5V or 10V excitation to match encoder.

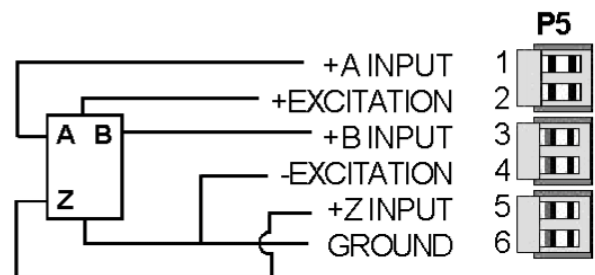

## P2 - SETPOINT CONTROLLER

### DUAL MECHANICAL RELAY OUTPUTS



### QUAD MECHANICAL RELAY OUTPUTS

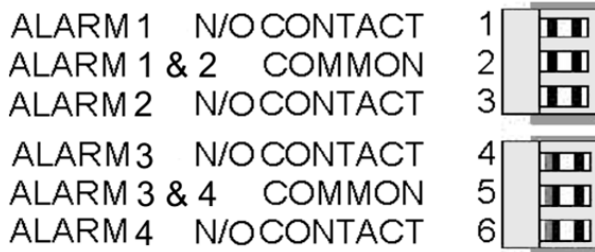

## P3 - SERIAL COMMUNICATIONS

### RS232 INTERFACE

Computer

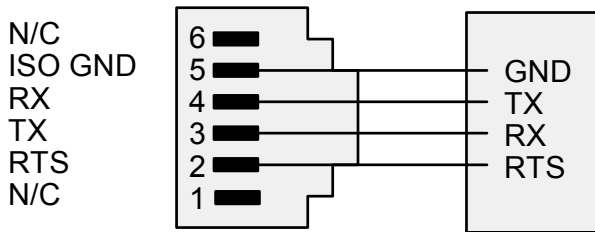

### RS485 INTERFACE - FULL DUPLEX

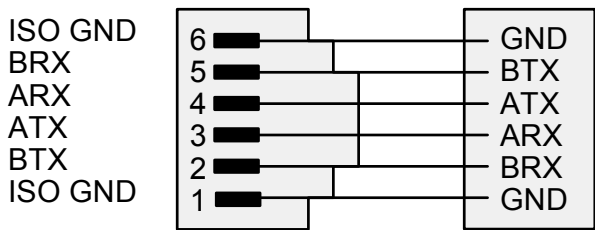

### RS485-MODBUS - FULL DUPLEX

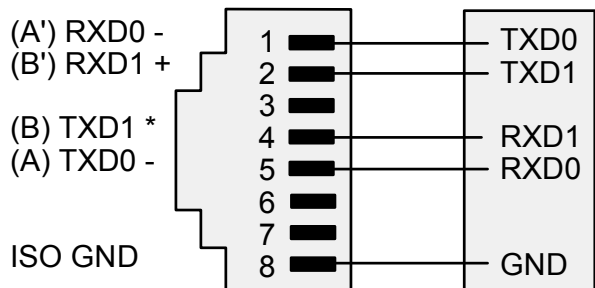

## DUAL SOLID STATE RELAY OUTPUTS

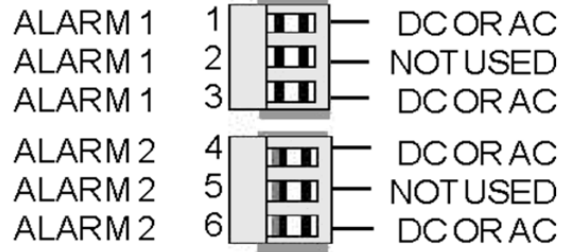

### QUAD SOLID STATE RELAY OUTPUTS

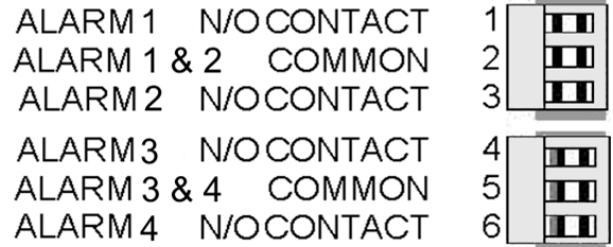

## P4 - SINGLE ANALOG OUTPUT

### UNIPOLAR CONNECTIONS

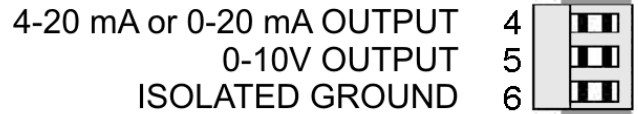

### BIPOLAR CONNECTIONS

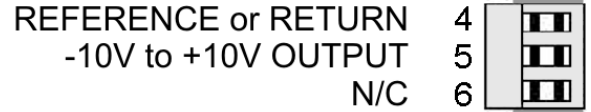

**P4 - DUAL ANALOG OUTPUT**, provides two unipolar connections at pins 1,2,3 and 4,5,6

### RS485 INTERFACE - HALF DUPLEX

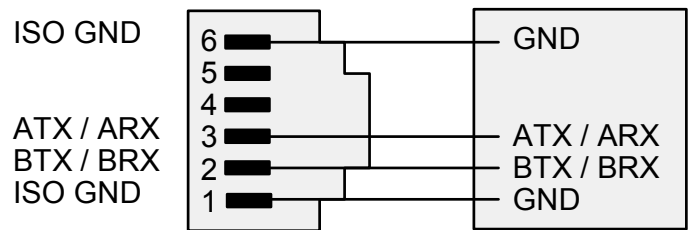

### RS485-MODBUS - HALF DUPLEX

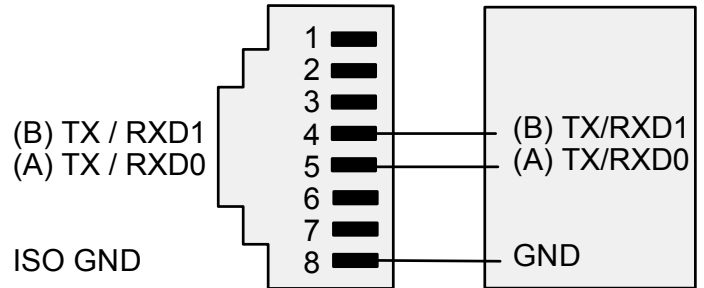

## 7. MECHANICAL ASSEMBLY

### REMOVING THE REAR PANEL

First remove any connectors. Use one hand to press in the two sides of the rear of the case, and the other hand to press down the two protruding tab releases at the top of the rear panel (see figure below). This will unhook the rear panel from the case.

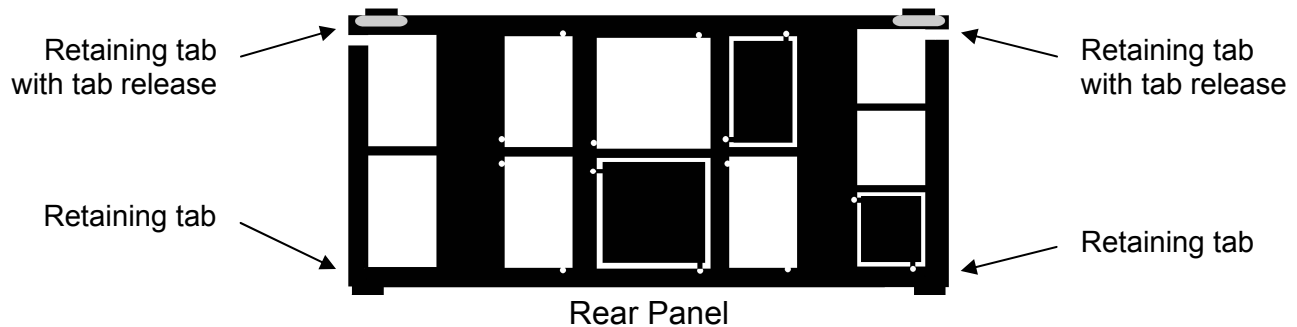

### REMOVING THE ELECTRONICS

With the rear panel removed, grasp the power supply board to the left and signal conditioner board to the right, then carefully slide the electronic assembly out through the rear of the case.

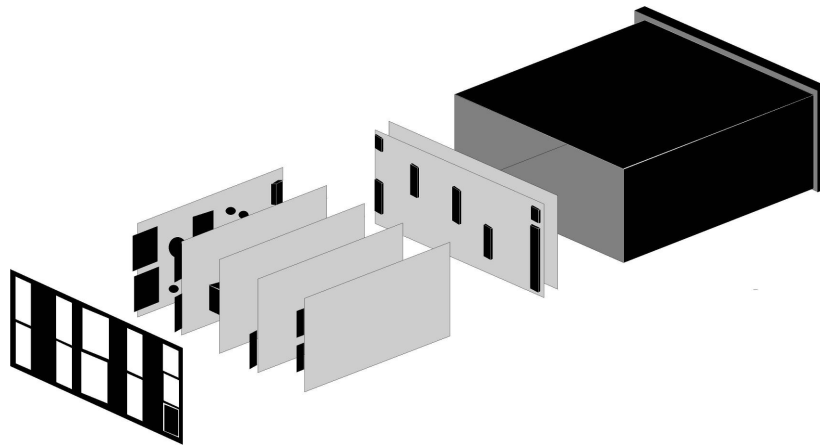

### INSTALLING NEW OPTION BOARDS

Options boards plug into the main board at the front of the meter. These are plug-and-play and may be installed in the field. They will be recognized by the software, which will provide access to the menu items associated with that board. If necessary, remove rear panel knockouts for new boards. Boards plug into connectors as follows:

Option Board	Main Board Plug	Rear Panel Jack
Power supply	P11	J1
Relay board	P12	J2
Serial interface board	P13	J3
Analog output board	P14	J4
Signal conditioner board	P15	J4



**Note:** Corresponding main board and option board connectors have the same number of electrical lines. When an option board is correctly installed, the top and bottom edges of the main board and option board are aligned.

### REASSEMBLING YOUR METER

Slide the electronics assembly into the case until the display board is seated flush against the front overlay. Insert the bottom tabs of the rear panel into the case, then carefully align the board connectors with the openings in the rear panel. If necessary, remove any rear panel knockouts for new option boards that may have been installed. Ensure that all option boards are properly aligned with the molded board retaining pins on the inside of the rear panel. Once the rear panel is in place, reinstall the input/output screw clamp terminal plugs.

### PANEL MOUNTING

Ensure that the panel mounted gasket is in place against the back of the bezel. Turn the two mounting screws counterclockwise until the space between the mounting pawl and the rear of the gasket is greater than the panel thickness. Insert the meter in the panel cutout. Turn the mounting screws clockwise until the meter is securely mounted in the panel. Do not overtighten.

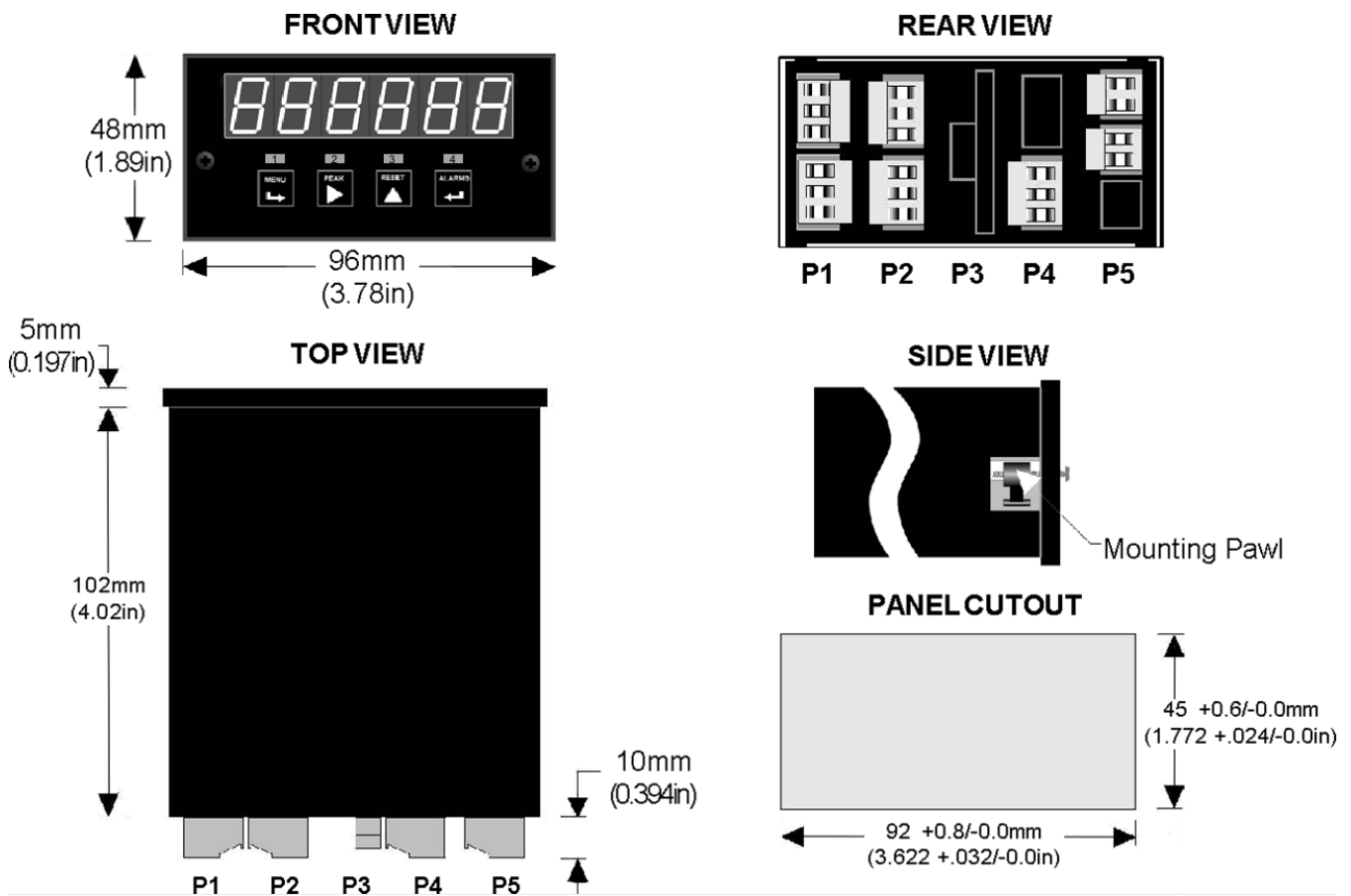

*Dimensioned case drawings*

## 8. FRONT PANEL SETUP KEYS

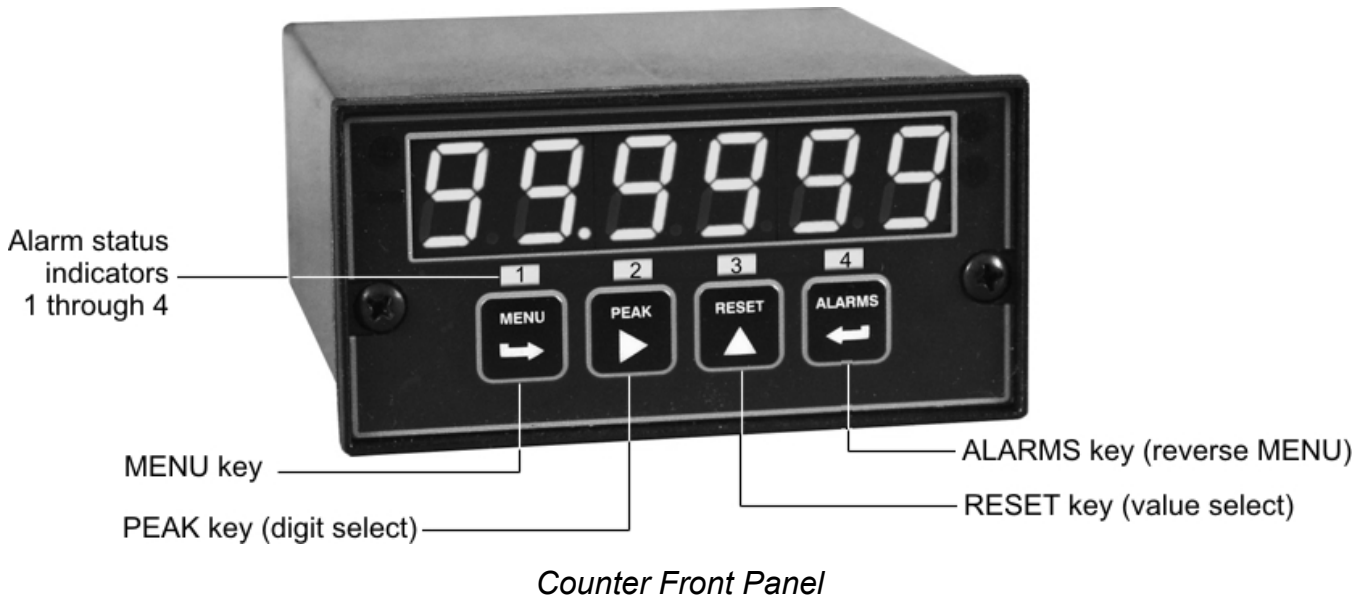

There are four front panel keys, which change function for the **Run Mode** and **Menu Mode**, effectively becoming eight keys. The keys are labeled with alphanumeric captions (MENU, PEAK, RESET, ALARMS) for the Run Mode and with symbols (➡ right arrow, ▶ right triangle, ▲ up triangle, ← left arrow) for the Menu Mode.

### FRONT PANEL LOCKOUT

The Menu Mode will not work with most meters shipped from the factory, since all menu items have been disabled in software and a lockout jumper is in place. This jumper needs to be removed for the Menu Mode to work, and values under **Loc 1** through **Loc 4** need to be set to "0" via the front panel for these menu items to be available. See Section 9. The paragraphs below assume that all lockout features have been removed.

### MENU MODE KEY ACTION

In the Menu Mode, pressing a key momentarily advances to the next item. Holding down the key advances through multiple menu items for fast menu navigation.

### KEYS IN RUN MODE



**MENU Key.** Pressing *MENU* from the Run Mode enters the Menu Mode. Pressing *MENU* repeatedly will step the meter through the various menu items (if these have not been locked out) and then back to the Run Mode.



**PEAK Key.** Pressing *PEAK* causes the peak value of the input signal to be displayed. The peak display blinks to differentiate it from the normal present value display. Pressing *PEAK* again will return the display to the present value.





**RESET Key.** Pressing *RESET* with *PEAK* resets peak and valley values. Pressing *RESET* with *ALARMS* resets latched alarms. Pressing *RESET* with *MENU* performs a meter reset (same as power on). Pressing and releasing *RESET* without pressing another key changes the displayed item if the mode has multiple items. For Item 1, the V LED is out. For Item 2, the V LED is on. For Item 3, the V LED is flashing.



**ALARMS Key.** Pressing *ALARMS* once displays the setpoint for Alarm 1. Pressing it again displays the setpoint for Alarm 2. Pressing it again returns to the present value. After 30 seconds, the meter automatically returns to the present value. Timing is automatically reset whenever the *ALARMS* key is pressed.





## KEYS IN MENU MODE



**Right Arrow Key (MENU).** Pressing  steps the meter through all menu items that have been enabled and then back to the Run Mode. With the dual-channel pulse input signal conditioner board and no option boards, available menu items will be **InPut**, **SEtuP**, **ConFiG**, **dSPYno**, etc. Actual menu items will vary depending on the *Input* selection and boards detected in the meter. If a change has been made to a menu item, that change is saved to non-volatile memory when the  key is pressed next, and **StoreE** is displayed briefly.





**Right Triangle Key (Digit Select).**

- Pressing  from the *InPut* menu brings up all meter functions available with the meter's signal conditioner. For the dual-channel pulse input signal conditioner, these are **rAtE**, **PERiod**, **totAL**, **ti\_Int**, **Stop t**, **PHASE**, **duty C**.
- Pressing  from most menus sequentially selects digit positions 1 - 6, as indicated by a flashing digit: **000000**, **000000**, **000000**, **000000**, **000000**, **000000**.
- Pressing  from *dEC.Pt1* brings up a decimal point display of type **11.1111**. Pressing  from *dEC.Pt2* brings up a decimal point display of type **22.2222**.



**Up Triangle Key (Value Select).**

- Pressing  from a selected meter function, such as **rAtE**, will select the a specific operating mode within that function, such as **A\_OnLy**. Always press the MENU key to save your selection. Do not press the  key to the right, or your selection will be lost.
- Pressing  for a flashing digit position or decimal point position will increment that item. Pressing the MENU key will save any changes.



**Left Arrow Key (Reverse Menu).** Pressing  has the same effect as the MENU key, except that menu items are brought up in reverse order.

## 9. ENABLING & LOCKING OUT MENU ITEMS

For security reasons and ease of operation, any and all menu items may be disabled or "locked out" so that they are no longer directly accessible from the front panel. Each function to be enabled is set to "0" and each function to be disabled is set to "1" in menu items *Loc 1-4*. These menu items can in turn be locked out by installing an internal hardware jumper. With the jumper installed, the operator only has access to enabled menu items. With the jumper removed, the operator also has access to the *Loc 1-4* menu items.

### SETTING HARDWARE LOCKOUT JUMPER

To access the lockout jumper, remove the rear panel per Section 9 and locate jumper "a" in the lower portion of the power supply board next to the input connectors (see figure at right).

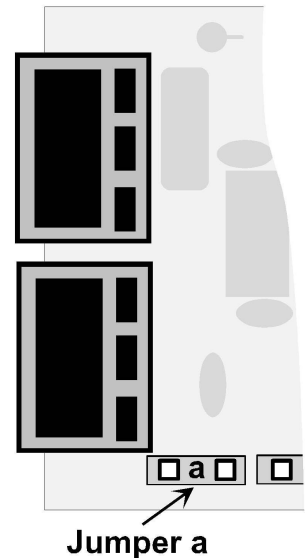

### SETTING SOFTWARE LOCKOUTS

When setting up the meter, it may be necessary to enable specific menu items by setting the corresponding lockout digit to 0. Be sure to reset the lockout digit to "1" if you do not want the menu item to be changed by an operator.

#### **Loc 1** **Loc 2** **Loc 3** **Loc 4**

Press the **→** MENU key until *Loc 1*, *Loc 2*, *Loc 3* or *Loc 4* is displayed, as desired. **Note:** the lockout jumper must be removed (see above).

**111111**

Press **▶** to display the lockout status, consisting of 0's and 1's. The left digit will flash. Press **▶** again to step to the next digit, which will flash.

**000000**  
123456

Press **▲** to set the flashing digit to "0" to enable the menu item or to "1" to disable. Press *MENU* to enter. See the table to the right for list of menu items that can be enabled or disabled.

### Enabled / Disabled Menu Items

#### **Loc 1**

- 3 - Input type selection
- 4 - Setup, Config, Dspyno
- 5 - Gate time, timeout, batch setup
- 6 - Filter setup

#### **Loc 2**

- 3 - Slope, decimal points
- 4 - Scale, offset, resolution, 2-coord.
- 5 - Alarm config, DevHy
- 6 - Alarm setpoint programming

#### **Loc 3**

- 3 - Analog output setup & scaling
- 4 - Serial communications configuration
- 5 - Calibration
- 6 - Change displayed Item #

#### **Loc 4**

- 3 - View peak value
- 4 - View alarm setpoints
- 5 - Front panel resets (peak & latched alarms)
- 6 - Front panel reset (cold reset only)

## 10. DUAL CHANNEL PULSE OR AC INPUT SIGNAL CONDITIONER

The dual channel signal conditioner board is used for the frequency, rate, period, timing, batch control, phase and duty cycle meter functions. The board needs to be configured via jumpers for the input signal type and level. It is recognized by the meter software, which will bring up the applicable menu items. The dual channel pulse input signal conditioner does not require calibration, since the quartz crystal oscillator used for frequency and timing applications is located on the counter main board.

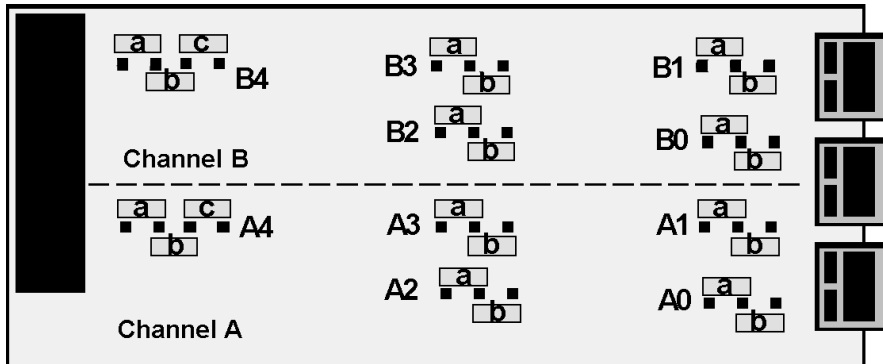

**Note:** Letters indicate jumper position. Jumpers are installed on pins adjacent to letters.

### Jumper Settings for Expected Signal Levels

The jumper settings for Channel A (A2 & A3) and Channel B (B2 & B3) need to be set for the expected signal voltage. This voltage must be outside of the high and low thresholds per the following table, or the meter will not operate properly. The larger the difference between the high and low thresholds, the more immune the meter is to input signal noise.

A3 B3	A2 B2	Input must be		A3 B3	A2 B2	Input must be		A3 B3	A2 B2	Input must be	
		below	above			below	above			below	above
-	a	-12 mV	+12 mV	a	a	+30 mV	+60 mV	b	a	-60 mV	-30 mV
-	b	-150 mV	+150 mV	a	b	+350 mV	+600 mV	b	b	-600 mV	-350 mV
-	-	-1.15V	+1.15V	a	-	+1.25V	+2.1V	b	-	-2.1V	-1.25V

### Jumper Settings for Frequency Response, Bias Resistor, Debounce Time

Pull-up or pull-down resistors are used with open collector devices and dry contact closures to provide input signal bias. They should not be connected for other inputs. Debounce circuitry keeps the meter from counting extra pulses due to contact bounce.

Function	Block	Jumper	Setting
Frequency Response	A0 & B0	-	1 MHz max
		b	30 kHz max
		a	250 Hz max
Bias Resistor	A1 & B1	a	10 kOhm pull-up to 5V
		b	10 kOhm pull-down to -5V
Contact Debounce	A4 & B4	b	None
		a, c	3 msec
		c	50 msec

## Common Jumper Settings

Input Type	Vmax	A0 & B0	A1 & B1	A2 & B2	A3 & B3	A4 & B4
Logic levels	250V	-	-	-	a	b
NPN open collector	NA	b	a	-	a	b
PNP open collector	NA	b	b	-	b	b
Contact closures	NA	a or b	a	-	a	a, c
Line frequency	250V	b	-	-	-	a, c
Turbine flow meter	250V	b	-	a	-	b

## OVERVIEW OF OPERATING MODES

### RATE & FREQUENCY MODES

**Frequency in Hz** is determined by timing an integral number of pulses over a user-specified *gate time* from 0 to 199.99 sec and taking the inverse of average period. The typical display update rate of the meter is gate time + 1 period + 30 ms. Selecting a longer gate time produces a more stable reading as more cycles are averaged, but slows down the update rate. At very low frequencies, the update rate is controlled by the period. A *time-out* from 0 to 199.99 sec is also selectable. This is the time the meter waits for a signal to start or end a conversion. If the signal is not received before the *time-out* ends, the meter reads zero. The longer the time-out, the lower the minimum frequency the meter can display.

With a *scale factor* of 1 and *multiplier* of 1, frequency is displayed in Hz with no decimal point. Applying a multiplier from 1 to 100000 (in decade steps) and setting the decimal point increases resolution (0.1 to 0.00001 Hz). Decreasing the multiplier from 1 to 0.00001 (in decade steps) and setting the decimal point allows display in kHz or MHz. Note that the same 100 kHz frequency can be displayed as 100000 Hz or 100.000 kHz simply by moving the decimal point.

### DISPLAY FREQUENCY IN Hz WITH 1 Hz RESOLUTION

Dig. No.	S	1	2	3	4	5	6						
InPut				r	A	t	E	A O n L y					
SEtuP			0	0	0	0	0						
ConFiG				1	0	0	0						
dSPyno						0	1						
GAtE t			0	0	0.	2	2						
ti Out			0	0	1.	0	0						
FILtEr			0	0	1	0	5						
SLOPE						0	1						
DecPt1		1	1	1	1	1	1.						
SCALE1		1.	0	0	0	0	0	1					
OFFSt1		0	0	0	0	0	0						
CALib	-		0	0	0	0	0	Do Not Change Calib					

**Application:** Display frequency from 1 Hz to 999999 Hz with no decimal, display update rate of 4/sec, and adaptive moving average filter for 6 readings.

**Solution:** Set Input to "Rate A Only." Set Config to display to 999999 counts. Set Gate Time to .22 sec so that the display update rate becomes .22 sec +30 ms +1 period. Set Time-out to 1 sec, so that frequencies under 1 Hz are displayed as 0. Set filter for adaptive moving average with a 1.6 sec time constant. Apply a scale value of 1.00000 and multiplier of 1 for direct readout in Hz.

## DISPLAY 0-50.00 RATE FROM 1-10 kHz INPUT, COORDINATES OF 2 POINTS METHOD

Dig. No.	S	1	2	3	4	5	6
InPut				r	A	t	E
SEtuP			0	0	1	0	0
ConFIG				1	0	0	0
dSPyno						0	1
GAte t			0	0	0.	2	2
ti Out			0	0	1.	0	0
FiLteR			0	0	1	0	5
SLOPE						0	1
DecPt1		1	1	1	1.	1	1
Lo In1		0	0	1	0	0	0
Lo rd1		0	0	0	0.	0	0
Hi In1		0	1	0	0	0	0
Hi rd1		0	0	5	0.	0	0
CALib	-		0	0	0	0	0

Do Not Change Calib

**Application:** Display 0-50.00 (with two decimal places) for 1-10 kHz input. Use coordinates of 2 points scaling method.

**Solution:** Set Input to “Rate A Only.” Select “coordinates of 2 points” scaling method under Setup. This is easier than scale and offset. Set DecPt1 to two places. Then enter the low input and desired low reading, and high input and desired high reading, as shown.

## DISPLAY RATE IN GPM FROM 36.67 PULSE/GALLON TURBINE FLOW METER

Dig. No.	S	1	2	3	4	5	6
InPut				r	A	t	E
SEtuP			0	0	1	0	0
ConFIG				1	0	0	0
dSPyno						0	1
GAte t			0	0	0.	2	2
ti Out			0	0	0.	1	0
FiLteR			0	0	1	0	5
SLOPE						0	1
DecPt1		1	1	1	1.	1	1
Lo In1		0	0	0	0	0	0
Lo rd1		0	0	0	0.	0	0
Hi In1		0	0	3	6.	6	7
Hi rd1		0	0	6	0.	0	0
CALib	-		0	0	1	0	0

Do Not Change Calib

**Application:** Display rate in GPM to two decimal places from flow meter calibrated to 36.67 pulses/gallon.

**Solution:** Set Input to “Rate A Only. Under Setup, select “coordinates of 2 points” scaling method. Set DecPt1 to two places. Then enter the low input and desired low reading, and high input and desired high reading, as shown. In this example, we want to display 60.00 (GPM) from an input of 36.67 Hz. Note that the meter’s native rate measurements are in Hz. There will be 60 times more gallons per minute than per second.

**Rate in engineering units** is displayed from measured frequency by applying an appropriate *scale factor* and setting the decimal point. The *scale factor* consists of a *scale value* from 0.00000 to 9.99999 (fixed decimal point and settable digits) and a *scale multiplier* from 0.00001 to 100000 (in decade steps). When using the *coordinates of 2 points method* to scale the meter, the low input and high input frequencies are entered in Hz.

- **RATE A ONLY (A\_OnLy)** displays rate or frequency for Channel A. The latter utilizes *SCALE1*, *OFFSt1* and *dECPt1*. Channel B is not used.
- **RATE A B (A\_b\_)** displays rate or frequency for Channel A as Item #1 or for Channel B as Item #2. The latter utilizes *SCALE2*, *OFFSt2* and *dECPt2*.
- **RATE A, TOTAL A (A\_Atot)** (Extended counter) displays Rate for Channel A as Item #1 and Total for Channel A as Item #2 since last reset. Total may count down from an offset by entering a negative scale factor. Only used for non-linear inputs.

- **RATE A, TOTAL B (A\_btot)** (Extended counter) displays Rate for Channel A as Item #1 and Total for Channel B as Item #2.
- **RATES A+B, A-B, AxB, A/B, A/B-1** (Extended counter) display arithmetic combinations of Rates A and B as Item #1, Rate A as Item #2, and Rate B as Item #3. With rates A and B scaled to produce a ratio close to 1 and an offset of -1, the special combination A/B-1, called “Draw,” can display percentage changes, such as elongation of material passing between rollers. Channels A and B use DecPt1. The arithmetic combination uses DecPt2 and can be shifted by factors of 10 using a rESoLN (resolution) entry.

**TOTAL MODES**

**DISPLAY TOTAL IN GALLONS FROM 36.67 PULSE/GALLON TURBINE FLOW METER**

Dig. No.	S	1	2	3	4	5	6								
InPut				t	o	t	A	L	A			O	n	L	y
SEtuP			1	0	1	0	0								
ConFIG				1	0	0	0								
dSPyno						0	1								
GAtE t			0	0	0.	0	1								
SLOPE						0	1								
DecPt1		1	1	1	1.	1	1								
Lo In1		0	0	0	0	0	0								
Lo rd1		0	0	0	0.	0	0								
Hi In1		0	0	3	6.	6	7								
Hi rd1		0	0	0	1.	0	0								
CALib	-		0	0	0	0	0	Do Not Change Calib							

**Application:** Display total in gallons with two decimal places for flow meter calibrated to 36.67 pulses/gallon.

**Solution:** Set Input to “Total A Only.” Under Setup, select “Restore totals at power-on” and coordinates of 2 points method. This is the preferred scaling method. Set gate time to its minimum of 0.01 sec for smooth display updates. Set DecPt1 to two places. Then enter low input and desired low reading, and high input and desired high reading for display of 1.00 for 36.67 pulses, as shown.

**DISPLAY SIMULTANEOUS RATE & TOTAL FROM 36.67 PULSE/GALLON FLOW METER**

Dig. No.	S	1	2	3	4	5	6								
InPut				r	A	t	E	A	A	t	o	t			
SEtuP			1	0	1	1	0								
ConFIG				1	1	0	0								
dSPyno						0	1								
GAtE t			0	0	0.	1	0								
ti Out			0	0	1.	0	0								
FiLtEr			0	0	1	0	5								
SLOPE						0	1								
DecPt1		1	1	1	1.	1	1								
DecPt2		2	2	2	2	2	2.								
Lo In1		0	0	0	0	0	0								
Lo rd1		0	0	0	0.	0	0								
Hi In1		0	0	3	6.	6	7								
Hi rd1		0	0	6	0.	0	0								
Lo In2		0	0	0	0	0	0								
Lo rd2		0	0	0	0	0	0								
Hi In2		0	0	6	0	0	0.								
Hi rd2		0	0	0	0	0	1								
CALib	-		0	0	0	0	0	Do Not Change Calib							

**Application:** Display flow rate in GPM with two decimal places and total gallons with no decimal places from the same flow meter signal calibrated to 36.36 pulses/gallon, applied to Channel A

**Solution:** Use an Extended counter, as required for simultaneous rate and total. Set Input to “Rate A A Total.” For flow rate in GPM (Item #1), set DecPt1 to two decimals, and scale the display by entering Lo In1, Lo rd1, Hi In1, Hi rd1 as shown. For total in Gallons (Item #2), set DecPt2 to no decimals, and scale the display by entering Lo In2, Lo rd2, Hi In2, Hi rd2 as shown. Enter a Gate Time, such as 0.1 sec, which is long enough to produce stable rate readings, but is short enough to produce rapid updates of total.



## DISPLAY TOTAL VOLUME BY ADDING TWO TURBINE FLOW METER CHANNELS

Dig. No.	S	1	2	3	4	5	6				
InPut			t	o	t	A	L	A	+	b	
SEtuP			1	0	1	1	0				
ConFIG				1	1	0	0				
dSPyno						0	1				
GAtE t			0	0	0.	0	1				
SLOPE						0	0				
DecPt1		1	1	1	1.	1	1				
DecPt2		2	2	2	2.	2	2				
Lo In1		0	0	0	0	0	0				
Lo rd1		0	0	0	0.	0	0				
Hi In1		0	0	3	6.	6	7				
Hi rd1		0	0	0	1.	0	0				
Lo In2		0	0	0	0	0	0				
Lo rd2		0	0	0	0.	0	0				
Hi In2		0	0	5	8.	1	2				
Hi rd2		0	0	0	1.	0	0				
rESoLn							1				
CALib	-		0	0	0	0	0	Do Not Change Calib			

**Application:** Display total liquid volume in gallons to two decimal places from 2 pipes dispensing liquids into the same tank. Flow meter A is calibrated to 36.67 pulses/gallon, flow meter B to 58.12 pulses/gallon.

**Solution:** Arithmetic operations require the Extended counter. Apply flow meter output A output to Channel A, flow meter output B to Channel B. Set Input to "Total A+B." Set Gate Time to 0.01 sec for fast display updates. Select a positive trigger slope for A and B. Set DecPt2, which applies to Grand Total, and DecPt1, which applies to Totals A and B, both to two decimal places. Under Setup, select the coordinates of 2 points scaling method for A and B. To scale A, enter 36.67 (pulses) for Hi In1 and 1.00 (gallons) for Hi Rd1. To scale B, enter 58.12 (pulses) for Hi In2 and 1.00 (gallons) for Hi Rd2. The normal display will be Item #1 (Grand Total). Press the ▲ key to view Item #2 (Total A) and Item #3 (Total B).

**TOTAL A ONLY (A\_OnLy)** displays the number of pulses applied to Channel A as Item #1. If scientific notation is not selected, overflows beyond 999,999 are recorded in units of 1,000,000 as Item #2. For example, a total of 17,345,676 would be displayed as 345,675 in Item #1 and 17 in Item #2. This capability gives the counter 12-digit capability. Items #1-2 can also be retrieved via serial communications.

- **TOTAL A B (A\_\_b\_\_)** displays Total A as Item #1 or Total B as Item #2.
- **TOTALS A+B, A-B, AxB, A-B, A/B** (Extended counter) display arithmetic combinations of Totals A and B as Item #1, Total A as Item #2, and Total B as Item #3.
- **TOTAL A-B UD (A-b\_Ud)** is the same as TOTAL A-B, except that counts are subtracted on an ongoing basis, instead of subtracting totals. This avoids round-off errors with large totals. Overflows are displayed as #2. (See Total A only)
- **BURST (\_burST)** (Extended counter) displays the total number of signal bursts applied to Channel B as Item #1. Gate time must be greater than the period of the lowest signal frequency and less than the minimum time between bursts. Time-out should be set to 0.
- **TOTAL A B U/D (A\_bU/d)** (Extended counter) displays Total A as Item #1, where the up or down count direction is determined by an input on Channel B. If the menu item *SLOPE* is set to 0 for Channel B, (digit 6), an input level on B below the jumper set Low Threshold B causes the count to go up, and an input level above the jumper set High Threshold causes the count to go down. If *SLOPE* for Channel B is set to 1, the opposite occurs. The maximum frequency on A that can be counted is 250 kHz, or a minimum of 4 μs between pulses.

- **TOTAL A B INHIBIT (A\_bInH)** (Extended counter) displays Total A as Item #1, where counting may be inhibited by a control input on Channel B. If the menu item *SLOPE* is set to 0 for Channel B (digit 6), a low input level on B allows counting, and a high input level inhibits counting. If the *SLOPE* for Channel B is set to 1, the opposite occurs. The maximum frequency on A that can be counted is 1 MHz. Overflows are displayed as #2. (See Total A only)

**BATCH CONTROL MODE (\_bAtCH)**

**BATCH CONTROL WITH A 36.67 PULSE/GALLON TURBINE FLOW METER**

Dig. No.	S	1	2	3	4	5	6
InPut				r	A	t	E
SEtuP			1	0	0	1	0
ConFIG				1	1	0	0
dSPyno						0	1
GAtE t			0	2	0.	0	0
bAtCH			1	0	0	1	0
FILtEr			0	0	1	0	5
SLOPE						0	0
DecPt1		1	1	1	1.	1	1
DecPt2		2	2	2	2.	2	2
SCALE1		2.	7	2	7	0	2
OFFSt1		0	0	0	0	0	0
Lo ln2		0	0	0	0	0	0
Lo rd2		0	0	0	0.	0	0
Hi ln2		0	0	3	6.	6	7
Hi rd2		0	0	6	0.	0	0
rESoLn							1
SourcE				1	1		
AL SET			0	0	2	4	0
dEUn1b		0	0	0	0.	0	0
dEUn2b		0	0	0	0.	0	0
CALib	-		0	0	0	0	0

b A t C H

1

Do Not Change Calib

**Application:** Fill 55 gallon tanks, measuring flow with a 36.67 pulses/gallon flow meter. Slow down filling at 54 gallons. Cycle batches automatically with 20 sec between cycles. Display batch total & fill rate to 2 places. Track number of batches.

**Solution:** Use an Extended counter with a dual relay output board. Apply the flow meter signal to Channels A & B. Set Input to "Rate Batch." Set Batch to count up to Setpoint1. Use Gate Time as delay between batches. Make Item #2 the number of batches. Set Gate Time to 20 sec. Set an adaptive moving average filter, which will apply to rate only, not totals. Set DecPt1 and DecPt2 to two decimal places for Items #1 and #3 (Batch Total and Rate). Scale Item #1 (Batch Total) by entering a Scale1 of 2.72702 (counts per pulse) and a Setpoint1 of 55.00, which will serve as the batch setpoint in gallons. Scale Item #3 (Rate) using the coordinates of 2 points method so that 36.67 pulses/sec will be displayed as 60.00 GPM. Set Setpoint2 to 54.00 to activate Relay 2 to slow the fill rate at 54.00 gallons.

ALARM KEY	S	1	2	3	4	5	6
SETPT1		0	0	5	4.	0	0
SETPT2		0	0	5	5.	0	0

**Batch control** (Extended counter) uses the meter with a dual relay controller board to control repetitive fill operations. Relay #1 is used as the batch relay. Relay #2 (or Setpoint #2) can be assigned to another limit, such as pre-warn to slow filling near the setpoint, end-of-process, or rate alarm. The same signal is applied to Channels A and B. When digit 6 of *bAtCH* (Action after Meter Reset) is set to zero, the following applies:

- **In batch control mode without external resets**, the meter waits until the *RESET* key is pushed. It then energizes Relay #1 and displays the changing Batch Total. When the preset value is reached, Relay #1 de-energizes for the duration of the gate time setting. Relay #1 then re-energizes, the Batch Total resets, and the fill cycle repeats.

- **In batch control mode with external resets**, pushing the *RESET* key initiates cycling. Grounding an external *Gate* input for a minimum of 3.33 ms then starts each new fill cycle by energizing Relay #1 and resetting the Batch Total. *Gate time* is not used.

Three values are tracked and can be separately displayed by pressing the *RESET* key: Item #1, the Batch Total; Item #2, the Grand Total of all batches or Number of Batches (selectable during setup); and Item #3, the Fill Rate.

- **Item #1, Batch Total**, is the total for that batch. It may be configured to count up from 0 to a preset, or to count down from a preset to 0. The preset value is placed in *SETPT1*. *SCALE1* is positive whether counting up or down.
- **Item #2, Grand Total**, is the sum of previous Batch Totals and the current Batch Total. It can overflow to exponential format.
- **Item #2 (alternate), Number of Batches**, is the current count of batches. *SCALE1* does not apply. *dECpt1* is set to 1.
- **Item #3, Fill Rate**, is calculated with a fixed 20 ms (or 1 cycle min) *gate time*. It may be displayed as Item #3.

## PERIOD MODES

- **PERIOD A ONLY (A\_OnLy)** displays period of Channel A as Item #1.
- **PERIOD A B (A\_\_b\_\_)** displays period of Ch A as Item #1 and of Ch B as Item #2.
- **PERIODS A+B, A-B, AxB, A-B, A/B** (Extended counter) display arithmetic combinations of Periods A and B as Item #1, Period A as Item #2, and Period B as Item #3.

## TIMING MODES

### STOPWATCH TIMING, “ON” TIME OF A MACHINE WITH 0.00 HOUR RESOLUTION

Dig. No.	S	1	2	3	4	5	6						
InPut		S	t	o	P		t	A	t	o	b		
SEtuP			1	0	1	1	0						
ConFIG				4	0	0	0						
dSPyno						0	1						
GAtE t			0	0	0.	0	1						
SLOPE						1	0						
DecPt1		1	1	1	1.	1	1						
DecPt2		2	2	2	2	2	2.						
Lo In1		0	0	0	0	0	0						
Lo rd1		0	0	0	0.	0	0						
Hi In1		0	0	3	6	0	0						
Hi rd1		0	0	0	1.	0	0						
Lo In2		0	0	0	0	0	0						
Lo rd2		0	0	0	0	0	0						
Hi In2		0	0	3	6	0	0						
Hi rd2		0	0	0	0	0	1						
CALib	-		0	0	0	0	0					Do Not Change Calib	

**Application:** Display daily “on” time of a machine in hours with 2 decimals. For machine maintenance, also track accumulated hours since last reset.

**Solution:** Tie a relay across the AC input to the machine so that the relay closes to ground when power is applied. Apply the relay output across both the A & B inputs so that the voltage is 5V when the contacts are open and 0V when they are closed. Set Input to “Stopwatch A to B.” Select negative trigger slope for A and positive for B. Under Config, set Display Mode to sec. Set Gate Time to 0.01 sec. Select the coordinates of 2 points scaling method for Item #1 (daily time) and Item #2 (accumulated time). For Item #1, set DecPt1 to 2 places, set Hi In1 to 3600 (sec) and Hi Rd1 to 1.00 (hrs). For Item #2, set DecPt2 to 0 places, set Hi In2 to 3600 and Hi Rd2 to 1 (hr).

## STOPWATCH TIMING, CLOSING TIME OF A RELAY TO 0.001 MSEC RESOLUTION

Dig. No.	S	1	2	3	4	5	6								
InPut		S	t	o	P		t	A		t	o		b		
SEtuP			1	0	1	1	0								
ConFIG				4	0	0	0								
dSPyno						0	1								
GATe t			0	0	0.	0	1								
SLOPE						0	0								
DecPt1		1	1	1.	1	1	1								
DecPt2		2	2	2	2	2	2.								
Lo In1		0	0	0	0	0	0								
Lo rd1		0	0	0.	0	0	0								
Hi In1		1.	0	0	0	0	0								
Hi rd1		9	9	9.	9	9	9								
Lo In2		0	0	0	0	0	0								
Lo rd2		0	0	0	0	0	0								
Hi In2		0	0	0	0	0	0								
Hi rd2		0	0	0	0	0	0								
CALib	-		0	0	1	0	0	Do Not Change Calib							

**Application:** Measure the closing time of a relay in msec to 0.001 msec resolution.

**Solution:** To close the relay, apply the same positive voltage to the relay coil and to meter Channel A. Wire the relay so that 0V is applied across Channel B when the contacts are closed. Set Input to “Stopwatch A to B.” Select a positive trigger slope for A and a negative trigger slope for B. Under Config, set Display Mode to sec. Set Gate Time to 0.01 sec. Select the coordinates of 2 points scaling method for Item #1. Set DecPt1 to 3 places. Set Hi In1 to 1.00000 (sec) and Hi Rd1 to 999.999 (msec). Ignore Item #2, which is not used.

- TIME INTERVAL A TO B (A\_to\_b)** measures time between periodic inputs on Channels A and B. Timing starts when a pulse is applied to Channel A (positive edge if slope A is 0, negative edge if slope A is 1), and ends when a pulse is applied to Channel B (positive edge if slope B is 0, negative edge if slope B is 1). Pulse width may be measured by tying inputs A and B together and selecting a positive or negative edge to start (Slope A) and the opposite polarity edge to stop (Slope B). If multiple start and stop pulses occur during the *gate time*, the displayed value is the average of pulse widths. The value is updated at the end of each *gate time*. With a scale factor of 1, one count is one microsecond.
- INVERSE TIME INTERVAL ( \_\_1/Ab)** (Extended counter)  
 Takes the inverse of time interval for a reading in /second. For example, if the average time interval for object to travel from point A to point B is 5 seconds, the inverse time interval would be 0.2/sec. For the average speed of the objects, simply apply a scale factor equal to the distance separating the two points, such as 7 (inches). Speed would then be displayed as  $7 \times 0.2 = 1.4$  (inches/sec). For a 6-digit reading, apply a scale multiplier of 10,000 and move the decimal point.
- STOPWATCH A TO A (A\_to\_A)** measures time between the same positive (or negative) edge of start and stop pulses applied to Channel A. Single event times may be displayed as Item #1 in decimal seconds, minutes or hours, or in HH:MM:SS clock format. Time is reset to 0 when a new start pulse occurs. Accumulated total time may be displayed as Item #2. With a scale factor of 1, one count is one microsecond.
- STOPWATCH A TO B (A\_to\_B)** measures time between a start pulse on Channel A and a stop pulse on Channel B. Timing is the same as for A to A, except that positive or negative edges may be selected separately for Channels A and B. This allows the pulse width measurement of single pulses by tying Channels A and B together. One slope is selected to start timing, and the opposite slope to stop timing.

- **INVERSE STOPWATCH TIME A TO A & A TO B ( $\frac{1}{AA}$  &  $\frac{1}{AB}$ )** (Extended counter)  
 Takes the inverse of stopwatch time for a reading in /second. For example, if the travel time for an object to travel from point A to point B is 5 seconds, the inverse stopwatch time interval would be 0.2/sec. For the speed of that object, simply multiply by a scale factor equal to the distance separating the two points, such as 7 (inches). Speed would then be displayed as  $7 \times 0.2 = 1.4$  (inches/sec). For a 6-digit reading, apply a scale multiplier of 10,000 and move the decimal point.

**DUTY CYCLE MODE (duty\_C)** (Extended counter)

Measures ON or OFF period of periodic square waves as a percentage of total period over a *gate time* which is selectable from 10 ms to 199.99 s. The same signal is applied to Channels A and B. ON or OFF time is measured between positive and negative edges of the signal, with averaging over multiple integral periods over the selected gate time. Apply a scale factor of 1 for readings in percent. Apply a 10 or 100 multiplier and move the decimal point by 1 or 2 positions for 0.1% or 0.01% resolution.

**PHASE ANGLE MODE (PHASE)** (Extended counter)

Measures the phase relationship in degrees between two signals with the same period over a *gate time* which is selectable from 10 ms to 199.99 s, with averaging over multiple integral periods over the selected gate time. The two signals are applied to Channels A and B. For best accuracy, both signals should have the same amplitude. The amplitude of sinusoidal signals should be larger than 1V, and the trigger level should be set at 12 mV (no jumper at A3 or B3, jumper a at A2 and B2).

**PHASE ANGLE MEASUREMENT TO 0.01° RESOLUTION**

Dig. No.	S	1	2	3	4	5	6					
InPut			P	H	A	S	E	-	1	8	0	+
SEtuP			0	0	1	0	0					
ConFiG				1	1	0	0					
dSPyno						0	1					
GAtE t			0	0	0.	2	2					
ti Out			0	0	1.	0	0					
bAtCH			0	0	0	0	0					
FiLteR			0	0	1	0	5					
SLOPE						0	0					
DecPt1		1	1	1	1.	1	1					
Lo In1		0	0	0	0	0	0					
Lo rd1		0	0	0	0.	0	0					
Hi In1		1.	0	0	0	0	0					
Hi rd1		0	0	0	1.	0	0					
CALib	-		0	0	0	0	0	Do Not Change Calib				

**Application:** Measure phase angle difference to 0.01° resolution between two AC signals centered around 0°.

**Solution:** Use an Extended counter, as required for phase angle measurement. Jumper the signal conditioner for maximum sensitivity to catch zero voltage crossings and minimize the effects of amplitude jitter. Apply one AC signal to Channel A and one to Channel B. Set Input to “PHASE +/- 180°.” The display will be in degrees. Set a gate time of 0.22 sec for 4 display updates per sec. Set both trigger slopes to positive. Set two decimal places. Select the coordinates of 2 points scaling method. Set Hi In1 to 1.00000 (degrees) and Hi Rd1 to 1.00 (degrees). As an alternative, select the scale and offset scaling method. Then simply select a scale value of 1.00000 and a multiplier of 100.

## POWER FACTOR MODE (PHASE) (Extended counter)

The power factor of an AC power system is the ratio of real power in watts (W) divided by apparent power in volt-amperes (VA). For sinusoidal signals differing by a phase angle  $\theta$ , power factor will be  $\cos(\theta)$ , which is how the meter computes power factor.

Power Factor readings can range from 1.000 to 0.000 with three decimal places and an accuracy of 0.1% for sinusoidal signals at 50/60 Hz AC line frequency. Maximum frequency is 1 kHz. While Power Factor is always positive, the meter artificially assigns a minus sign to Power Factor for negative phase angles, and it sets Power Factor to 0 for phase angles greater than  $90^\circ$ .

## POWER FACTOR MEASUREMENT TO 0.001 RESOLUTION

Dig. No.	S	1	2	3	4	5	6
InPut			P	H	A	S	E
SEtuP			0	0	0		0
ConFiG				0	2	0	0
dSPyno						0	1
GATe t			0	0	0.	2	2
ti Out			0	0	1.	0	0
bAtCH			0	0	0	0	0
FILtEr			0	0	1.	0	5
SLOPE						0	0
DecPt1		1	1	1.	1	1	1
SCALE1		1.	0	0	0	0	0
OFFSt1		0	0	0.	0	0	0
CALib	-		0	0	0	5	4

**Application:** Display power factor to 0.001 resolution between two AC voltage waveforms.

**Solution:** Use an Extended counter, as for phase angle measurement. Jumper the signal conditioner for maximum sensitivity to catch zero voltage crossings and minimize the effects of amplitude jitter. Apply AC signals to channels A and B. Set Input to "PHASE -180+". Set gate time of 0.22 sec for 4 display updates per sec. Set Config to 0200. SCALE and OFFSt are not used.

Power Factor is stored in the custom curve section of the Extended counter and uses "PHASE -180+" as the input type. Setting ConFiG to X1XX sets up for Phase Angle. Setting ConFiG to X2XX enables Power Factor scaling. First set up the unit as a phase meter and verify that it is working properly. You will need to set the jumpers on the signal input board for the signal level to be applied to the A and B inputs.

The decimal point is set to xxx.xxx . Scale and Offset are disabled.

Power Factor is displayed as a value from -0 to -1 and +1 to +0, with a discontinuity at -1, +1 corresponding to zero phase angle. As the display traverses the range from -0 to -1 and +1 to +0, an Output Control Value (OCV) is created that extends from 0 to +2.000 with a continuous positive slope and no discontinuity at zero phase angle.

The first half of OCV is created by assuming the absolute value of the display value from -0 to -1, and hence becomes 0 to +1.000. The second half of OCV is created by subtracting the displayed value +1 to 0 from 2.000, and hence becomes +1.000 to +2.000. While never displayed, OCV is the source value for determining the analog output, for setpoint comparisons, and for filtering purposes, as it eliminates the discontinuity observed at zero phase angle.

### Example of Using OCV of 0 to 2.000 for setting Analog Output

4 mA output is desired for Power Factor of -0.4 (OCV = 0.400).

20 mA output is desired for Power Factor of +0.4 (OCV = 2.000 - 0.4 = 1.600).

Set up as follows: deC.Pt to 111.111, AnSEt to 21, An\_Lo to +0.400 (4 mA point), An\_Hi to +1.600 (20 mA point), dEC.Pt as desired to 111.111, 1111.11 or 11111.1

### Example of Using OCV of 0 to 2.000 for setting the Alarm Setpoints

It is desired to operate Relay1 when the Power Factor falls outside of  $\pm 0.75$  display range (or outside of 0.750 to 1.250 OCV range).

Set up as follows: ConFig to x1xx to take meter out of Power Factor, dEC.Pt to 111.111, SEtPt1 to 1.000, AL\_SEt to 00000, dEUtn1 to 0.250 to activate Relay1 above 1.250 and below 0.750, dEC.Pt as desired to 111.111, 1111.11 or 11111.1 . Return meter to Power Factor mode by setting ConFig to x2xx

### DUTY CYCLE MEASUREMENT TO 0.01% RESOLUTION

Dig. No.	S	1	2	3	4	5	6						
InPut		d	u	t	y		C	A	t	o	b		
SEtuP			0	0	1	0	0						
ConFIG				1	1	0	0						
dSPyno						0	1						
GAtE t			1	0	0.	0	0						
ti Out			1	9	9.	9	9						
FiLteR			0	0	1	0	5						
SLOPE						0	1						
DecPt1		1	1	1	1.	1	1						
Lo In1		0	0	0	0	0	0						
Lo rd1		0	0	0	0.	0	0						
Hi In1		1.	0	0	0	0	0						
Hi rd1		0	0	0	1.	0	0						
CALib	-		0	0	0	0	0					Do Not Change Calib	

**Application:** Measure “on” period of periodic pulses as a % of total period with .01% resolution over a time interval of 100 sec.

**Solution:** Duty cycle requires the Extended counter. Apply the same signal to Channels A & B. Set Input to “Duty Cycle (A to B) / A.” The native counts will be in percent. For a positive “on” pulse, set trigger slope to positive for A and negative for B. Select the coordinates of 2 points scaling method. Set Hi In1 to 1.00000 (percent) and Hi Rd1 to 1.00 (percent). As an alternative, select the scale and offset scaling method. Then simply select a scale value of 1.00000 and a multiplier of 100.



### 1/RATE MODE FOR TIMING (Extended Counter)

An example of 1/Rate is the time it takes an item takes to travel through an oven at a measured rate. Like Rate, 1/Rate can be scaled using Scale1 and Offset1. With no offset and Scale1 set to 1, Rate A for the full analog input range will be displayed as 0-100000, and 1/A will be displayed as 1000000/A. Both the A and 1/A readings are multiplied by Scale1 and offset by Offset1. With Scale1 set to 1, A is displayed as 10000, and 1/A is displayed as 100. With Scale1 set to 2, A is displayed as 20000, and 1/A is displayed as 200. If square root extraction is applied to rate, the rate display A is replaced by  $\sqrt{A}$ , and 1/A is replaced by  $1/\sqrt{A}$ . 1/A does not apply to custom curves.



Scaling may also be done by using the coordinates of 2 points method, which automatically calculates scale and offset for the displayed value when the low and high input signals and the corresponding desired low and high displayed values are entered.



## SETUP OF COUNTERS WITH DUAL CHANNEL PULSE SIGNAL CONDITIONER



If the **MENU**  key does not work, see Section 9 “Enabling & Locking Out Menu Items.” Menus are dynamic. Menu items will only appear if appropriate for previously made menu selections. For example, Batch menu items will only appear if “Batch” was selected under “Rate.” Extended counter items will only appear if “Extended” was selected under “Config.”



 <b>MENU</b> Press Menu	 <b>PEAK</b> Press Digit Select Key	 <b>RESET</b> Press Value Select Key		
<b>InPut</b> Input	<b>rAtE</b> Rate modes	Basic	<b>A b</b> Rate for Channel A (Item #1). Rate for Channel B (Item #2).	
			<b>A_OnLy</b> Rate for Channel A only (Item #1).	
		Extended meter only	<b>bAtCH</b> Batch control mode. Batch total (Item #1). Grand total or number of batches (Item #2). Fill rate (Item #3).	
			<b>A Atot</b> Rate for Channel A (Item #1). Total for Channel A (Item #2).	
			<b>A btot</b> Rate for Channel A (Item #1). Total for Channel B (Item #2).	
			<b>A + b</b> Sum of rates A & B (Item #1). Rate A (Item #2). Rate B (Item #3).	
			<b>A - b</b> Difference of rates A and B (Item #1). Rate A (Item #2). Rate B (Item #3).	
			<b>A . b</b> Product of rates A and B (Item #1). Rate A (Item #2). Rate B (Item #3).	
			<b>A / b</b> Rate A divided by rate B (Item #1). Rate A (Item #2). Rate B (Item #3).	
			<b>A/b-1</b> Draw, rate A / rate B -1 (Item #1). Rate A (Item #2). Rate B (Item #3).	
			Basic	<b>A b</b> Period Channel A (Item #1). Period for Channel B (Item #2).
				<b>A_OnLy</b> Period for Channel A only (Item #1).
		Extended meter only	<b>A + b</b> Sum of periods A and B (Item #1). Period A (Item #2). Period B (Item #3).	
			<b>A - b</b> Difference of periods A and B (Item #1). Period A (Item #2). Period B (Item #3).	
<b>A . b</b> Product of periods A and B (Item #1). Period A (Item #2). Period B (Item #3).				
<b>A / b</b> Ratio, period A divided by period B (Item #1). Period A (Item #2). Period B (Item #3).				
<b>Period</b> Period modes				





 <b>Press Menu</b>	 <b>Press Digit Select Key</b>	 <b>Press Value Select Key</b>	
<b>InPut</b> (continued)	<b>totAL</b> Total modes	Basic	<b>A b</b> Total for Channel A (Item #1). Total for Channel B (Item #2).
			<b>A_OnLy</b> Total for Channel A only (Item #1).
		Extended meter only	<b>A-b_Ud</b> Running total (Item #1) of counts on Channel A minus counts on Channel B.
			<b>burSt</b> Count of bursts (Item #1). Burst frequency (Item #2).
			<b>b_ArAt</b> Total for Channel B (Item #1). Rate for Channel A (Item #2)
			<b>A_bU/d</b> Total for Channel A (Item #1) with up/down control via Channel B.
			<b>A b InH</b> Total for Channel A (Item #1) with count inhibit control via Channel B.
			<b>A + b</b> Sum of totals A and B (Item #1). Total A (item #2). Total B (Item #3).
			<b>A - b</b> Difference of totals A and B (Item #1). Total A (item #2). Total B (Item #3).
			<b>A . b</b> Product of totals A and B (Item #1). Total A (item #2). Total B (Item #3).
			<b>A / b</b> Ratio of totals A and B (Item #1). Total A (item #2). Total B (Item #3).
			Basic
		Ext.	
		<b>StoP_t</b> Stopwatch modes	Basic
<b>A to b</b> Single event time (Item #1) with pulses on Channels A &B, or accumulated total time (Item #2).			
Extended	<b>1/AA</b> Inverse of stopwatch time (/sec) (Item #1) for single events with pulse signals applied to A & A.		
	<b>1/Ab</b> Inverse of stopwatch time (/sec) (Item #1) for single events with pulse signals applied to A & B.		

<b>MENU</b>  <b>Press Menu</b>	<b>PEAK</b>  <b>Press Digit Select Key</b>	<b>RESET</b>  <b>Press Value Select Key</b>
<b>InPut</b> (continued)	<b>PHASE</b> Phase angle modes	Extended <b>0-360</b> Span from 0° to 360°. Select for phase angles centered around 180° (Item #1).
		<b>-180+</b> Span from -180° to +180°. Select for phase angles centered around 0° (Item #1).
	<b>duty_C</b> Duty cycle mode	Ext. <b>A to b</b> On or Off period of square waves as a percentage of total period (Item #1).
<b>SEtUP</b> Setup	<b>00000</b> Stored totals	<b>0</b> Zero totals at power-on. <b>1</b> Restore totals at power-on.
	<b>00000</b> Leading zeros	<b>0</b> Blank leading zeros. <b>1</b> Display leading zeros.
	<b>00000</b> Scaling method 1	<b>0</b> Input scale factor 1 and offset 1. <b>1</b> Use coordinates of 2 points method.
	<b>00000</b> Scaling method 2	<b>0</b> Input scale factor 2 and offset 2. <b>1</b> Use coordinates of 2 points method.
	<b>00000</b> Operation of rear connector control inputs 1 & 2. <b>True</b> = 0V or tied to digital ground). <b>False</b> = 5V or open).	<b>0</b> 1 = Meter Reset*, 2 = Function Reset* <b>1</b> 1 = Meter Reset*, 2 = Meter Hold* <b>2</b> 1 = Meter Reset*, 2 = Peak or Valley Display* <b>3</b> 1 = Meter Reset*, 2 = External Gate* <b>4</b> 1 = Function Reset*, 2 = Meter Hold* <b>5</b> 1 = Valley Only Display**, 2=Peak Only Display** <b>6</b> 1 = Function Reset*, 2 = External Gate* <b>7</b> 1 = Meter Hold**, Peak or Valley Display** <b>8</b> 1 = Reset Total A**, 2 = Reset Total B** <b>9</b> 1 = Force Alarm1, 2 = Force Alarm2 <b>A</b> 1 = Meter Reset*, 2 = Display Blank* <b>B</b> 1 = Function Reset*, 2 = Display Blank* <b>C</b> 1 = Meter Hold*, 2 = Display Blank* <b>D</b> 1 = Peak or Valley Display**, 2 = Display Blank** <b>E</b> 1 = Display Blank, 2 = External Gate* <b>F</b> 1 = Display Item #2, 2 = Display Item #3 With 1 and 2 at 5V or open, Display Item #1.
	<p>* 1 &amp; 2 both at 0V = Meter Reset (can restore totals).</p> <p>** 1 &amp; 2 both at 0V for selections <b>5</b>, <b>7</b>, <b>8</b>, <b>D</b> = Function Reset* (erases all totals).</p>	

<b>MENU</b>  <b>Press Menu</b>	<b>PEAK</b>  <b>Press Digit Select Key</b>	<b>RESET</b>  <b>Press Value Select Key</b>
<b>ConFIG</b> Configu- ration	<b>0000</b> Display mode	<b>0</b> Normal, overload to exponential format <b>1</b> Normal, overload to 999999 <b>2</b> 1 right-hand dummy zero <b>3</b> 2 right-hand dummy zeros <b>4</b> Time display in seconds <b>5</b> Time display in HH.MM.SS format <b>6</b> Remote display (H, K, L commands) <b>7</b> Single-value remote display <b>8</b> Show 1 <sup>st</sup> string value, slaved to another meter <b>9</b> Show 2 <sup>nd</sup> string value, slaved to another meter <b>A</b> Show 3 <sup>rd</sup> string value, slaved to another meter <b>B</b> Show 4 <sup>th</sup> string value, slaved to another meter <b>C</b> Custom Start, Stop, Skip, Show
	<b>0000</b> Counter mode	<b>0</b> Basic counter <b>1</b> Extended counter <b>2</b> Extended counter, custom curve linearization
	<b>0000</b> Square root	<b>0</b> Linear rate input. <b>1</b> Square root rate input.
	<b>0000</b> Not applicable	<b>0</b> Set to 0.
<b>dSPyno</b> Display #	<b>01</b> PEAK key action	<b>0</b> Display Peak <b>1</b> Display Valley <b>2</b> Peak (1 <sup>st</sup> push), Valley (2 <sup>nd</sup> push)
	<b>01</b> Item to display after Meter Reset*	<b>1</b> Item #1* <b>2</b> Item #2* <b>3</b> Item #3*
<b>GAte t</b> Gate time*	<b>000.00</b> <b>000.00</b> <b>000.00</b> <b>000.00</b> <b>000.00</b> Select digit to flash.	Select <b>0</b> thru <b>9</b> for flashing digit to set gate time* in seconds. Decimal point location is fixed for 10 ms resolution.
<b>ti_Out</b> Time-out*	<b>000.00</b> <b>000.00</b> <b>000.00</b> <b>000.00</b> <b>000.00</b> Select digit to flash.	Select <b>0</b> thru <b>9</b> for flashing digit to set time-out* in seconds. Decimal point location is fixed for 10 ms resolution.
<b>bAtCH</b> Batch setup	<b>00000</b> Handling of overshoot count at end of batch.	<b>0</b> Do not count extra pulses after Preset. Add Preset values to Grand Total. <b>1</b> Count all pulses. Add Preset values to Grand Total. <b>2</b> Do not count extra pulses after Preset. Add Preset values to Grand Total. <b>3</b> Count extra pulses after Preset. Add actual Batch Totals to Grand Total.
	<b>00000</b> Count direction	<b>0</b> Reset batch to 0 and count up to Setpoint 1. <b>1</b> Reset batch to Setpoint 1 and count down.
	<b>00000</b> Batch triggering	<b>0</b> Use internal gate time as delay between batches <b>1</b> Use External Input B to trigger each new batch.

<b>MENU</b>  <b>Press Menu</b>	<b>PEAK</b>  <b>Press Digit Select Key</b>	<b>RESET</b>  <b>Press Value Select Key</b>
<b>bAtCH</b> (continued)	<b>00000</b> Definition of Item #2	<b>0</b> Make Item #2 the Grand Total of all batches. <b>1</b> Make Item #2 the Total Number of batches.
	<b>00000</b> Action after Meter Reset	<b>0</b> Display "rEAdy." <i>RESET</i> key starts batching. <b>1</b> Start batching upon Meter Reset.
<b>FiLteR</b> Filtering	<b>00000</b> Filter type	<b>0</b> Adaptive moving average filter. Restarts filter for high actual changes in signal. <b>1</b> Conventional moving average filter without reset.
	<b>00000</b> Peak & Valley filtering	<b>0</b> Peak* or Valley* value from unfiltered signal. <b>1</b> Peak* or Valley* value from filtered signal.
	<b>00000</b> Display filtering	<b>0</b> Display value of unfiltered signal. <b>1</b> Display value of filtered signal.
	<b>00000</b> Adaptive filter threshold	<b>0</b> Set adaptive filter for normal noise. <b>1</b> Set adaptive filter for presence of high transients.
	<b>00000</b> Filter time constant	<b>0</b> No filter <b>1</b> 0.1 sec <b>2</b> 0.2 sec <b>3</b> 0.4 sec <b>4</b> 0.8 sec <b>5</b> 1.6 sec <b>6</b> 3.2 sec <b>7</b> 6.4 sec
<b>SLOPE</b> Triggering	<b>00</b> Trigger slope, Channel A	<b>0</b> Positive slope <b>1</b> Negative slope
	<b>00</b> Trigger slope, Channel B	<b>0</b> Positive slope <b>1</b> Negative slope
<b>dEC.Pt1</b> Decimal pt1	<b>1.11111</b> Decimal point flashes.	<b>1.11111 11.1111 111.111 1111.11 11111.1 111111.</b> Press ▲ to shift the decimal point.
<b>dEC.Pt2</b> Decimal pt2	<b>2.22222</b> Decimal point flashes.	<b>2.22222 22.2222 222.222 2222.22 22222.2 222222.</b> Press ▲ to shift the decimal point.
Scale and Offset scaling method if selected under <b>SEtuP</b>		
<b>SCALE1</b> Scale Factor 1	<b>0.00000 0.00000 0.00000</b> <b>0.00000 0.00000 0.00000</b> Select digit to flash for Scale Value. When right digit flashes, press ► one more time for the Scale Multiplier.	Select <b>9</b> thru <b>9</b> for flashing first digit and <b>0</b> thru <b>9</b> for other flashing digits. This will set the Scale Value* from -9.99999 to 9.99999 with a fixed decimal point. Then press ▲ to select a value from <b>0.00001</b> to <b>100000</b> in decade steps for the Scale Multiplier. Scale Factor = Scale Value x Scale Multiplier.
<b>OFFSt1</b> Offset 1	<b>000000 000000 000000</b> <b>000000 000000 000000</b> Select digit to flash.	Select <b>9</b> thru <b>9</b> for flashing first digit and <b>0</b> thru <b>9</b> for other flashing digits. Use <b>dEC.Pt1</b> to set the decimal point.
<b>SCALE2</b>	Scale Factor 2. Same setup process as for Scale Factor 1.	
<b>OFFSt2</b>	Offset 2. Same setup process as for Offset 1.	

 <b>MENU</b> Press Menu	 <b>PEAK</b> Press Digit Select Key	 <b>RESET</b> Press Value Select Key
Coordinates of 2 points scaling method if selected under <b>SEtuP</b>		
<b>Lo_In1</b> Low signal input 1.	<b>000000 000000 000000</b> <b>000000 000000 000000</b> Select digit to flash.	Select <b>9</b> thru <b>9</b> for flashing first digit and <b>0</b> thru <b>9</b> for other flashing digits. Move decimal point location when flashing.
<b>Lo_rd1</b> Reading at Lo In1.	<b>000000 000000 000000</b> <b>000000 000000 000000</b> Select digit to flash.	Select <b>9</b> thru <b>9</b> for flashing first digit and <b>0</b> thru <b>9</b> for other flashing digits. Decimal point is fixed by <b>dEC.Pt1</b> .
<b>Hi_In1</b> High signal input 1.	<b>000000 000000 000000</b> <b>000000 000000 000000</b> Select digit to flash.	Select <b>9</b> thru <b>9</b> for flashing first digit and <b>0</b> thru <b>9</b> for other flashing digits. Move decimal point location when flashing.
<b>Hi_rd1</b> Reading at Hi In1.	<b>000000 000000 000000</b> <b>000000 000000 000000</b> Select digit to flash.	Select <b>9</b> thru <b>9</b> for flashing first digit and <b>0</b> thru <b>9</b> for other flashing digits. Decimal point is fixed by <b>dEC.Pt1</b> .
<b>Lo_In2</b> Low signal input 2.	<b>000000 000000 000000</b> <b>000000 000000 000000</b> Select digit to flash.	Select <b>9</b> thru <b>9</b> for flashing first digit and <b>0</b> thru <b>9</b> for other flashing digits. Move decimal point location when flashing.
<b>Lo_rd</b> Reading at Lo In2.	<b>000000 000000 000000</b> <b>000000 000000 000000</b> Select digit to flash.	Select <b>9</b> thru <b>9</b> for flashing first digit and <b>0</b> thru <b>9</b> for other flashing digits. Decimal point is fixed by <b>dEC.Pt1</b> .
<b>Hi_In2</b> High signal input 1.	<b>000000 000000 000000</b> <b>000000 000000 000000</b> Select digit to flash.	Select <b>9</b> thru <b>9</b> for flashing first digit and <b>0</b> thru <b>9</b> for other flashing digits. Move decimal point location when flashing.
<b>Hi_rd2</b> Reading at Hi In1.	<b>000000 000000 000000</b> <b>000000 000000 000000</b> Select digit to flash.	Select <b>9</b> thru <b>9</b> for flashing first digit and <b>0</b> thru <b>9</b> for other flashing digits. Decimal point is fixed by <b>dEC.Pt1</b> .
Preset function. Displayed for Total modes <b>A-b Ud</b> or <b>A bU/d</b>		
<b>PrESet</b> Preset*	<b>000000 000000 000000</b> <b>000000 000000 000000</b> Select digit to flash.	Select <b>9</b> thru <b>9</b> for flashing first digit and <b>0</b> thru <b>9</b> for other flashing digits. <b>dEC.Pt1</b> is used. When the meter counts up and reaches the Preset, it reverts to Offset1. When the meter counts down and reaches Offset1, it reverts to Preset. Set to 0 for no Preset.
Special curve offset for square root or custom curve linearization if selected under <b>ConFiG</b>		
<b>rd0_In</b>	<b>000000 000000 000000</b> <b>000000 000000 000000</b> Select digit to flash.	Select <b>9</b> thru <b>9</b> for flashing first digit and <b>0</b> thru <b>9</b> for other flashing digits. Decimal point is fixed by <b>dEC.Pt1</b> .

Scale multiplier for combinations of two channels (e.g., AxB, A/B) if selected under <b>InPut</b>		
<b>rESoLn</b> Resolution	Flashing 6-digit number in decade steps from <b>0.00001</b> to <b>100000</b>	Press <b>▲</b> to select. This is a multiplier <b>R</b> to avoid overflow or underflow of arithmetic combinations of Channels A and B.
Quartz crystal time base calibration		
<b>_CALib</b>	Time base calibration.	Do not change. See Calibration section of manual.
Option dependent menu items		
<b>SourceE</b> <b>AL SET</b> <b>AL S34</b> <b>dEUn1H</b> <b>dEUn2H</b> <b>dEUn1b</b> <b>dEUn2b</b> <b>dEUn3H</b> <b>DEUn4H</b> <b>DEUn3b</b> <b>DEUn4b</b> Menu items related to <b>alarm setup</b> . These will only appear if a relay board is detected. If so, please see Section 14.		
<b>An SET</b> <b>An Lo</b> <b>An Hi</b> or <b>An SET</b> <b>An Lo1</b> <b>An Hi1</b> <b>An Lo2</b> <b>An Hi2</b> Menu items related to <b>analog output</b> . These will only appear if a single or dual analog output board is detected. If so, please see Section 15.		
<b>SEr_1</b> <b>SEr_2</b> <b>SEr_3</b> <b>SEr_4</b> Menu items related to <b>serial communications</b> . These will only appear if an RS232 or RS485 I/O board is detected. If so, please see Section 16.		
Menu lockout items		
<b>Loc_1</b> <b>Loc_2</b> <b>Loc_3</b> <b>Loc_4</b> Menu items used to enable or lock out (hide) other menu items. <b>Loc</b> menu items may be locked out by a hardware jumper. Please see Section 9.		

\* See *Glossary* for explanation of item.

# 11. PROCESS RECEIVER & TOTALIZER SIGNAL CONDITIONER

This signal conditioner board converts 0-1 mA, 4-20 mA or 0-10 V analog process signals to a frequency signal, which is then read by the counter main board and processed mathematically for display of rate, total (time x rate), time based on rate, or batch control. The board needs to be configured via jumpers for the input signal range. The meter software recognizes the board and brings up the applicable menu items for it.

Please see further manual pages for the following features: relay output, analog output, serial communications, and transducer excitation output.

## JUMPER SETTINGS

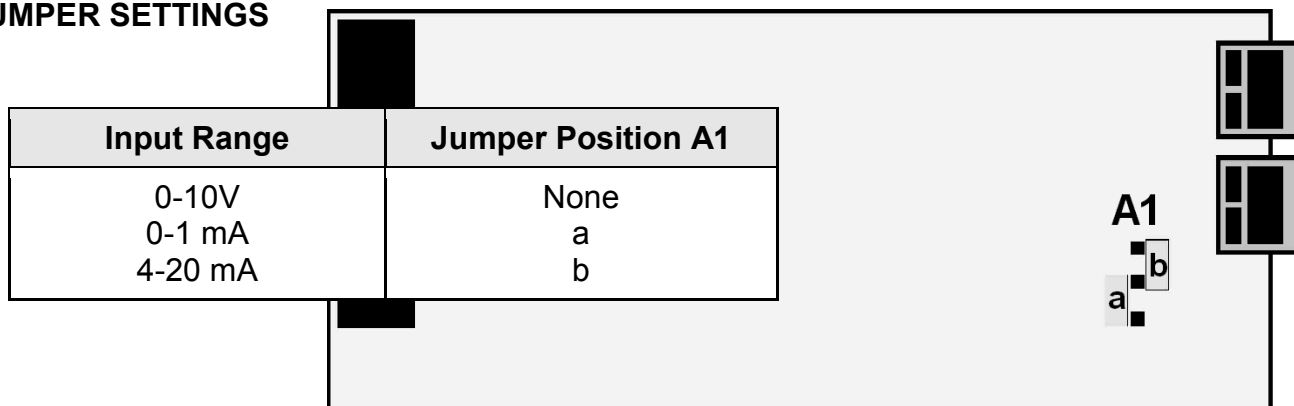

## OPERATING MODES

### RATE FROM A 4-20 mA OUTPUT FLOW METER

Dig. No.	S	1	2	3	4	5	6						
InPut		U	F	4	-	2	0	A		O	n	L	y
SEtUP			0	0	1		0						
ConFiG				1	0	0	0						
dSPyno						0	1						
GAte t			0	0	0.	2	2						
FILtEr			0	0	1	0	5						
DecPt1		1	1	1.	1	1	1						
Lo In1		0	4.	0	0	0	0						
Lo rd1		0	0	0.	0	0	0						
Hi In1		2	0.	0	0	0	0						
Hi rd1		0	0	5.	8	2	0						
CALib	-		0	0	0	0	0	Do Not Change Calib					

**Application:** Display rate in GPM to 3 decimal places from a 4-20 mA flow meter where 4 mA = 0 GPM and 20 mA = 5.820 GPM.

**Solution:** Set Input to “VF420 A only.” Under Setup, select the coordinates of 2 points scaling method. Under Config, select a display of 999999 and filtering. Set the decimal point to 3 places. For scaling, set Hi In1 to 20.0000 and Hi Rd1 to 5.820. Set Gate Time to 0.22 sec, which will provide noise averaging at a display update rate of 4/sec. Also set a 1.6 sec adaptive moving average filter to process the equivalent of 6 readings.

### RATE MODE (Basic Counter)

**Rate A** accepts 0-1 mA, 4-20 mA or 0-10 V analog process signals for a process display scaled to engineering units. Scaling is normally done using the coordinates of 2 points method, where low and high input signals and the corresponding desired low and high displayed values are entered. Scaling can also be done by entering scale and offset directly. With Scale1 set to 1 and Offset1 set to 0, the full analog input range is displayed as 0-100000. Measurements are averaged over a gate time, which is programmable from 10 ms to 199.99 sec. Selecting a long gate time provides a slower display update rate but superior

noise filtering. Moving average filtering is also available. Square root extraction is selectable for use with differential pressure flow transducers. Custom curve linearization is available with the Extended counter.

### RATE & TOTAL MODE (Basic Counter)

#### TOTAL FROM A 4-20 mA OUTPUT FLOW METER

**Application:** Display Total from a 4-20 mA flow meter where 4 mA = 0 and 20 mA = 5.820 GPM.

**Solution:** Set Input to “VF420 A A Total,” which displays Rate as Item #1 & Total as Item #2. Under dSPyno, select Item #2 to be displayed after meter reset. Set Gate Time to 0.1 sec to provide fast display updates with noise averaging. Set DecPt1 to 3 places for Rate and DecPt2 to 2 places for Total. Under Setup, select the coordinates of 2 points scaling method for Rate. Set Hi In1 to 20.0000 and Hi Rd1 to 5.820. You will need to use scale & offset to scale Total. Enter 1.66667 for Scale2 and a multiplier of 0.001. That is because totalizing sums rate readings every second. Since our rate is in units per minute, we have to divide by 60, then multiply by 0.1 for two decimal places. You may also enter a Cutoff such as 0.010 GPM, below which zero offset errors and negative values will not be totalized.

Dig. No.	S	1	2	3	4	5	6						
InPut		U	F	4	-	2	0	A		A	t	o	t
SEtuP			0	0	1		0						
ConFiG				1	1	0	0						
dSPyno						0	1						
CutoFF			0	0.	0	1	0						
GAtE t			0	0	0.	1	0						
FILtEr			0	0	1	0	3						
DecPt1		1	1	1.	1	1	1						
DecPt2		2	2	2	2.	2	2						
Lo In1		0	4.	0	0	0	0						
Lo rd1		0	0	0.	0	0	0						
Hi In1		2	0.	0	0	0	0						
Hi rd1		0	0	5.	8	2	0						
SCALE2		1.	6	6	6	6	7		0.	0	0	1	
OFFSt2		0	0	0	0.	0	0						
CALib	-		0	0	0	0	0	Do Not Change Calib					

**Rate A, Total A** allows rate to be displayed as Item #1 and total as Item #2. Scale2 and Offset2 apply to total. Total is calculated as the product of displayed rate and time in seconds. Since rate may be displayed in units per second, units per minute, units per hour or other units, the total must be scaled appropriately. If rate is in units per minute, multiply the total by 1/60. This is achieved by setting Scale2 to a scale factor of 1.66666 and a multiplier of 0.01. If rate is in units per hour, multiply the total by 1/3600. This is achieved by setting Scale2 to a scale factor of 2.77778 and a multiplier of 0.0001. If square root extraction or custom curve linearization (available with Extended counter) have been selected, totalizing will be of the linearized rate readings.

### BATCH CONTROL MODE (\_bAtCH) (Extended Counter)

**Batch control** uses the meter with a dual relay controller board to control repetitive fill operations. Relay #1 (or Setpoint #1) is used as the batch relay. Relay #2 (or Setpoint #2) can be assigned to another limit, such as pre-warn to slow filling near the setpoint, end-of-process, or rate alarm.

- **In batch control mode the meter displaying “Ready”,** the meter waits until the **RESET** key is pushed, it then energizes Relay #1 and displays the changing Batch Total starting at “Offset2”. When the setpoint 1 value is reached, Relay #1 de-energizes for the duration of the “time out” setting. Relay #1 then re-energizes, the Batch Total resets, and the fill cycle repeats.



- **In batch control mode with “external gate”**, the meter waits at the end of every cycle until an external gate input is grounded for a minimum of 3.33 ms. This starts a new fill cycle by energizing Relay #1 and resetting the Batch Total. *Gate time* is not used.

Three values are tracked and can be separately displayed by pressing the *RESET* key: Item #1, the Batch Total; Item #2, the Grand Total of all batches or Number of Batches (selectable during setup); and Item #3, the Fill Rate.

- **Item #1, Batch Total**, is the total of input pulses for that batch. It may be configured to count up from 0 to a preset, or to count down from a preset to 0. The preset value is placed in *ALARM1*. *SCALE1* is positive whether counting up or down.
- **Item #2, Grand Total**, is the sum of previous Batch Totals and the current Batch Total. It can overflow to exponential format.
- **Item #2 (alternate), Number of Batches**, is the current count of batches. *SCALE1* does not apply. *dECpt1* is set to 1.
- **Item #3, Fill Rate**, is calculated with a fixed 20 ms *gate time*. It may be displayed as Item #3.

**BATCH CONTROL WITH A 4-20 mA OUTPUT FLOW METER**



Dig. No.	S	1	2	3	4	5	6
InPut				r	A	t	E
SEtUP			1	0	0	1	0
ConFIG				1	1	0	0
dSPyno						0	1
CutoFF	0	0	0	0	0.		
GATe t			0	2	0.	0	0
bAtCH			1	0	0	1	0
FILtEr			0	0	1	0	5
SLOPE						0	0
DecPt1		1	1	1	1.	1	1
DecPt2		2	2	2	2.	2	2
SCALE1		1.	6	6	6	6	7
OFFSt1		0	0	5	5.	0	0
Lo In2		0	4.	0	0	0	0
Lo rd2		0	0	0	0.	0	0
Hi In2		2	0.	0	0	0	0
Hi rd2		0	0	3	9.	2	0
rESoLn							1
SourcE				1	1		
AL SET			0	0	2	4	0
dEUn1b		0	0	0	0.	0	0
dEUn2b		0	0	0	0.	0	0
CALib	-	0	0	0	0	0	0
Do Not Change Calib							
ALARM KEY	S	1	2	3	4	5	6
SETPT2		0	0	5	4.	0	0



**Application:** Fill 55 gallon tanks. Use a 4-20 mA flow meter where 4 mA = 0 and 20 mA = 39.20 GPM. Slow down filling at 54 gallons. Cycle batches automatically with 20 sec between cycles. Display batch total & fill rate to 2 places. Also track number of batches.

**Solution:** Use an Extended counter with a dual relay output board. Set Input to “Rate Batch.” Set Batch to count up to ALARM1, to use Gate Time as delay between batches, and to make Item #2 the number of batches. Set Gate Time to 20 sec. Set DecPt1 and DecPt 2 to two decimal places for Items #1 and #3 (Batch Total and Rate). Scale Item #3 (Rate) using the coordinates of 2 points method so that 20.0000 mA will be displayed as 39.20 GPM. Scale Item #1 (Batch Total) by entering a Scale1 of 1.66667 and a multiplier of 0.01. That is because totalizing sums readings in gallons every second. Since our rate is in GPM, we have to divide by 60. Enter an Offset1 of 55.00 to serve as the batch setpoint in gallons. Set Setpoint2 to 54.00 to activate Relay 2 to slow the fill rate.











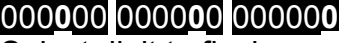

## KEYSTROKES FOR SETUP

If the **MENU**  key does not work, see Section 9 “Enabling & Locking Out Menu Items.” Menus are dynamic. Menu items will only appear if appropriate for previously made menu selections. For example, Batch menu items will only appear if “Batch” was selected under “Rate.” Extended counter items will only appear if “Extended” was selected under “Config.”

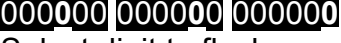
<b>MENU</b>  <b>Press Menu</b>	<b>PEAK</b>  <b>Press Digit Select Key</b>	<b>RESET</b>  <b>Press Value Select Key</b>	
<b>InPut</b> Input	<b>VF0-10</b> 0-10V full-scale input	<b>Basic</b>	<b>A_OnLy</b> Rate for Channel A (Item #1).
		<b>A_Atot</b> Rate for Channel A (Item #1). Total for Channel A (Item #2).	
	<b>VF4-20</b> 4-20 mA full-scale input	<b>Extended</b>	<b>bAtCH</b> Batch control mode. Batch total (Item #1). Grand total or number of batches (Item #2). Fill rate (Item #3).
		<b>VF 0-1</b> 0-1 mA full-scale input	<b>1/A</b> 1/Rate for Channel A (Item #1).
<b>SEtuP</b> Setup	<b>000 0</b> Stored totals	<b>0</b> Zero totals at power-on. <b>1</b> Restore totals at power-on.	
	<b>000 0</b> Leading zeros	<b>0</b> Blank leading zeros. <b>1</b> Display leading zeros.	
	<b>000 0</b> Scale factor 1 setup	<b>0</b> Input scale factor 1 and offset 1. <b>1</b> Use coordinates of 2 points method.	
	<b>000 0</b> Operation of rear connector inputs 1 & 2. <b>True</b> = logic 1 (0V or tied to digital ground). <b>False</b> = 0 (5V or open).	<b>0</b> 1 = Meter Reset*, 2 = Function Reset*	
		<b>1</b> 1 = Meter Reset*, 2 = Meter Hold*	
<b>2</b> 1 = Meter Reset*, 2 = Peak or Valley Display*			
<b>3</b> 1 = Meter Reset*, 2 = External Gate*			
<b>4</b> 1 = Function Reset*, 2 = Meter Hold*			
<b>5</b> 1 = Valley Only Display**, 2=Peak Only Display**			
<b>6</b> 1 = Function Reset*, 2 = External Gate*			
<b>7</b> 1 = Meter Hold**, Peak or Valley Display**			
<b>8</b> 1 = Reset Total A**, 2 = Reset Total B**			
<b>9</b> 1 = Force Alarm1, 2 = Force Alarm2			
<b>A</b> 1 = Meter Reset*, 2 = Display Blank*			
<b>B</b> 1 = Function Reset*, 2 = Display Blank*			
<b>C</b> 1 = Meter Hold*, 2 = Display Blank*			
<b>D</b> 1 = Peak or Valley Display**, 2 = Display Blank**			
<b>E</b> 1 = Display Blank, 2 = External Gate*			
<b>F</b> 1 = Display Item #2, 2 = Display Item #3 With 1 and 2 at 5V or open, Display Item #1.			
<p>* 1 &amp; 2 both at 0V = Meter Reset (can restore totals).</p> <p>** 1 &amp; 2 both at 0V for selections <b>5</b>, <b>7</b>, <b>8</b>, <b>D</b> = Function Reset* (erases all totals).</p>			

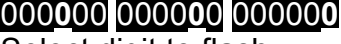
<b>MENU</b>  Press Menu	<b>PEAK</b>  Press Digit Select Key	<b>RESET</b>  Press Value Select Key
<b>ConFIG</b> Configura- tion	<b>0000</b> Display mode	<b>0</b> Normal, overload to exponential format <b>1</b> Normal, overload to 999999 <b>2</b> 1 right-hand dummy zero <b>3</b> 2 right-hand dummy zeros <b>4</b> Time display in seconds <b>5</b> Time display in HH.MM.SS format <b>6</b> Remote display (H, K, L commands) <b>7</b> Single-value remote display <b>8</b> Show 1 <sup>st</sup> string value, slaved to another meter <b>9</b> Show 2 <sup>nd</sup> string value, slaved to another meter <b>A</b> Show 3 <sup>rd</sup> string value, slaved to another meter <b>B</b> Show 4 <sup>th</sup> string value, slaved to another meter <b>C</b> Custom Start, Stop, Skip, Show
	<b>0000</b> Counter mode	<b>0</b> Basic counter <b>1</b> Extended counter <b>2</b> Extended counter, custom curve #1 selected <b>3</b> Extended counter, custom curve #2 selected
	<b>0000</b> Linearization mode	<b>0</b> Linear rate input. <b>1</b> Square root rate input.
	<b>0000</b> Rate cutoff enable for totalizing	<b>0</b> Do not totalize rate values below <b>CutoffFF</b> value. (avoids totalizing small offsets from 0 rate value or negative rate values). <b>1</b> Totalize all rates (required for bidirectional flow).
<b>dSPyno</b> Display #	<b>01</b> PEAK key action	<b>0</b> Display Peak <b>1</b> Display Valley <b>2</b> Peak (1 <sup>st</sup> push), Valley (2 <sup>nd</sup> push)
	<b>01</b> Item to display after Meter Reset*	<b>1</b> Item #1* <b>2</b> Item #2* <b>3</b> Item #3*
<b>CutoffFF</b> Totalizing cutoff*	<b>00000 00000 00000</b> <b>00000 00000</b> Select digit to flash.	Select <b>0</b> thru <b>9</b> for flashing digits. In A_Atot or Batch modes, meter will not totalize rate values below this cutoff to avoid totalizing small offsets from zero.
<b>GAte t</b> Gate time*	<b>000.00 000.00 000.00</b> <b>000.00 000.00</b> Select digit to flash.	Select <b>0</b> thru <b>9</b> for flashing digit to set gate time* in seconds. Decimal point location is fixed for 10 ms resolution. This is time over which rate is measured.
<b>ti_Out</b> Timeout*	<b>000.00 000.00 000.00</b> <b>000.00 000.00</b> Select digit to flash.	Select <b>0</b> thru <b>9</b> for flashing digit to set timeout* in seconds. Decimal point location is fixed for 10 ms resolution. This is time during which batch relay is de-energized at the end of a batch cycle.

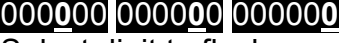
<b>MENU</b>  <b>Press Menu</b>	<b>PEAK</b>  <b>Press Digit Select Key</b>	<b>RESET</b>  <b>Press Value Select Key</b>
<b>bAtCH</b> Batch setup	<b>00000</b> & <b>00000</b>	<b>0</b> Not used with VF Batch. Set to 0.
	<b>00000</b> Batch triggering	<b>0</b> Use gate time* as delay between batches. <b>1</b> Use External Input B to start each new batch.
	<b>00000</b> Definition of Item #2	<b>0</b> Make Item #2 the Grand Total of all batches. <b>1</b> Make Item #2 the Total Number of batches.
	<b>00000</b> Action after Meter Reset	<b>0</b> Display "rEAdy." <b>RESET</b> key starts batching. <b>1</b> Start batching upon Meter Reset.
<b>FiLteR</b> Filtering	<b>00000</b> Signal filtering	<b>0</b> Adaptive moving average filter. Restarts filter for high actual changes in signal. <b>1</b> Conventional moving average filter without reset.
	<b>00000</b> Peak & Valley filtering	<b>0</b> Peak* or Valley* value from unfiltered signal. <b>1</b> Peak* or Valley* value from filtered signal.
	<b>00000</b> Display filtering	<b>0</b> Display value of unfiltered signal. <b>1</b> Display value of filtered signal.
	<b>00000</b> Adaptive filter setup	<b>0</b> Set adaptive filter for normal noise. <b>1</b> Set adaptive filter for presence of high transients.
	<b>00000</b> Filter time constant	<b>0</b> No filter <b>1</b> 0.1 sec <b>2</b> 0.2 sec <b>3</b> 0.4 sec <b>4</b> 0.8 sec <b>5</b> 1.6 sec <b>6</b> 3.2 sec <b>7</b> 6.4 sec
<b>dEC.Pt1</b> Decimal pt1	<b>1.11111</b> Decimal point flashes.	<b>1.11111 11.1111 111.111 1111.11 11111.1 111111.</b> Press <b>▲</b> to shift the decimal point.
<b>dEC.Pt2</b> Decimal pt2	<b>2.22222</b> Decimal point flashes.	<b>2.22222 22.2222 222.222 2222.22 22222.2 222222.</b> Press <b>▲</b> to shift the decimal point.
Scale and Offset scaling method if selected under <b>SEtuP</b>		
<b>SCALE1</b> Scale Factor 1	<b>0.00000 0.00000 0.00000</b> <b>0.00000 0.00000 0.00000</b> Select the digit to flash for the Scale Value, then press <b>▶</b> one more time for the Scale Multiplier.	Select <b>9</b> thru <b>9</b> for flashing first digit and <b>0</b> thru <b>9</b> for other flashing digits. This will set the Scale Value* from -9.99999 to 9.99999 with a fixed decimal point. Then press <b>▲</b> to select a value from <b>0.00001</b> to <b>100000</b> in decade steps for the Scale Multiplier. Scale Factor = Scale Value x Scale Multiplier.
<b>OFFSt1</b> Offset 1	<b>000000 000000 000000</b> <b>000000 000000 000000</b> Select digit to flash.	Select <b>9</b> thru <b>9</b> for flashing first digit and <b>0</b> thru <b>9</b> for other flashing digits. Use <b>dEC.Pt1</b> to set the decimal point.
<b>SCALE2</b>	Scale Factor 2.	Make the same Scale Factor 1.
<b>OFFSt2</b>	Offset 2.	Make the same as for Offset 1.

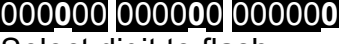
 <b>MENU</b> Press Menu	 <b>PEAK</b> Press Digit Select Key	 <b>RESET</b> Press Value Select Key
Coordinates of 2 points scaling method if selected under <b>SEtuP</b>		
<b>Lo_In1</b> Low signal input 1.	  Select digit to flash.	Select <b>9</b> thru <b>9</b> for flashing first digit and <b>0</b> thru <b>9</b> for other flashing digits. Move decimal point location when flashing.
<b>Lo_rd1</b> Reading at Lo In1.	  Select digit to flash.	Select <b>9</b> thru <b>9</b> for flashing first digit and <b>0</b> thru <b>9</b> for other flashing digits. Decimal point is fixed by <b>dEC.Pt1</b> .
<b>Hi_In2</b> High signal input 2.	  Select digit to flash.	Select <b>9</b> thru <b>9</b> for flashing first digit and <b>0</b> thru <b>9</b> for other flashing digits. Move decimal point location when flashing.
<b>Hi_rd2</b> Reading at Hi In2.	  Select digit to flash.	Select <b>9</b> thru <b>9</b> for flashing first digit and <b>0</b> thru <b>9</b> for other flashing digits. Decimal point is fixed by <b>dEC.Pt1</b> .
Special curve offset for square root or custom curve linearization if selected under <b>ConFiG</b>		
<b>rd0_In</b>	  Select digit to flash.	Select <b>9</b> thru <b>9</b> for flashing first digit and <b>0</b> thru <b>9</b> for other flashing digits. Decimal point is fixed by <b>dEC.Pt1</b> . Enter 04.000 for square root extraction with a 4-20 mA signal.
Scale multiplier		
<b>rESoLn</b> Resolution	Flashing 6-digit number in decade steps from <b>0.00001</b> to <b>100000</b>	Press <b>▲</b> to select. This multiplier <b>R</b> appears with the Batch mode and can be applied to Grand Total to set its decimal point.
Quartz crystal time base calibration		
<b>CALib</b>	Time base calibration.	Do not change. See Calibration section of manual.
Option dependent menu items		
<b>Source</b> <b>AL SEt</b> <b>AL S34</b> <b>dEU<sub>n</sub>1H</b> <b>dEU<sub>n</sub>2H</b> <b>dEU<sub>n</sub>1b</b> <b>dEU<sub>n</sub>2b</b> <b>dEU<sub>n</sub>3H</b> <b>DEUn4H</b> <b>DEUn3b</b> <b>DEUn4b</b> Menu items related to <b>alarm setup</b> . These will only appear if a relay board is detected. If so, please see Section 14.		
<b>An SEt</b> <b>An Lo</b> <b>An Hi</b> or <b>An SEt</b> <b>An Lo1</b> <b>An Hi1</b> <b>An Lo2</b> <b>An Hi2</b> Menu items related to <b>analog output</b> . These will only appear if a single or dual analog output board is detected. If so, please see Section 15.		
<b>Ser 1</b> <b>Ser 2</b> <b>Ser 3</b> <b>Ser 4</b> Menu items related to <b>serial communications</b> . These will only appear if an RS232 or RS485 I/O board is detected. If so, please see Section 16.		
Menu lockout items		
<b>Loc 1</b> <b>Loc 2</b> <b>Loc 3</b> <b>Loc 4</b> Menu items used to enable or lock out (hide) other menu items. <b>Loc</b> menu items may be locked out by a hardware jumper. Please see Section 9.		

## 12. QUADRATURE SIGNAL CONDITIONER

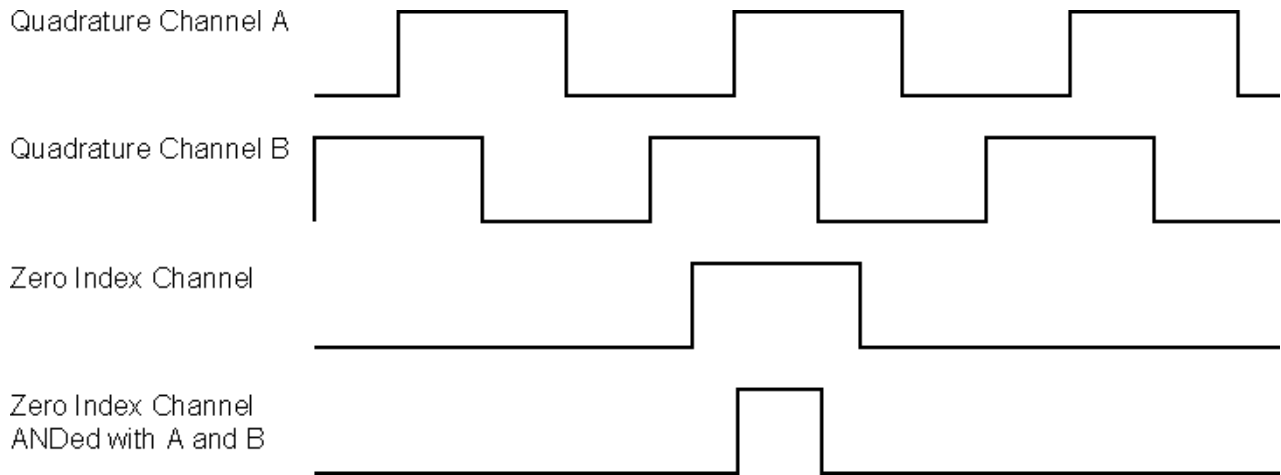

Our quadrature signal conditioner board can be used for quadrature position (with Basic or Extended main board) or for quadrature rate (with Extended main board). Two quadrature signals, which are 90° out of phase, are applied to the Channel A and B inputs. Their phase relationship determines whether the count is up (+) or down (-). A zero index signal may be applied to Channel Z as a position reference.

**Position in engineering units** is determined by adding or subtracting transitions, as determined by the signal phase relationship, applying a programmable scale factor to the total, and adding programmable OFFSET1 to the scaled total. The display update rate is set by a gate time, which is programmed to 10 ms. When the scaled total reaches a programmable Preset, it is reset to OFFSET1.

**Rate in engineering units** is determined by measuring Rate A and Rate B in transitions per second for Channels A and B, subtracting Rate B from Rate A, and applying a scale factor. Rate is measured over a gate time, which is programmable from 10 ms to 199.99 sec. Since one of the two channels may not be measuring any pulses over the gate time, a timeout from 10 ms to 199.99 sec is also programmable. The meter update rate will never be less than every timeout. Quadrature rate provides a high resolution, high accuracy display.

**A zero index function** is available on a separate zero index channel to reset the count to the expected count when a zero index pulse is detected. For example, if 3000 counts is expected after three 1000-count revolutions but the current count is 2998 when the zero index pulse is detected, the count is reset to 3000. Since a wide zero index pulse could cause a count discrepancy in the region between transitions, the zero index pulse can be shaped by an AND combination with the A or B channels, as set by jumpers. Please see the diagram at the top of this page, which shows an AND combination of the zero index channel, Channel A and Channel B.

**To zero the counts at a hard stop, use function reset.**

Please see further manual pages for the following features: relay output, analog output, serial communications, and transducer excitation output.

## Jumper Settings

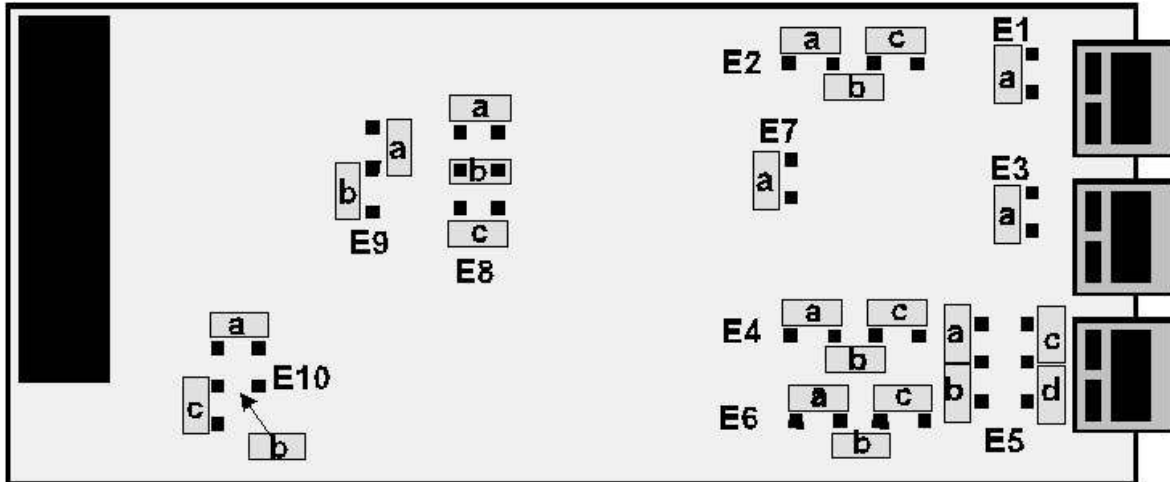

Note: Letters indicate jumper position. Jumpers are installed on pins adjacent to letters.

Input Type	E2	E4	E6	E5
Single-ended (signal & return)	a, c	a, c	a, c	c
Differential	b	b	b	c
Differential (with excitation and no zero index)	b	b	-	b, d
Input Termination (for differential inputs only)	E1	E3	E5	
For long cable runs	a	a	a	
For short cable runs	none	none	none	
Phase for Up Count	E7			
A positive, negative B transition (A leads B)	none			
A positive, positive B transition (B leads A)	a			
Count-by Options	E9			
X1 = positive edge of A input	none			
X2 = positive & negative edges of A input	a			
X4 = positive & negative edges of A & B inputs	b			
Zero Index Polarity	E8			
Positive	c			
Negative	none			
Zero Index ANDing	E10		E8	
Zero Index (no ANDing)	c		-	
Zero Index AND /A	a		-	
Zero Index AND /B	a		a	
Zero Index AND A	a		b	
Zero Index AND B	a		a, b	
Zero Index AND /A AND /B	b		-	
Zero Index AND /A AND B	b		a	
Zero Index AND A AND /B	b		b	
Zero Index AND A AND B	b		a, b	

## PRINCIPLE OF OPERATION

The quadrature decoder board generates up (+) and down (-) counts that are arithmetically totalized on the main counter board and are then displayed. The decoder board has input circuitry that may be jumpered for single-ended input signals or balanced line driver signals. It accepts normal A & B quadrature signals and, if present, a zero index signal. The A & B signals are 90° out of phase, and their phase relationship determine whether Up counts are added to the total, or Down counts are subtracted from the total.

Since incremental optical encoders may have a different A & B phase relationship to indicate up and down counting, the board has a jumper E7 (BPOL) on the B signal to allow selection of the desired phase. With the jumper not installed, Up output pulses are created when the B signal has a positive transition while the A signal is at a positive level (A leads B). With the jumper installed, Up output pulses are created when the B signal has a negative transition while the A signal is at a positive level (B leads A). With the opposite phase shown, the effect of E7 reverses.

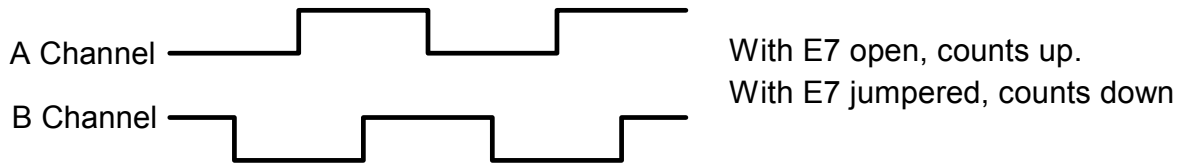

The board has jumpers that allow counting by 1, 2 or 4 counts per cycle of the A or B signals. The edges that are counted are:

- X1 = positive transitions of the A signal.
- X2 = positive and negative transitions of the A signal.
- X4 = positive and negative transitions of both the A and the B signals.

Digital filtering is provided for the A & B signals to reduce the probability of noise providing false counts.

Some optical encoders create a zero index signal once per revolution that indicates when the encoding wheel is at its zero position. Each time this signal is created, the total count should be a multiple of the number of counts per revolution of the coding wheel. If this feature is enabled in the counter, the counter checks to see if total counts are an exact multiple of the counts per revolution. If so, it does nothing, and if not, it changes the total to the closest exact multiple. The counts per revolution are entered into the counter via the menu item Pulses. From 0 to 59,999 pulses may be entered. If X2 or X4 counting is enabled on the board, the value entered into Pulses should be the counts (or pulses) per revolution of the encoder multiplied by this factor of X2 or X4. If Scale is a factor other than 1, include it as a multiplying factor when determining the value of Pulses to enter. Do not include the value of OFFSET1.

### Example:

If the encoder produces 256 cycles per revolution, X2 counting is selected by a jumper on the board and from the front panel Menu of the counter, SCALE1 is set to 3, and OFFSET1 is set to 100, then set PULSES =  $256 \times 2 \times 3 = 1536$  from the front panel menu.



The zero index channel has the same digital filtering as the A & B channels. It contains a Polarity jumper that allows selection of either a positive or negative zero index signal. It also contains two Control inputs, C1 and C2 that control the ANDing of the zero index signal with the Channel A and Channel B signals. See “Zero Index Setup” below.

The Item indicator light (center right) may be used to determine the location of the Zero Index. This indicator is lighted while the zero index signal is being received. The zero index signal must be jumpered for the correct polarity. If, during encoder motion, the indicator is on more than it is off, it is likely that the zero index signal is jumpered for the wrong polarity. If so, add a Polarity jumper to switch E8, position C. If it already has a jumper, remove it.

From the menu, a value may be entered for Offset1. As explained below under “Mechanical Zero”, OFFSET1 allows a mechanical zero position different from the zero index position. The displayed value is the sum of the following:

1. The total bidirectional counts from the optical encoder since the last counter reset or function reset.
2. The correction factor from the last zero index correction calculation.
3. OFFSET1

**Example:**

Suppose that the encoder contains 30 pulses per revolution and that X1 counting is used. Further suppose that when the mechanics are at their 0 position, the zero index is at 10, OFFSET 1 = 10, and the counter is reset when the encoder is at the 5 position.

	Reset						
	v						
Position	0	5	10	20	30	40	50
Index			^			^	
Internal Total →		0	5	15	25	35	45
Correction		0	-5	-5	-5	-5	-5
OFFSET		10	10	10	10	10	10
		----	----	----	----	----	----
Display		10	10	20	30	40	50
Internal Total ←	-5	0	5	15	25	35	45
Correction	-5	-5	-5	-5	-5	-5	-5
OFFSET	10	10	10	10	10	10	10
	----	----	----	----	----	----	----
Display	0	5	10	20	30	40	50

Once the index point has been passed, the display matches the position. Prior to that, the display is in error.

When the counter is displaying Quadrature Total and the Total is reset using the Reset & Peak buttons (Function Reset), the internal Total is set to zero, but the zero index correction is not affected. This results in a display of the correction value plus OFFSET1. To zero the internal Total and the correction value, the counter must be reset using the Reset & Menu buttons (Meter Reset). This results in a display of OFFSET1.

## ZERO INDEX SETUP

The relationship between the zero index correction signal and the Channel A & B signals varies by encoder model and by manufacturer. To accommodate this variation, the Quadrature board has control jumpers and selectable outputs that provide ANDing of the zero index signal with all possible combinations of the Channel A & B signals.

Consider a typical encoder model that produces the waveforms shown below. Assume that X4 counting is selected. The count increases or decreases with each A & B transition and remains steady between transitions. The counts shown below the waveforms represent the effect of the zero index correction ZI if no ANDing is used. Note the difference in count in the regions between transitions when counting up and then counting down. The zero index correction is made on the leading edge transition of the zero index signal. When counting down, the leading edge is the trailing edge of the signal shown below because time is increasing from right to left.

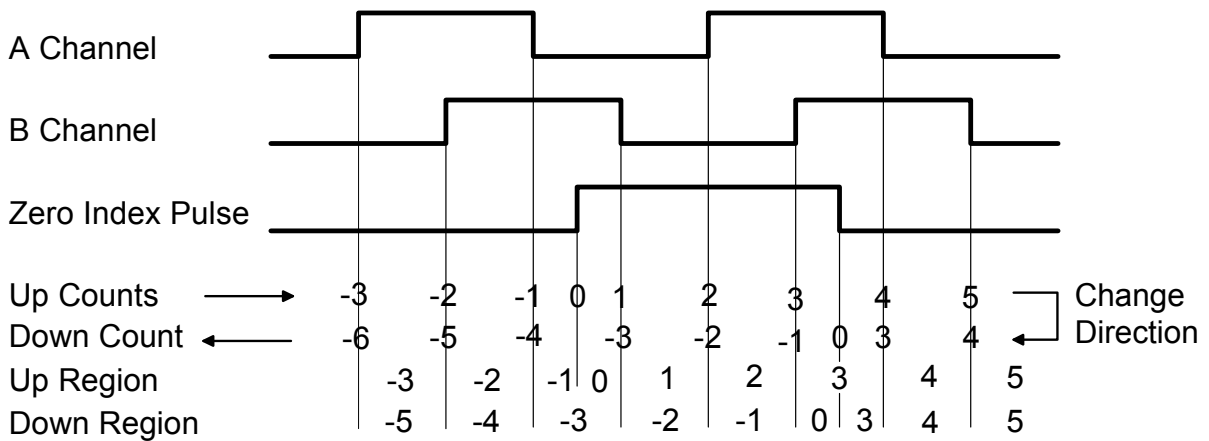

It follows that a wide zero index signal causes a discrepancy in the count in the regions between transitions when counting up and counting down. To correct this situation, AND the zero index signal with the A & B channel signals. Assume for this example the zero index is ANDed with the inverse of A ( $\bar{A}$ ) and the inverse of B ( $\bar{B}$ ) to produce ZIY as shown below.

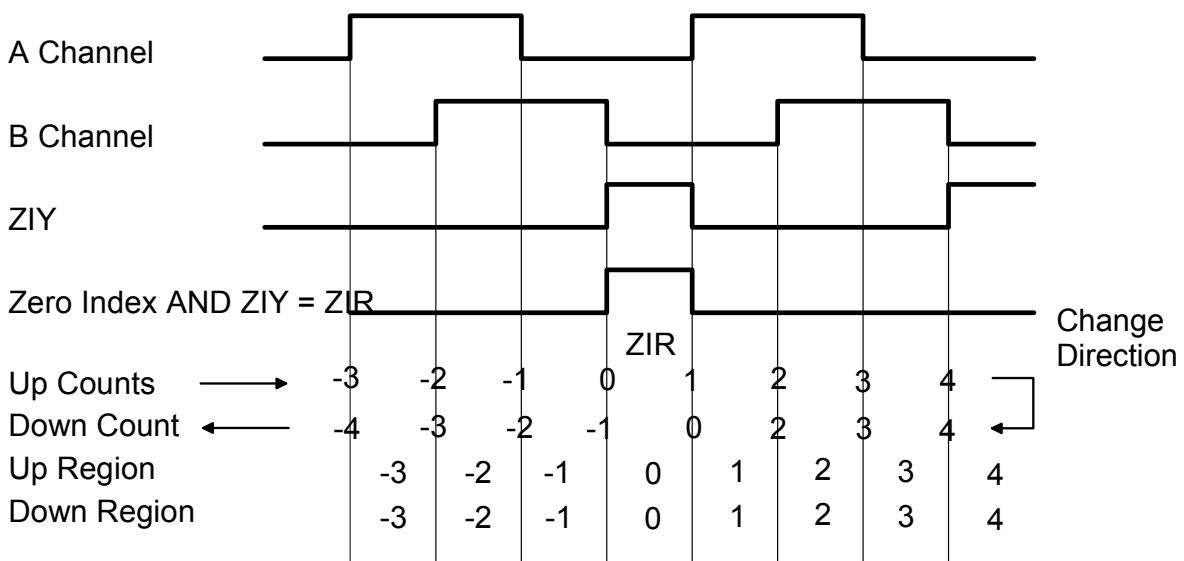

By ANDing the zero index signal with the A & B channels, there is no regional discrepancy between counting up and counting down.

There are 2 control signals, C1 and C2, and 3 outputs, ZI, ZIX and ZIY. These may be jumpered to provide 8 selections of ANDed signals or the zero index signal without ANDing.

Zero Index Polarity	Jumper Position	
	E8	
Positive	None	
Negative	c	

Zero Index ANDing	Jumper Position	
	E10	E8
Zero Index (no ANDing)	C	-
Zero Index AND /A	a	-
Zero Index AND /B	a	a
Zero Index AND A	a	b
Zero Index AND B	a	a, b
Zero Index AND /A AND /B	b	-
Zero Index AND /A AND B	b	a
Zero Index AND A AND /B	b	b
Zero Index AND A AND B	b	a, b

The manufacture's data sheet for the optical encoder will show the position and width of the zero index signal with respect to the A channel and B channel signals. Selection of one of the above combinations depends on that relationship and the polarity of the channel A & B signals when the mechanical position is zero. Be sure to take into account the selected phase relationship determined by the presence of or absence of jumper E7-a (BPOL). Jumper E7-a is selected to cause the display to count in the proper direction. If jumper E7 is in place, the channel B signal will have the opposite polarity from the channel B output of the encoder.

## MECHANICAL ZERO

By using the Counter's OFFSET1 value, it is possible to place the mechanical zero (zero counter reading) at some point other than the location of the zero index. The following technique describes how to accomplish this.

1. Set the E8 & E10 jumpers as described above to produce the desired Zero Index signal.
2. Set OFFSET1 = 0.
3. Reset the counter (counter reset).
4. Rotate the optical encoder in the positive direction until the reading jumps to zero at the zero index point (Item indicator lights).
5. Reverse the direction of rotation until the desired zero mechanical position is reached.
6. Note the reading and enter that reading into OFFSET1 using the opposite polarity of the display.
7. Reset the counter, and it will display the OFFSET1 value because the internal total counter = 0 and the correction = 0. The position of the encoder when the counter is reset is not critical.

8. Rotate the optical encoder past the zero index point to set the internal correction.
9. Return to the desired zero mechanical position and verify a zero reading.

This completes the procedure. If the encoder is rotated back to mechanical zero, it should read zero. Note: Any time the counter is powered up or reset, the optical encoder should be rotated past the zero index point one time to set the internal correction

If a zero index signal is not available from the encoder, perform the following procedure:

1. Remove any E10 jumpers to eliminate the Zero Index signal.
2. Set OFFSET1 = 0.
3. Adjust the optical encoder to the mechanical zero position and with it in this position, reset the counter.

## SETUP SUMMARY

1. Set the input signal jumpers.
  - A. For single-ended signals such as TTL or CMOS, use jumpers **c** of E2, E4 and E6 and jumper **a** of E6. Input signals are applied as follows:
    - Channel A, P5-1X (AH)
    - Channel B, P5-3Y (BH)
    - Channel Z, P5-5Z (ZH) Zero Index
    - Ground, P5-6Z
 If an excitation voltage is required, use jumper **a** of E2 and jumper **a** of E4.
  - B. For differential line driver or balanced input signals, use jumper **b** for E2, E4 and E6. If 120 ohm line termination resistors are desired, place jumpers E1, E3 and E5.
2. Set the correct counting direction by placing or omitting the Channel B polarity jumper E7.
3. Choose X1, X2 or X4 counting and omit **a** and **b** of E9 for X1, place **a** of E9 for X2 or place **b** of E9 for X4. Determine the scale factor to be used by the counter and set SCALE1 to this value using the counter Menu. Most often it will be set to 1.00000 with a multiplier of 1.
4. If the Zero Index is to be used, do the following:
  - A. Temporarily place jumper **c** of E10 and rotate the encoder while watching the Item indicator of the display. If it is OFF most of the time, the Z polarity is correct. If it is ON most of the time, the Z polarity is incorrect, so add jumper **c** of E8 if it is missing, or remove jumper **c** of E8 if it is in place.
  - B. From the manufacturer's specifications for the encoder showing the relationship of the Zero Index signal to the Channel A and Channel B signals, determine from the table above the desired positions of jumpers **a** and **b** of E8 and **a**, **b** or **c** of E10. If not used here, remove jumper **c** of E10 that was placed for the test in A. above.
  - C. From the manufacture's specifications for the encoder, determine the number of cycles per revolution. Multiply this by 1, 2, or 4 depending on the selection of X1, X2 or X4 counting and multiply that result by the counter scale factor. Put the final result in the counter Menu item, PULSES.
5. Follow the procedure outlined above under the heading MECHANICAL ZERO.

**WAVESHAVE EXAMPLES BY ENCODER MANUFACTURER**

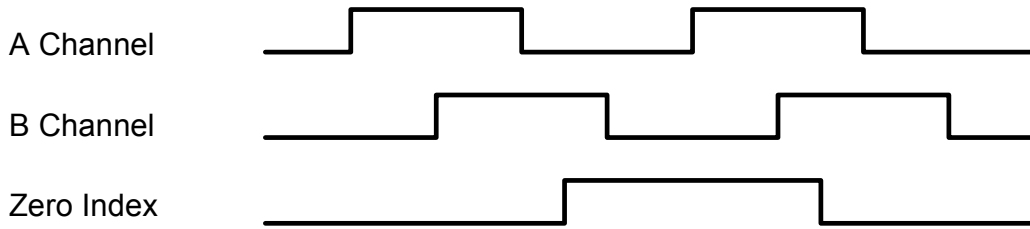

**Allen Bradley:** current sink, open collector & line driver, CCW rotation

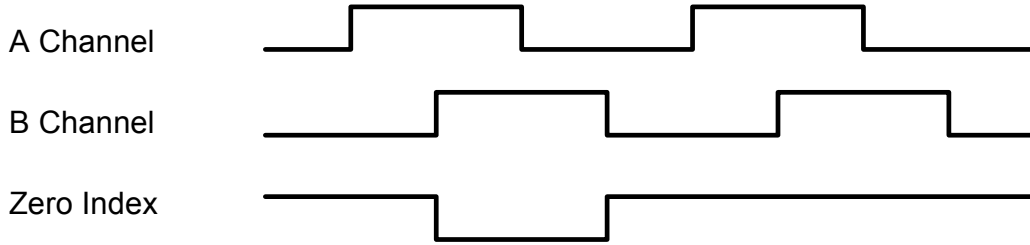

**Allen Bradley:** current source, CCW rotation.

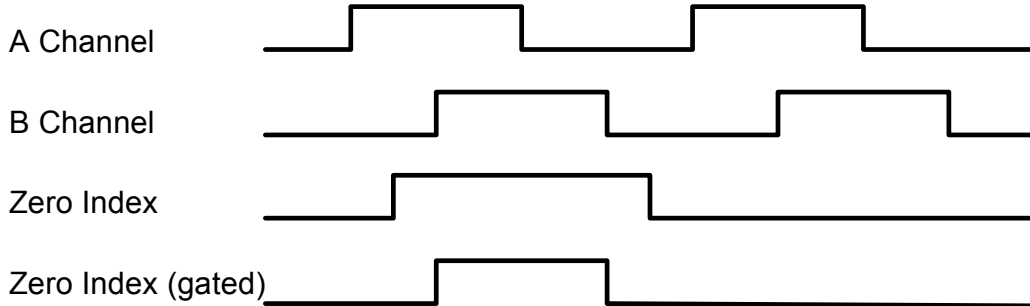

**BEI:** Models H25, L25, E25, MOD5500, MOD5600,CCW rotation

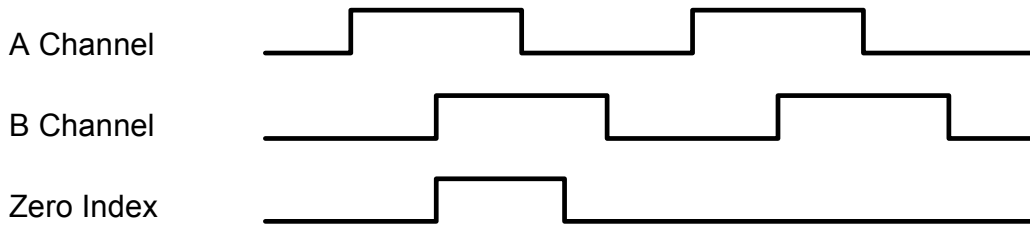

**BEI:** Models MX-51, MX-21,CCW rotation

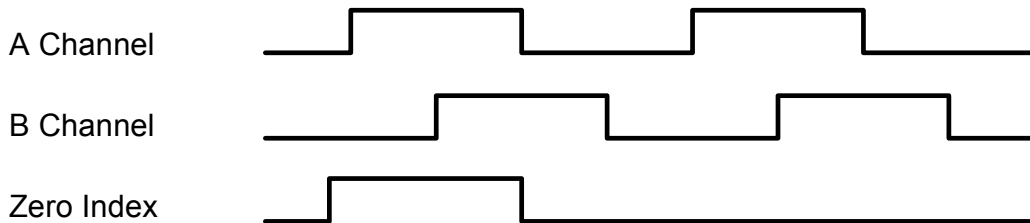

**BEI:** Models E20, E11, E15, CMX216, MOD900, CW rotation

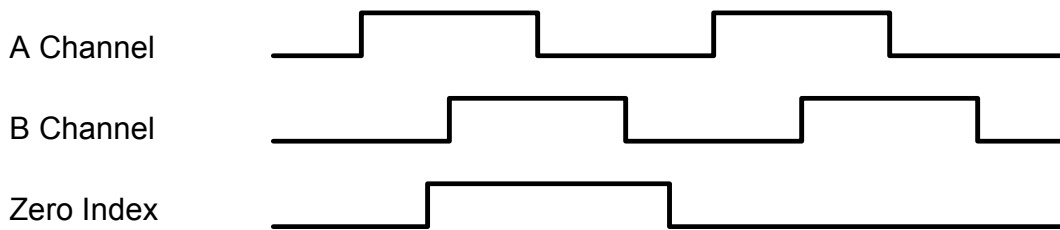

**Bourns: EN Series**

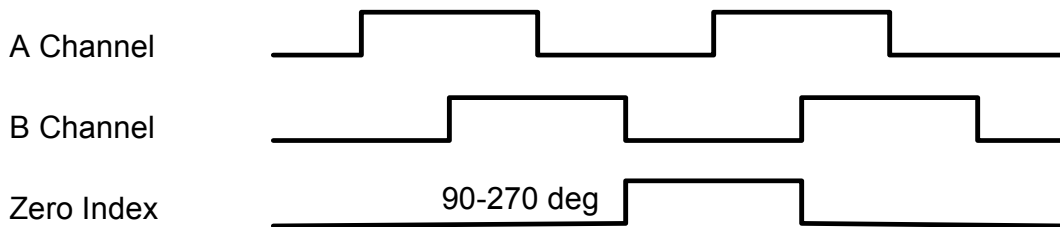

**Computer Optical Products**

Models CP-350, CP-360, CP-370, CP-850, CP870, CCW rotation.

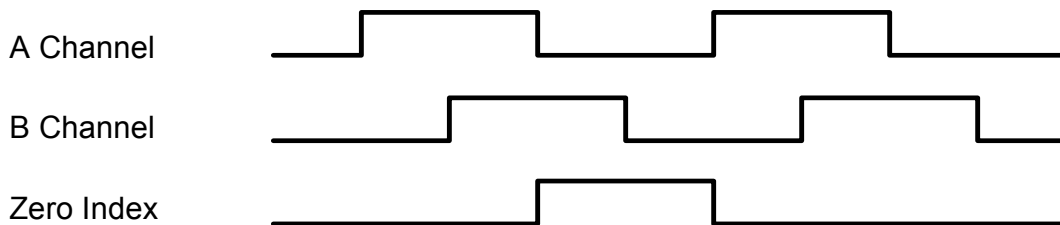

**Encoder Prod: Models H25, L25, E25, MOD5500, MOD5600, CCW rotation**

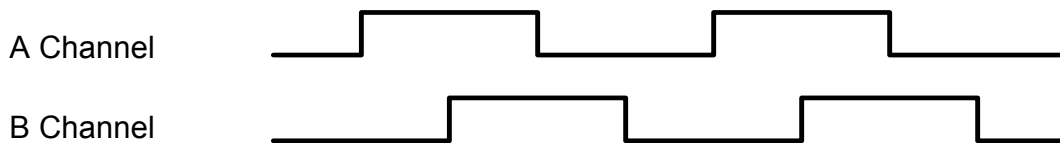

**Grayhill & Oak-Grigsby: CW rotation. No Zero Index.**

**QUADRATURE RATE**

Rate and direction may also be displayed using an extended version of the counter. Using quadrature to determine rate not only has the advantage of displaying direction but also eliminates errors due to vibration and jitter that cause erroneous readings in standard rate meters. The meter uses A-B to display quadrature rate. Scale 1 is used to set A to the proper value and scale 2 is set to identical values. Rate (I1) is the difference between Channel A and Channel B.

**PROGRAMMING EXAMPLE FOR QUADRATURE TOTAL:  
 DISPLAY DISTANCE TO 0.001 FT FROM A 1024 PULSE/REV QUADRATURE ENCODER**

Dig. No.	S	1	2	3	4	5	6
InPut			q	u	A	d	r
SEtUP			0	0	1	0	0
ConFIG				1	0	0	0
dSPyno						0	1
PULSES	0	1	0	2	4.		
GAte t			0	0	0.	0	1
DecPt1		1	1	1.	1	1	1
Lo In1		0	0	0	0	0	0
Lo rd1		0	0	0.	0	0	0
Hi In1		0	1	0	2	4.	0
Hi rd1		0	0	1.	7	8	2
CALib	-		0	0	0	0	0

**t o t A L**



Do Not Change Calib

**Application:** Display distance in feet with 3 decimal points using a 1024 pulse/revolution quadrature encoder tied to a roller with 1.782 ft circumference.

**Solution:** Set Input to “Quadrature Total.” Set Gate Time to 0.01 sec for fast display updates. Set DecPt1 to 3 places. Under Setup, select coordinates of 2 points scaling method. Set Hi In1 to 1024.0 (pulses) and the desired Hi Rd1 to 1.782 (feet).



**KEYSTROKES FOR SETUP OF QUADRATURE TOTAL**

If the *MENU*  key does not work, see Section 9 “Enabling & Locking Out Menu Items.”

 <b>Press Menu</b>	 <b>Press Digit Select Key</b>	 <b>Press Value Select Key</b>
<b>InPut</b> Input	<b>quAdr</b> Quadrature	Basic meter <b>totAL</b> Quadrature total (select for position) Extended <b>rAtE</b> Quadrature rate.
<b>SEtUP</b> Setup	<b>00000</b> Stored totals	<b>0</b> Zero all totals at power-on <b>1</b> Restore totals at power-on. Set <b>PULSES</b> to 0.
	<b>00000</b> Leading zeros	<b>0</b> Blank leading zeros. <b>1</b> Display leading zeros.
	<b>00000</b> Scaling method	<b>0</b> Input scale factor 1 and offset 1 <b>1</b> Use coordinates of 2 points method
	<b>00000</b> Not applicable	<b>0</b> Set to 0.
	<b>00000</b> Operation of rear connector inputs 1 & 2. <b>True</b> = logic 1 (0V or tied to digital ground). <b>False</b> = 0 (5V or open).	<b>0</b> 1 = Meter Reset*, 2 = Function Reset* <b>1</b> 1 = Meter Reset*, 2 = Meter Hold* <b>2</b> 1 = Meter Reset*, 2 = Peak or Valley Display* <b>3</b> 1 = Meter Reset*, 2 = External Gate* <b>4</b> 1 = Function Reset*, 2 = Meter Hold* <b>5</b> 1 = Valley Only Display**, 2=Peak Only Display** <b>6</b> 1 = Function Reset*, 2 = External Gate* <b>7</b> 1 = Meter Hold**, Peak or Valley Display** <b>8</b> 1 = Reset Total A**, 2 = Reset Total B** <b>9</b> 1 = Force Alarm1, 2 = Force Alarm2 <b>A</b> 1 = Meter Reset*, 2 = Display Blank* <b>B</b> 1 = Function Reset*, 2 = Display Blank* <b>C</b> 1 = Meter Hold*, 2 = Display Blank* <b>D</b> 1 = Peak or Valley Display**, 2 = Display Blank**

		<b>E</b> 1 = Display Blank, 2 = External Gate* <b>F</b> 1 = Display Item #2, 2 = Display Item #3 With 1 and 2 at 5V or open, Display Item #1. ----- * 1 & 2 both at 0V = Meter Reset (can restore totals). ** 1 & 2 both at 0V for selections <b>5</b> , <b>7</b> , <b>8</b> , <b>D</b> = Function Reset* (erases all totals).
<b>ConFIG</b> Configura- tion	<b>0000</b> Display mode	<b>0</b> Normal, overload to exponential format <b>1</b> Normal, overload to 999999 Normally select <b>1</b> , required for Preset function. See dual signal conditioner for other available modes.
	<b>0000</b> Counter type	<b>0</b> Basic counter (use for quadrature total) <b>1</b> Extended counter
	<b>0000</b> Square root	<b>0</b> Set to 0.
	<b>0000</b> V-to-F batch	<b>0</b> Set to 0.
<b>dSPyno</b> Display	<b>01</b> Response to PEAK pushbutton	<b>0</b> Peak <b>1</b> Valley <b>2</b> Peak (1 <sup>st</sup> push), Valley (2 <sup>nd</sup> push)
	<b>01</b> Item #	<b>1</b> Set to <b>1</b> (ignored for Quadrature Total).
<b>PULSES</b> Zero index pulses*	<b>00000 00000 00000</b> <b>00000 00000</b> Select digit to flash.	Select <b>0</b> thru <b>9</b> for flashing digit to set zero index pulses. This should pulses per revolution x edges per pulse (1, 2 or 4) x scale factor.
<b>GAtE t</b> Gate time*	<b>000.00 000.00 000.00</b> <b>000.00 000.00</b> Select digit to flash.	Select <b>0</b> thru <b>9</b> for flashing digit to set the display update rate from 10 ms to 199.99 s.
<b>dEC.Pt1</b> Decimal pt1	<b>1.11111</b> Decimal point flashes.	<b>1.11111 11.1111 111.111 1111.11 11111.1 111111.</b> Press <b>▲</b> to shift decimal point.
Scale and Offset scaling method if selected under <b>SEtuP</b>		
<b>SCALE1</b> Scale Factor 1	<b>0.00000 0.00000 0.00000</b> <b>0.00000 0.00000 0.00000</b> Select the digit to flash for the Scale Value, then press <b>▶</b> one more time for the Scale Multiplier.	Select <b>9</b> thru <b>9</b> for flashing first digit and <b>0</b> thru <b>9</b> for other flashing digits. This will set the Scale Value* from -9.99999 to 9.99999 with a fixed decimal point. Then press <b>▲</b> to select a value from <b>0.00001</b> to <b>100000</b> in decade steps for the Scale Multiplier. Scale Factor = Scale Value x Scale Multiplier.
<b>OFFSt1</b> Offset 1	<b>000000 000000 000000</b> <b>000000 000000 000000</b> Select digit to flash.	Select <b>9</b> thru <b>9</b> for flashing first digit and <b>0</b> thru <b>9</b> for other flashing digits. <b>dEC.Pt1</b> is used for decimal point.



 <b>MENU</b> Press Menu	 <b>PEAK</b> Press Digit Select Key	 <b>RESET</b> Press Value Select Key
Coordinates of 2 points scaling method if selected under <b>SEtUP</b>		
<b>Lo_In1</b> Low signal input 1.	<b>000000 000000 000000</b> <b>000000 000000 000000</b> Select digit to flash.	Select <b>9</b> thru <b>9</b> for flashing first digit and <b>0</b> thru <b>9</b> for other flashing digits. Move decimal point location when flashing.
<b>Lo_rd1</b> Reading at Lo In1.	<b>000000 000000 000000</b> <b>000000 000000 000000</b> Select digit to flash.	Select <b>9</b> thru <b>9</b> for flashing first digit and <b>0</b> thru <b>9</b> for other flashing digits. <b>dEC.Pt1</b> is used for decimal point.
<b>Hi_In1</b> High signal input 2.	<b>000000 000000 000000</b> <b>000000 000000 000000</b> Select digit to flash.	Select <b>9</b> thru <b>9</b> for flashing first digit and <b>0</b> thru <b>9</b> for other flashing digits. Move decimal point location when flashing.
<b>Hi_rd1</b> Reading at Hi In2.	<b>000000 000000 000000</b> <b>000000 000000 000000</b> Select digit to flash.	Select <b>9</b> thru <b>9</b> for flashing first digit and <b>0</b> thru <b>9</b> for other flashing digits. Decimal point is fixed by <b>dEC.Pt1</b> .
<b>PrESet</b> Preset*	<b>000000 000000 000000</b> <b>000000 000000 000000</b> Select digit to flash.	Select <b>9</b> thru <b>9</b> for flashing first digit and <b>0</b> thru <b>9</b> for other flashing digits. <b>dEC.Pt1</b> is used. When the meter counts up and reaches the Preset, it reverts to Offset1. When the meter counts down and reaches Offset1, it reverts to Preset. Set to 0 for no Preset.
<b>CALib</b>	Time base calibration	Not applicable to Total. Do not change value!
Option-dependent menu items		
<b>SourcE AL SEt AL S34 dEUUn1H dEUUn2H dEUUn1b dEUUn2b dEUUn3H DEUn4H DEUn3b DEUn4b</b> Menu items related to <b>alarm setup</b> These will only appear if a relay board is detected. If so, please see Section 14.		
<b>An SEt An Lo An Hi</b> or <b>An SEt An Lo1 An Hi1 An Lo2 An Hi2</b> Menu items related to <b>analog output</b> . These will only appear if a single or dual analog output board is detected. If so, please see Section 15.		
<b>SEr 1 SEr 2 SEr 3 SEr 4</b> Menu items related to <b>serial communications</b> . These will only appear if an RS232 or RS485 I/O board is detected. If so, please see Section 16.		
Menu lockout items		
<b>Loc 1 Loc 2 Loc 3 Loc 4</b> Menu items used to enable or lock out (hide) other menu items. <b>Loc</b> menu items may be locked out by a hardware jumper. Please see Section 9.		

\* See Glossary for explanation of item.

**PROGRAMMING EXAMPLE FOR QUADRATURE RATE:  
 DISPLAY RATE TO 0.001 FT/SEC FROM A 1024 PULSE/REV QUADRATURE ENCODER**

Dig. No.	S	1	2	3	4	5	6
InPut			q	u	A	d	r
SEtUP			0	0	1	1	0
ConFIG				1	1	0	0
dSPyno						0	1
GATe t			0	0	0.	2	2
ti Out			0	0	1.	0	0
FiLteR			0	0	0	1	0
DecPt1		1	1	1.	1	1	1
DecPt2		2	2	2.	2	2	2
Lo In1		0	0	0	0	0	0
Lo rd1		0	0	0.	0	0	0
Hi In1		0	1	0	2	4.	0
Hi rd1		0	0	1.	7	8	2
Lo In2		0	0	0	0	0	0
Lo rd2		0	0	0.	0	0	0
Hi In2		0	1	0	2	4.	0
Hi rd2		0	0	1.	7	8	2
rESoLn							1
CALib	-		0	0	0	0	0



Do Not Change Calib

**Application:** Display rate in feet/sec with 3 decimal points using a 1024 pulse/revolution quadrature encoder tied to a roller with 1.782 ft circumference. Have 4 display updates per second.

**Solution:** Set Input to “Quadrature Rate.” Set Gate Time to .22 sec so that the display update rate becomes .22 sec +30 ms +1 period. Set Time-out to 1 sec, so that pulse rates under 1 Hz are displayed as 0. Set both DecPt1 and DecPt2 to 3 places. Under Setup, select coordinates of 2 points scaling method. Set both Hi In1 and Hi In2 to 1024.0 (pulses/sec) and both the desired Hi Rd1 and Hi Rd2 to 1.782 (feet/sec). Note: the duplicate entries are required because the quadrature meter subtracts counterclockwise pulses from clockwise pulses.

## KEYSTROKES FOR SETUP OF QUADRATURE RATE

If the **MENU**  key does not work, see Section 9 “Enabling & Locking Out Menu Items.”

<b>MENU</b>  <b>Press Menu</b>	<b>PEAK</b>  <b>Press Digit Select Key</b>	<b>RESET</b>  <b>Press Value Select Key</b>
<b>InPut</b> Input	<b>quAdr</b> Quadrature	Basic meter <b>totAL</b> Quadrature total
		Extended <b>rAtE</b> Quadrature rate
<b>SEtuP</b> Setup	<b>00000</b> Not applicable	<b>0</b> Set to zero.
	<b>00000</b> Leading zeros	<b>0</b> Blank leading zeros. <b>1</b> Display leading zeros.
	<b>00000</b> Scaling Method 1	<b>0</b> Input scale factor 1 and offset 1 <b>1</b> Use coordinates of 2 points method
	<b>00000</b> Scaling Method 2	Make the same as Scaling Method 1
	<b>00000</b> Operation of rear connector inputs 1 & 2. <b>True</b> = logic 1 (0V or tied to digital ground). <b>False</b> = 0 (5V or open).	<b>0</b> 1 = Meter Reset*, 2 = Function Reset* <b>1</b> 1 = Meter Reset*, 2 = Meter Hold* <b>2</b> 1 = Meter Reset*, 2 = Peak or Valley Display* <b>3</b> 1 = Meter Reset*, 2 = External Gate* <b>4</b> 1 = Function Reset*, 2 = Meter Hold* <b>5</b> 1 = Valley Only Display**, 2=Peak Only Display** <b>6</b> 1 = Function Reset*, 2 = External Gate* <b>7</b> 1 = Meter Hold**, Peak or Valley Display** <b>8</b> 1 = Reset Total A**, 2 = Reset Total B** <b>9</b> 1 = Force Alarm1, 2 = Force Alarm2 <b>A</b> 1 = Meter Reset*, 2 = Display Blank* <b>B</b> 1 = Function Reset*, 2 = Display Blank* <b>C</b> 1 = Meter Hold*, 2 = Display Blank* <b>D</b> 1 = Peak or Valley Display**, 2 = Display Blank** <b>E</b> 1 = Display Blank, 2 = External Gate* <b>F</b> 1 = Display Item #2, 2 = Display Item #3 With 1 and 2 at 5V or open, Display Item #1.  ----- * 1 & 2 both at 0V = Meter Reset (can restore totals). ** 1 & 2 both at 0V for selections <b>5</b> , <b>7</b> , <b>8</b> , <b>D</b> = Function Reset* (erases all totals).
<b>ConFiG</b> Configura- tion	<b>0000</b> Display mode	<b>0</b> Normal, overload to exponential format <b>1</b> Normal, overload to 999999 Normally select <b>1</b> , required for Preset function. See dual signal conditioner for other available modes.
	<b>0000</b> Counter mode	<b>0</b> Basic counter <b>1</b> Extended counter (required for Quadrature Rate)
	<b>0000</b> Not applicable	<b>0</b> Set to 0.
	<b>0000</b> Not applicable	<b>0</b> Set to 0.

<b>MENU</b> <b>Press Menu</b>	<b>PEAK</b> <b>Press Digit Select Key</b>	<b>RESET</b> <b>Press Value Select Key</b>
<b>dSPyno</b> Display #	<b>01</b> PEAK key action	<b>0</b> Display Peak <b>1</b> Display Valley <b>2</b> Peak (1 <sup>st</sup> push), Valley (2 <sup>nd</sup> push)
	<b>01</b> Item to display after Meter Reset	<b>1</b> Item #1* (Quadrature Rate = Rate A - Rate B) <b>2</b> Item #2* (Rate A) <b>3</b> Item #3* (Rate B)
<b>GAtE t</b> Gate time*	<b>000.00 000.00 000.00</b> <b>000.00 000.00</b> Select digit to flash.	Select <b>0</b> thru <b>9</b> for flashing digit to set gate time* in seconds. Decimal point location is fixed for 10 ms resolution.
<b>ti_Out</b> Time-out*	<b>000.00 000.00 000.00</b> <b>000.00 000.00</b> Select digit to flash.	Select <b>0</b> thru <b>9</b> for flashing digit to set time-out* in seconds. Decimal point location is fixed for 10 ms resolution.
<b>FILtEr</b> Filtering	<b>00000</b> Signal filtering	<b>0</b> Adaptive moving average filter. Restarts filter for high actual changes in signal. <b>1</b> Conventional moving average filter without reset.
	<b>00000</b> Peak & Valley filtering	<b>0</b> Peak* or Valley* value from unfiltered signal. <b>1</b> Peak* or Valley* value from filtered signal.
	<b>00000</b> Display filtering	<b>0</b> Display value of unfiltered signal. <b>1</b> Display value of filtered signal.
	<b>00000</b> Adaptive filter setup	<b>0</b> Set adaptive filter for normal noise. <b>1</b> Set adaptive filter for presence of high transients.
	<b>00000</b> Filter time constant	<b>0</b> No filter <b>1</b> 0.1 sec <b>2</b> 0.2 sec <b>3</b> 0.4 sec <b>4</b> 0.8 sec <b>5</b> 1.6 sec <b>6</b> 3.2 sec <b>7</b> 6.4 sec
<b>dEC.Pt1</b> Decimal pt1	<b>1.11111</b> Decimal point flashes.	<b>1.11111 11.1111 111.111 1111.11 11111.1 111111.</b> Press  to shift decimal point of reading.
<b>dEC.Pt2</b> Decimal pt2	<b>2.22222</b> Decimal point flashes.	Make the same as <b>dEC.Pt1</b>
Scale and Offset scaling method if selected under <b>SEtUP</b>		
<b>SCALE1</b> Scale Factor 1	<b>0.00000 0.00000 0.00000</b> <b>0.00000 0.00000 0.00000</b> Select the digit to flash for the Scale Value, then press  one more time for the Scale Multiplier.	Select <b>9</b> thru <b>9</b> for flashing first digit and <b>0</b> thru <b>9</b> for other flashing digits. This will set the Scale Value* from -9.99999 to 9.99999 with a fixed decimal point. Then press  to select a value from <b>0.00001</b> to <b>100000</b> in decade steps for the Scale Multiplier. Scale Factor = Scale Value x Scale Multiplier.
<b>OFFSt1</b> Offset 1	<b>000000 000000 000000</b> <b>000000 000000 000000</b> Select digit to flash.	Select <b>9</b> thru <b>9</b> for flashing first digit and <b>0</b> thru <b>9</b> for other flashing digits. Use <b>dEC.Pt1</b> to set the decimal point.
<b>SCALE2</b>	Scale Factor 2	Make the same as <b>SCALE1</b> .
<b>OFFSt2</b>	Offset 2	Make the same as <b>OFFSt1</b> .

Coordinates of 2 points scaling method if selected under <b>SEtUP</b>		
<b>Lo_In1</b> Low signal input 1.	<b>000000 000000 000000</b> <b>000000 000000 000000</b> Select digit to flash.	Select <b>9</b> thru <b>9</b> for flashing first digit and <b>0</b> thru <b>9</b> for other flashing digits. Move decimal point location when flashing.
<b>Lo_rd1</b> Reading at Lo In1.	<b>000000 000000 000000</b> <b>000000 000000 000000</b> Select digit to flash.	Select <b>9</b> thru <b>9</b> for flashing first digit and <b>0</b> thru <b>9</b> for other flashing digits. Decimal point is fixed by <b>dEC.Pt1</b> .
<b>Hi_In1</b> High signal input 1.	<b>000000 000000 000000</b> <b>000000 000000 000000</b> Select digit to flash.	Select <b>9</b> thru <b>9</b> for flashing first digit and <b>0</b> thru <b>9</b> for other flashing digits. Move decimal point location when flashing.
<b>Hi_rd1</b> Reading at Hi In1.	<b>000000 000000 000000</b> <b>000000 000000 000000</b> Select digit to flash.	Select <b>9</b> thru <b>9</b> for flashing first digit and <b>0</b> thru <b>9</b> for other flashing digits. Decimal point is fixed by <b>dEC.Pt1</b> .
<b>Lo_In2</b>	Low signal input 2.	Make the same as <b>Lo_In1</b>
<b>Lo_rd2</b>	Reading at Lo In2	Make the same as <b>Lo_rd1</b>
<b>Hi_In2</b>	High signal input 2	Make the same as <b>Hi_In1</b>
<b>Hi_rd2</b>	Reading at Hi In2.	Make the same as <b>Hi_rd1</b>
Other setup parameters		
<b>rESoLn</b> Reading multiplier	Flashing 6-digit number in decade steps from <b>0.00001</b> to <b>100000</b>	Press <b>▲</b> to select a decade multiplier <b>R</b> for the rate reading. Set to 1.
<b>CALib</b>	Time base calibration	Do not change. See Calibration section of manual.
Option dependent menu items		
<b>SourceE AL SET AL S34 dEUn1H dEUn2H dEUn1b dEUn2b dEUn3H DEUn4H DEUn3b DEUn4b</b> Menu items related to <b>alarm setup</b> These will only appear if a relay board is detected. If so, please see Section 15.		
<b>An_SEt An_Lo An_Hi</b> or <b>An_SEt An_Lo1 An_Hi1 An_Lo2 An_Hi2</b> Menu items related to <b>analog output</b> . These will only appear if a single or dual analog output board is detected. If so, please see Section 15.		
<b>SEr_1 SEr_2 SEr_3 SEr_4</b> Menu items related to <b>serial communications</b> if a serial board is detected. If so, please see Section 16.		
Menu lockout items		
<b>Loc_1 Loc_2 Loc_3 Loc_4</b> Menu items used to enable or lock out (hide) other menu items. <b>Loc</b> menu items may be locked out by a hardware jumper. Please see Section 9.		

## 13. SERIAL INPUT METER / REMOTE DISPLAY OPERATION

With a Basic counter main board and a serial interface board, the counter can operate as a 6-digit serial input meter (or remote display) to display serial data received from a computer or PLC, or act as a slave display to another meter, counter or timer with a serial output. A signal conditioner board is not required, but will not interfere with remote display operation if installed.

The **serial I/O interface** can be provided by any of the following:

- **RS232 board:** single RJ11 connector for point-to-point communications.
- **USB Board:** Single standard USB connector for point-to-point communications.
- **USB-to-RS485 board:** Single standard USB connector and 1 RJ11 connector for multipoint communications.
- **RS485 board:** two RJ11 connectors in parallel for multipoint communications with 2-wire (half duplex) or 4-wire (full duplex) connection.
- **Modbus RS485 board:** two RJ45 connectors in parallel for multipoint communications with 2-wire (half duplex) or 4-wire (full duplex) connection.
- **Ethernet board:** RJ45 connector for standard Ethernet cable.

**Slave display operation** to the RS232 output of another meter requires that the jumper **h** be installed on the RS232 board of the slave meter. Also required is a **reversing phone cable**, where the wire colors of the two connectors are reversed from left to right. For more information, please see the Serial Communications Options Section 16 of this manual or the Jumper Settings sections of the *Custom ASCII Protocol Serial Communications Manual*.

**With an optional dual or quad relay output board** (contact or solid state relays), the serial input meter can provide remote alarm or control capability. The meter can be programmed so that the relays respond to the displayed reading or to received control characters. For setup information, please see the Dual & Quad Relay Output Options Section 14 of this manual.

**With an optional single or dual analog output board**, the serial input meter can provide isolated, scalable 4-20 mA, 0-20 mA, 0-10V or -10 to +10V analog outputs which track the displayed reading, thereby serving as a serial-to-analog converter. For setup information, please see the Analog Output Option Section 15 of this manual.

**Front panel setup** required for serial input meter (or remote display) operation is shown on the next page. Two items require special explanation:





- The first digit under **ConFig** item should be set to a value **6** thru **C**. If no signal conditioner board is detected, the meter defaults to setting **6**, where H, L, K commands are enabled. **H** means display the remote data only. **K** means that the received value is stored as Item #3, to become the source for alarm comparisons and analog output. **L** means both **H** and **K**. In slave mode, the remote meter can display any item of up to four data Items (or string values), such as the Sum of Rates A & B (Item #1), Rate A (Item #2), or Rate B (Item #3).
- A timeout **ti\_Out** can be set to a value from 10 ms to 199.99 sec. This is how long a serial reading will be displayed in the absence of a new serial input. If timeout is set to 0, the display will persist indefinitely in the absence of a new input.

**Additional programmable features** of the serial input meter are detailed in the “Command Mode for Remote Display Operation of Counter / Timer” and “Data Formats” sections of the *Custom ASCII Protocol Serial Communications Manual*. In particular, Mode 12 (hex C), which is invoked by setting the first digit under *ConFIG* to *C*, allows extraction of data from an ASCII string that contains multiple data values or non-numeric characters. This mode can accommodate selected Start and Stop characters. Any number of characters between the Start character and the data can be masked OFF. Up to 8 display characters (including sign and decimal point) can be masked ON. Any number of characters between the last displayed character and the Stop character can be masked OFF.

*Instrument Setup* software is required to set up parameters for the Remote Display in Mode 12 (hex C). This software is downloadable from our website.

### SELECTED FRONT PANEL SETUP ITEMS FOR SERIAL INPUT METER (not consecutive)

If the *MENU*  key does not work, see Section 9 “Enabling & Locking Out Menu Items.”

 <b>MENU</b> Press  Menu	 <b>PEAK</b> Press Digit  Select Key	 <b>RESET</b> Press Value Select Key
<b>SEtuP</b> Setup	<u>000_0</u> Control inputs 1 and 2	<b>F</b> 1 = Tare enable, 2 = Tare Control input 1 must be at 0V or grounded for Tare to operate.
<b>ConFIG</b> Configu- ration	<u>0000</u> Display mode	<b>6</b> Remote display (H, K, L commands) <b>7</b> Single-value remote display <b>8</b> Show 1 <sup>st</sup> string value, slaved to another meter <b>9</b> Show 2 <sup>nd</sup> string value, slaved to another meter <b>A</b> Show 3 <sup>rd</sup> string value, slaved to another meter <b>B</b> Show 4 <sup>th</sup> string value, slaved to another meter <b>C</b> Custom Start, Stop, Skip, Show characters
<b>ti_Out</b> Time-out	<u>000.00</u> <u>000.00</u> <u>000.00</u> <u>000.00</u> <u>000.00</u> Select digit to flash.	Select <b>0</b> thru <b>9</b> for flashing digit to set time-out in seconds. Decimal point location is fixed for 10 ms resolution.
<b>SER 1</b>	<u>000</u> Baud rate Fixed parameters: No parity, 8 data bits, 1 stop bit	<b>0</b> 300 baud <b>1</b> 600 baud <b>2</b> 1200 baud <b>3</b> 2400 baud <b>4</b> 4800 baud <b>5</b> 9600 baud <b>6</b> 19200 baud
<b>SER 2</b>	<u>0000</u> Meter address	Select <b>0</b> thru <b>F</b> for addresses 1 thru 15. Select <b>0.</b> thru <b>F.</b> (with decimal point) for addresses 16 thru 31.
<b>SER 3</b>	<u>00000</u> RS485	<b>0</b> Full duplex <b>1</b> Half duplex
<b>SER 4</b>	<u>000</u> Serial protocol	<b>0</b> Custom ASCII <b>1</b> Modbus RTU <b>2</b> Modbus ASCII
	<u>000</u> Parity	<b>0</b> None <b>1</b> Odd <b>2</b> Even
<b>Addr</b>	<u>000</u> <u>000</u> <u>000</u> Modbus address	<b>158</b> Select <b>0</b> through <b>9</b> for flashing digit. Address range is 1 to 247.

## 14. DUAL & QUAD RELAY OUTPUT OPTIONS

An optional relay board may be installed in the meter main board at plug position P2, adjacent to the power supply board. Four board versions are available: 2 or 4 relays, contact or solid state. Once installed, the relay board is recognized by the meter software or PC-based Instrument Set-up software, which will bring up the appropriate menu items for the type of board. These menu items will not be brought up if a relay board is not detected. Menu selections for relays 3 and 4 will not be brought up if the dual relay board is detected. All relay boards offer a choice of operating modes: normally off or on, latched or non-latched, hysteresis band, deviation band, alarm based on filtered or unfiltered signal, and selectable number of readings in alarm zone for alarm. The source compared to the setpoint may be the displayed item or a non-displayed item. Please see the Glossary at the end of this manual for an explanation of special terms.



### VIEWING & CHANGING SETPOINTS





The (Alarms) key can be used to step through and view setpoints while the meter continues to make conversions and performs setpoint control. If the (Peak) key is pressed while a setpoint is displayed, conversion stops and the setpoint can be changed. After pressing , you have 30 seconds, or the meter reverts to the normal display. To view setpoints, menu item Loc4, digit 4, must have been set to 0. To change setpoints, menu item Loc2, digit 6, must have been set to 0.

<b>Press Alarms Key</b>	<b>Press Digit Select Key</b>	<b>Press Value Select Key</b>
<b>3950.00</b> Press  (Alarms) to display Alarm 1 setpoint.	<b>3950.00</b> Current setpoint 1 value blinks, and Alarm 1 LED indicator lights. Press  to select a digit, which will blink.	<b>3050.00</b> To change setpoint 1 value, press  to change selected blinking digits.
<b>3950.00</b> Press  (Alarms) to display Alarm 2 setpoint.	<b>3950.00</b> Current setpoint 2 value blinks, and Alarm 2 LED indicator lights. Press  to select a digit, which will blink.	<b>3050.00</b> To change setpoint 2 value, press  to change selected blinking digits.
<b>3950.00</b> Press  (Alarms) to display Alarm 3 setpoint.	<b>3950.00</b> Current setpoint 3 value blinks, and Alarm 3 LED indicator lights. Press  to select a digit, which will blink.	<b>3050.00</b> To change setpoint 3 value, press  to change selected blinking digits.
<b>3950.00</b> Press  (Alarms) to display Alarm 4 setpoint.	<b>3950.00</b> Current setpoint 4 value blinks, and Alarm 4 LED indicator lights. Press  to select a digit, which will blink.	<b>3050.00</b> To change setpoint 4 value, press  to change selected blinking digits.
<b>3000.24</b> Press  (Alarms) again. Meter will reset and display the current reading.		



## KEYSTROKES FOR SETUP

If the **MENU**  key does not work, see Section 9 “Enabling & Locking Out Menu Items.”

<b>MENU</b>  <b>Press Menu</b>	<b>PEAK</b>  <b>Press Digit Select Key</b>	<b>RESET</b>  <b>Press Value Select Key</b>
<b>SourceE</b> Source to compare to setpoint	<b>0000</b> Setpoint 1 compared to:	<b>1</b> Filtered item <b>1</b> Item #1 <b>2</b> Item #2 <b>3</b> Item #3
	<b>0000</b> Setpoint 2 compared to:	<b>1</b> Filtered item <b>1</b> Item #1 <b>2</b> Item #2 <b>3</b> Item #3
	<b>0000</b> Setpoint 3 compared to:	<b>1</b> Filtered item <b>1</b> Item #1 <b>2</b> Item #2 <b>3</b> Item #3
	<b>0000</b> Setpoint 4 compared to:	<b>1</b> Filtered item <b>1</b> Item #1 <b>2</b> Item #2 <b>3</b> Item #3
<b>AL SEt</b> Alarm Setup for relays 1 & 2 if detected.  Press  until <b>ALSEt</b> is displayed.	<b>00000</b> Relay alarm state when alarm is active	<b>0</b> Relay 1 active on Relay 2 active on <b>1</b> Relay 1 active off Relay 2 active on <b>2</b> Relay 1 active on Relay 2 active off <b>3</b> Relay 1 active off Relay 2 active off
	<b>00000</b> Alarm latching or non-latching (auto reset) (see Glossary)	<b>0</b> AL1 non-latching AL2 non-latching <b>1</b> AL1 latching AL2 non-latching <b>2</b> AL1 non-latching AL2 latching <b>3</b> AL1 latching AL2 latching
	<b>00000</b> Alarm operates at and above setpoint (active high) or at and below setpoint (active low). (see Glossary)	<b>0</b> AL1 active high AL2 active high <b>1</b> AL1 active low AL2 active high <b>2</b> AL1 disabled AL2 active high <b>3</b> AL1 active high AL2 active low <b>4</b> AL1 active low AL2 active low <b>5</b> AL1 disabled AL2 active low <b>6</b> AL1 active high AL2 disabled <b>7</b> AL1 active low AL2 disabled <b>8</b> AL1 disabled AL2 disabled
	<b>00000</b> Hysteresis mode or band deviation mode (see Glossary)	<b>0</b> AL1 band deviation AL2 band deviation <b>1</b> AL1 hysteresis AL2 band deviation <b>2</b> AL1 band deviation AL2 hysteresis <b>3</b> AL1 hysteresis AL2 hysteresis <b>4</b> No deviation or hysteresis on menu <b>5</b> AL1 span hysteresis AL2 band deviation <b>6</b> AL1 span hysteresis AL2 hysteresis <b>7</b> AL1 span hysteresis AL2 span hysteresis
	<b>00000</b> Number of consecutive readings in alarm zone to cause an alarm	<b>0</b> After 1 reading <b>1</b> After 2 readings <b>2</b> After 4 readings <b>3</b> After 8 readings <b>4</b> After 16 readings <b>5</b> After 32 readings <b>6</b> After 64 readings <b>7</b> After 128 readings

<b>MENU</b> <b>Press Menu</b>	<b>PEAK</b> <b>Press Digit Select Key</b>	<b>RESET</b> <b>Press Value Select Key</b>
<b>ALS 34</b> Alarm Setup for relays 3 & 4 if detected.	<b>00000</b> Relay alarm state when alarm is active.	<b>0</b> Relay 3 active on      Relay 4 active on <b>1</b> Relay 3 active off      Relay 4 active on <b>2</b> Relay 3 active on      Relay 4 active off <b>3</b> Relay 3 active off      Relay 4 active off
	<b>00000</b> Alarm latching or non-latching (auto reset). (see Glossary)	<b>0</b> AL3 non-latching      AL4 non-latching <b>1</b> AL3 latching      AL4 non-latching <b>2</b> AL3 non-latching      AL4 latching <b>3</b> AL3 latching      AL4 latching
	<b>00000</b> Alarm operates at and above setpoint (active high) or at and below setpoint (active low). (see Glossary)	<b>0</b> AL3 active high      AL4 active high <b>1</b> AL3 active low      AL4 active high <b>2</b> AL3 disabled      AL4 active high <b>3</b> AL3 active high      AL4 active low <b>4</b> AL3 active low      AL4 active low <b>5</b> AL3 disabled      AL4 active low <b>6</b> AL3 active high      AL4 disabled <b>7</b> AL3 active low      AL4 disabled <b>8</b> AL3 disabled      AL4 disabled
	<b>00000</b> Hysteresis mode or band deviation mode (see Glossary)	<b>0</b> AL3 band deviation      AL4 band deviation <b>1</b> AL3 hysteresis      AL4 band deviation <b>2</b> AL3 band deviation      AL4 split hysteresis <b>3</b> AL3 hysteresis      AL4 hysteresis
	<b>00000</b> Number of consecutive readings in alarm zone to cause an alarm.	<b>0</b> After 1 reading <b>4</b> After 16 readings <b>1</b> After 2 readings <b>5</b> After 32 readings <b>2</b> After 4 readings <b>6</b> After 64 readings <b>3</b> After 8 readings <b>7</b> After 128 readings

<b>MENU</b> <b>Press Menu</b>	<b>PEAK</b> <b>Press Digit Select Key</b>	<b>RESET</b> <b>Press Value Select Key</b>
<b>dEUn1H</b> Alarm 1 hysteresis	<b>0.00000</b> <b>0.00000</b> <b>0.00000</b>	Select <b>9</b> thru <b>9</b> for flashing first digit, <b>0</b> thru <b>9</b> for other flashing digits. Alarms will activate above the setpoint by the value entered and deactivate below the setpoint by the value entered. For span hysteresis, the alarms will activate (deactivate) at the setpoint and deactivate (activate). See Glossary.
<b>DEUn2H</b> Alarm 2 hysteresis	<b>0.00000</b> <b>0.00000</b> <b>0.00000</b>	
<b>DEUn1b</b> Alarm 1 band deviation	Select digit to flash	
<b>DEUn2b</b> Alarm 2 band deviation		
<b>dEUn1h</b> Alarm 1 span hysteresis		
<b>DEUn2h</b> Alarm 2 span hysteresis		
<b>dEUn3H</b> Alarm 3 hysteresis		
<b>DEUn4H</b> Alarm 4 hysteresis		
<b>DEUn3b</b> Alarm 3 band deviation		
<b>DEUn4b</b> Alarm 4 band deviation		

## 15. SINGLE & DUAL ANALOG OUTPUT OPTIONS

Two versions of an analog board may be installed in the meter at rear panel jack position J4, adjacent to the signal conditioner board. Once installed, this board is recognized by the meter, which will bring up the appropriate menu items for it. These will not be brought up if an analog output board is not installed.

**A single analog output version** can be configured for unipolar 4-20 mA current, 0-20 mA current or 0-10V voltage, or bipolar -10 to +10V voltage (with a 20V voltage swing). Unipolar or bipolar operation is selected by a jumper.

**A dual analog output version** can be configured for two unipolar outputs, which can each be 4-20 mA, 0-20 mA or 0-10V. Current or voltage output is selected at each connector.

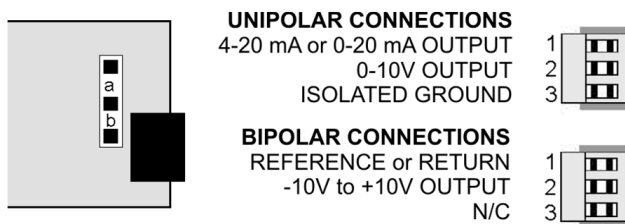

Unipolar current or voltage: Jumper **a**  
 Bipolar -10 to +10 voltage: Jumper **b**

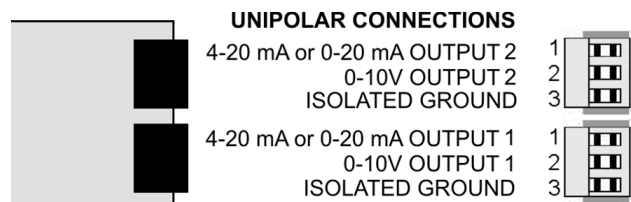

No jumpers, only selections at the connectors.

**With either board**, current or voltage output is selected at the connector and in the Menu. The low analog output (0 mA, 4 mA, 0V, or -10V) may be set to correspond to any low displayed reading **An Lo**. The high analog output (20 mA, 0V or 10V) may be set to correspond to any high displayed reading **An Hi**. The meter will then apply a straight line fit between these two end points to provide an analog output scaled to the meter reading. The decimal point location is fixed by the **dEC.Pt1** selection.





### KEYSTROKES FOR SETUP OF SINGLE ANALOG OUTPUT BOARD

If the **MENU** key does not work, see Section 9 “Enabling & Locking Out Menu Items.”

<b>Press Menu Key</b>	<b>Press Digit Select Key</b>	<b>Press Value Select Key</b>
<b>An SEt</b> Analog Output Setup. Press  until <b>AnSEt</b> is displayed.	<b>00</b> Calibration output selection.	<b>0</b> 0-20 mA current output <b>1</b> 0-10V voltage output <b>2</b> 4-20 mA current output <b>3</b> -10V to+10V voltage output
	<b>00</b> Analog output source.	<b>0</b> Filtered item <b>2</b> Item 2 <b>1</b> Item 1 <b>3</b> Item 3
<b>An Lo</b> Low displayed value for -10V, 0V, 0 mA, or 4 mA	<b>0.00000 0.00000 0.00000</b> <b>0.00000 0.00000 0.00000</b> Select digit to flash	Select <b>0</b> thru <b>9</b> for flashing digit.
<b>An Hi</b> High displayed value for 10V or 20 mA output	<b>0.00000 0.00000 0.00000</b> <b>0.00000 0.00000 0.00000</b> Select digit to flash	Select <b>0</b> thru <b>9</b> for flashing digit.

## KEYSTROKES FOR SETUP OF DUAL ANALOG OUTPUT BOARD

If the **MENU**  key does not work, see Section 9 “Enabling & Locking Out Menu Items.”

<b>MENU</b>  <b>Press Menu Key</b>	<b>PEAK</b>  <b>Press Digit Select Key</b>	<b>RESET</b>  <b>Press Value Select Key</b>
<b>An_SEt</b> Analog Output Setup. Press  until <i>AnSEt</i> is displayed.	<b>0000</b> Scaling of analog output 2	<b>0</b> 0-20 mA current output <b>1</b> 0-10V voltage output <b>2</b> 4-20 mA current output
	<b>0000</b> Source of analog output 2	<b>0</b> Filtered item <b>2</b> Item 2 <b>1</b> Item 1 <b>3</b> Item 3
	<b>0000</b> Scaling of analog output 1	<b>0</b> 0-20 mA current output <b>1</b> 0-10V voltage output <b>2</b> 4-20 mA current output
	<b>0000</b> Source of analog output 1	<b>0</b> Filtered item <b>2</b> Item 2 <b>1</b> Item 1 <b>3</b> Item 3
<b>An_Lo1</b> Low displayed value for 0V, 0 mA, or 4 mA output	<b>0.00000 0.00000 0.00000</b> <b>0.00000 0.00000 0.00000</b> Select digit to flash	Select <b>0</b> thru <b>9</b> for flashing digit.
<b>An_Hi1</b> High displayed value for 10V or 20 mA output	<b>0.00000 0.00000 0.00000</b> <b>0.00000 0.00000 0.00000</b> Select digit to flash	Select <b>0</b> thru <b>9</b> for flashing digit. <b>dEC.Pt1</b> selection.
<b>An_Lo2</b> Low displayed value for 0V, 0 mA, or 4 mA output	<b>0.00000 0.00000 0.00000</b> <b>0.00000 0.00000 0.00000</b> Select digit to flash	Select <b>0</b> thru <b>9</b> for flashing digit.
<b>An_Hi2</b> High displayed value for 10V or 20 mA output	<b>0.00000 0.00000 0.00000</b> <b>0.00000 0.00000 0.00000</b> Select digit to flash	Select <b>0</b> thru <b>9</b> for flashing digit.

## 16. SERIAL COMMUNICATIONS OPTIONS

A **serial communications board** may be connected to the meter main board at plug position P13 (middle position). Available boards are RS232, RS485 (with dual RJ11 connectors), RS485 Modbus (with dual RJ45 connectors), USB, USB-to-RS485 converter, Ethernet, and Ethernet-to-RS485 converter. The dual connectors of RS485 boards are wired in parallel to allow daisy chaining of addressable meters without use of a hub. Three serial communication protocols are selectable for all serial boards: Custom ASCII, Modbus RTU, and Modbus ASCII.

A **USB-to-RS485 converter board** or an **Ethernet-to-RS485 converter board** allows a meter to be interfaced to a computer and be the device server for a network of up to 31 other meters on an RS485 bus, while itself retaining all capabilities of a meter. The remote meters need to be equipped with our RS485 digital interface board with dual 6-pin RJ11 jacks, not our RS485 digital interface with dual 8-pin RJ45 jacks. The dual 6-pin RJ11 jacks on the RS485 board are wired in parallel to allow multiple meters to be daisy-chained using 6-wire data cables with no need for hand-wiring or an RS485 hub. The outer two wires are used for ground.





**Use 6-wire, straight-through data cables**, not 4-wire telephone cables or crossover cables, all the way from the device server to the last device on the RS485 bus. Connect ATX to ATX, BTX to BTX, etc., with no crossover as you go from device to device.

**To connect a meter with a USB board to a Windows PC**, use a USB cable with Type A and Type B connectors. Upon first connection, your computer may display “Found new Hardware” and automatically download and install the required USB driver from the Internet. If installation is not automatic, download the driver file (with a name like CDM v2.10.00 WHQL Certified.zip) from <http://www.ftdichip.com/Drivers/VCP.htm>. Unzip it into its own directory, and point to that directory as the location of the driver. You will need to use Device Manager (accessible from Control Panel) to determine the com port. Go down the device list and click on Ports (COM & LPT) and USB serial port (com #). Note the com port # for use with communications to your meter, then exit Control Panel. If you later need to change the Com port, right-click on USB serial port (com #), then on Properties, Port settings, and Advanced. Change port to the desired number, click OK, then exit Control Panel.

**To connect a meter with an Ethernet board to a computer**, see our separate Ethernet Manual, which covers our Node Manager Software. This Windows-based application runs on a host computer and is used to configure our Ethernet Nodes. It automatically discovers all Nodes on a LAN or WAN, plus any devices connected to Server Nodes via an RS485 bus. It is used to configure each Node, such as setting communication parameters, naming the Node and associated devices, entering email addresses for alarm notification and data requests, selecting the Node's time zone for time-stamping of emails and streaming data, and upgrading firmware. Once configuration data has been stored in flash memory of all Nodes, Node Manager Software can be closed. Node resident web server software is also provided.

### BOARD SETUP VIA JUMPERS

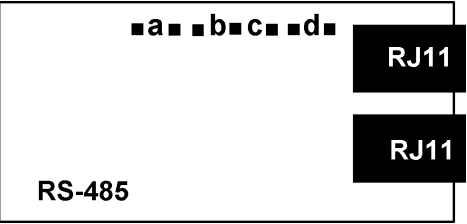
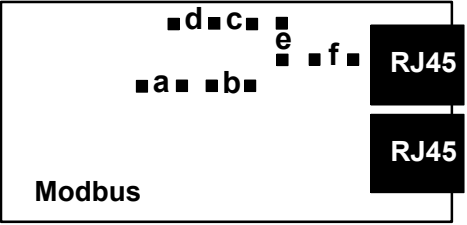
<p><b>USB Board</b> No jumpers required.</p>	 <p>The diagram shows a rectangular board with a single port on the right side. The port is labeled 'USB' in a black box. The word 'USB' is also printed on the board below the port.</p>
--	--

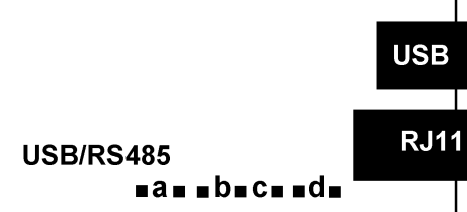
<p><b>Basic Ethernet Board</b> No jumpers needed.</p>	
<p><b>RS232 Board</b> e - Normal operation. f - Slave display to RS232 from another meter. g - Pull-up resistor on RTS line. <b>Note:</b> Board is shipped with jumpers e and g installed</p>	
<p><b>RS485 Board, Full Duplex Operation</b> b &amp; d - Installed on last meter in long cable run. <b>RS485 Board, Half Duplex</b> a &amp; c - Installed for half duplex operation. d - Installed on last meter in line with long cable runs. <b>Note:</b> Board is shipped with no jumpers installed.</p>	
<p><b>RS485-Modbus Board, Full Duplex Operation</b> b &amp; e - Bias jumpers should be installed on 1 board. a &amp; d - Installed on last meter in long cable run. <b>RS485-Modbus Board, Half Duplex Operation</b> b &amp; e - bias jumpers installed on 1 board. c &amp; f - installed for half duplex operation. a - installed on last meter in line with long cable runs. <b>Note:</b> Board is shipped with no jumpers installed.</p>	
<p><b>Ethernet-to-RS485 Converter Board &amp; USB-to-RS485 Converter Board</b> <b>Full Duplex Operation</b> No jumpers for short cable runs. Add b &amp; d for long cable runs. <b>Half Duplex Operation</b> a + c for short cable runs. Add d for long cable runs.</p>	 

# SERIAL CONNECTION EXAMPLES

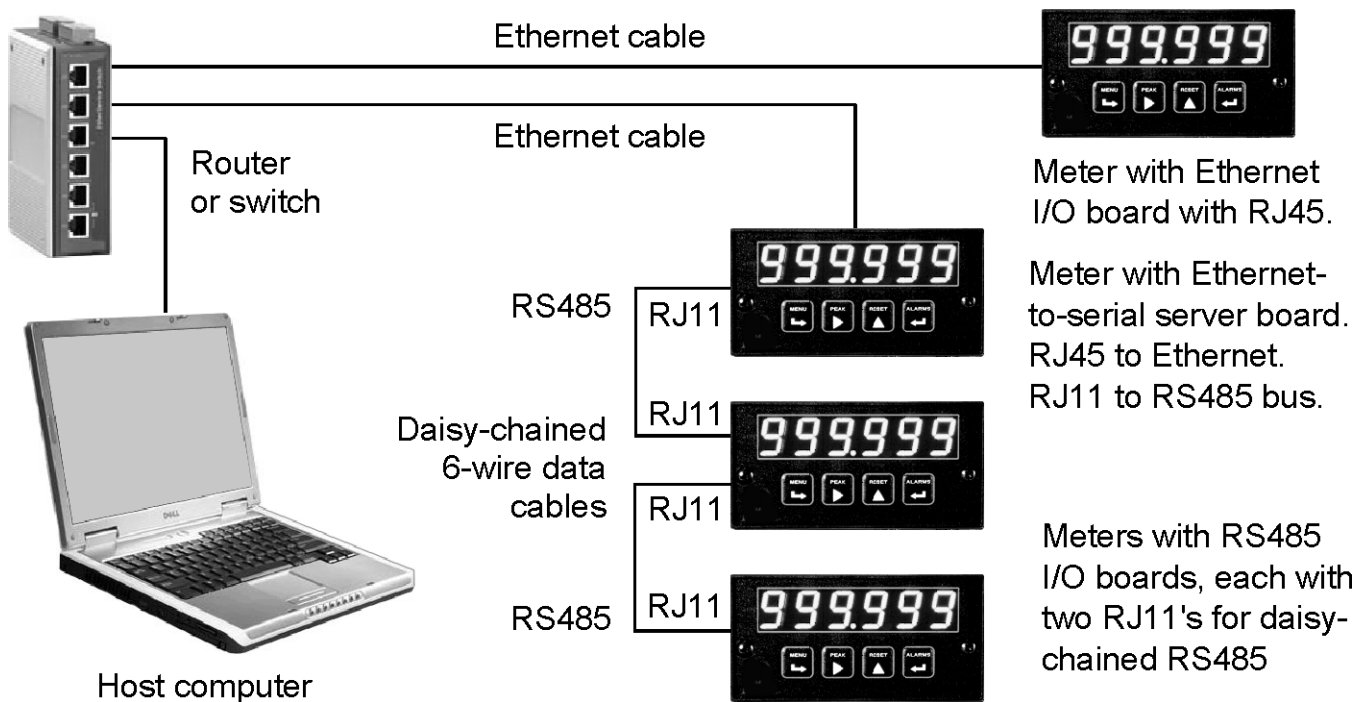
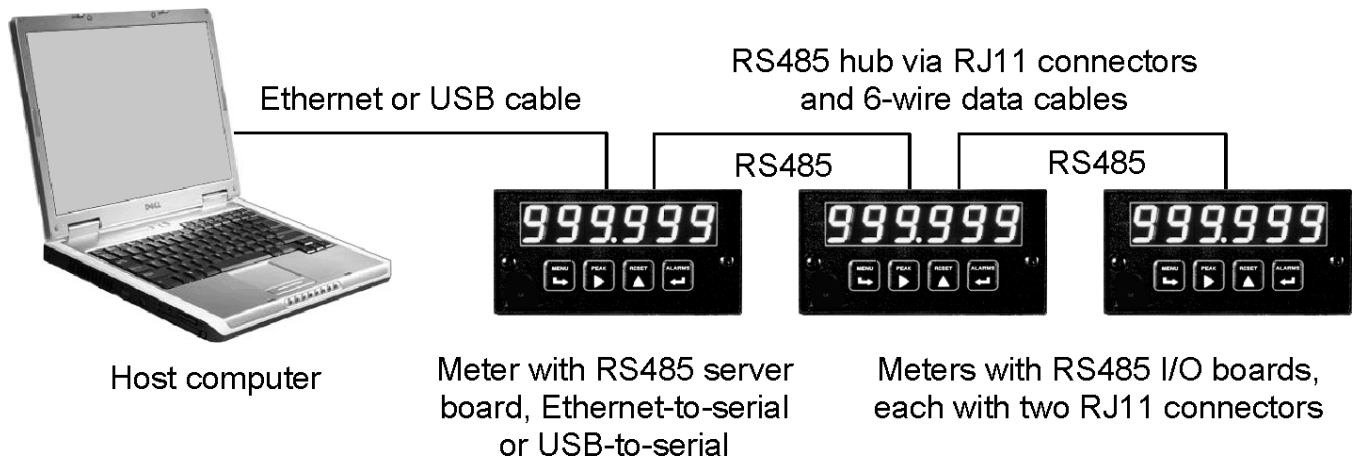
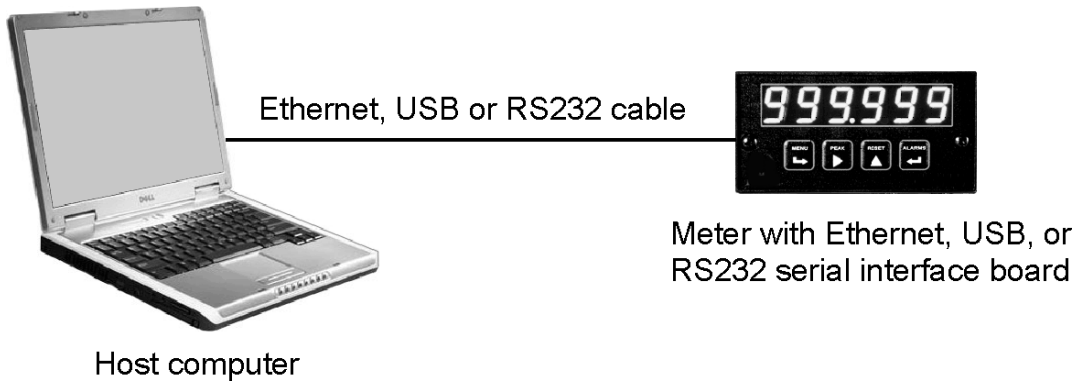

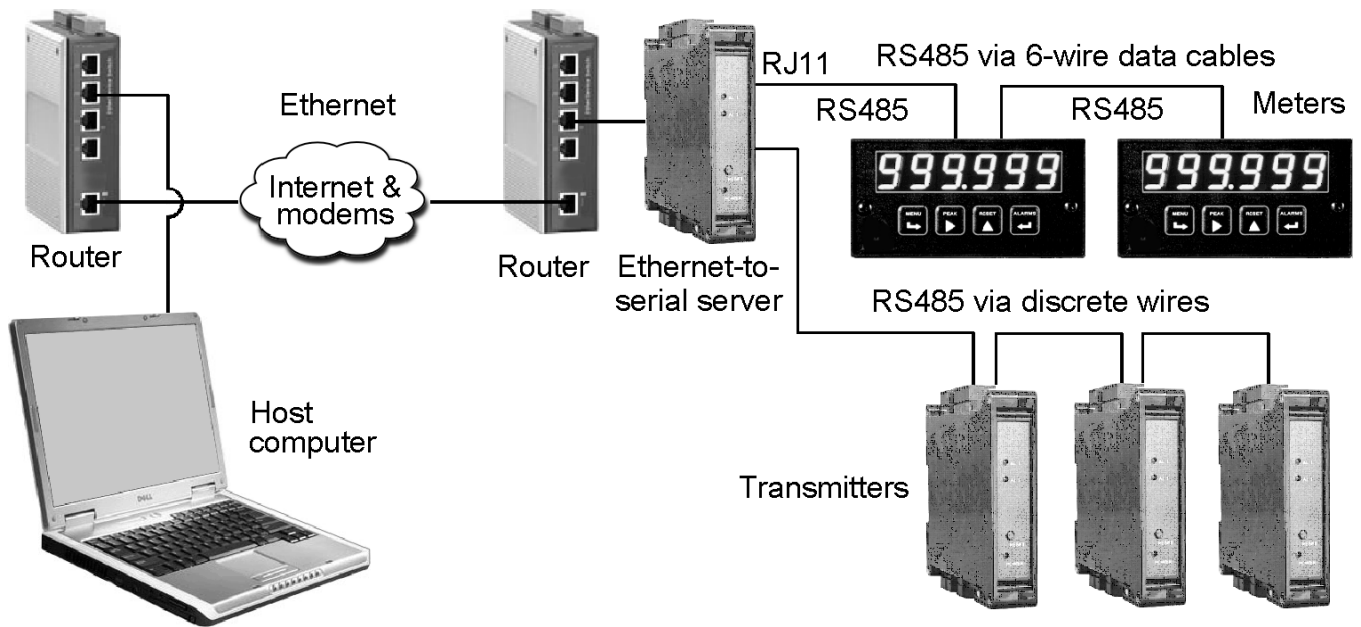

### KEYSTROKES FOR SETUP

If the *MENU* key does not work, see Section 9 “Enabling & Locking Out Menu Items.”

<b>MENU</b> Press Menu Key	<b>PEAK</b> Press Digit Select Key	<b>RESET</b> Press Value Select Key
<b>Ser 1</b> Serial Setup 1. Press  until Ser 1 is displayed.  <u>Fixed Parameters</u> No parity 8 data bits 1 stop bit	<b>000</b> Output filtering	<b>0</b> Send unfiltered signal <b>1</b> Send filtered signal
	<b>000</b> Baud rate	<b>0</b> 300 baud <b>4</b> 4800 baud <b>1</b> 600 baud <b>5</b> 9600 baud <b>2</b> 1200 baud <b>6</b> 19200 baud <b>3</b> 2400 baud
	<b>000</b> Digital output rate. rr = reading rate. rr depends on gate time and input frequency.	<b>0</b> Output at reading rate rr. <b>1</b> Output at rr/2 <b>5</b> Output at rr/32 <b>2</b> Output at rr/4 <b>6</b> Output at rr/64 <b>3</b> Output at rr/8 <b>7</b> Output at rr/128 <b>4</b> Output at rr/16 <b>8</b> Output at rr/256
<b>Ser 2</b> Serial Setup 2	<b>0000</b> Line feed	<b>0</b> No LF after carriage return <b>1</b> LF after carriage return
	<b>0000</b> Alarm data with readings	<b>0</b> No alarm data <b>1</b> Alarm data with reading
	<b>0000</b> Output mode control	<b>0</b> Continuous data output <b>1</b> Data output on ASCII command only
	<b>0000</b> Meter address with Custom ASCII protocol*	Select <b>0</b> thru <b>F</b> for addresses 1 thru 15. Select <b>0.</b> thru <b>F.</b> (with decimal point) for addresses 16 thru 31.



<b>MENU</b>  <b>Press Menu Key</b>	<b>PEAK</b>  <b>Press Digit Select Key</b>	<b>RESET</b>  <b>Press Value Select Key</b>
<b>Ser 3</b> Serial Setup 3	<b>00000</b> Half or full duplex	<b>0</b> Full duplex <b>1</b> Half duplex
	<b>00000</b> Recognition characters, start & stop characters. Special characters have to be download via Instrument Setup software.	<b>0</b> * (asterisk) is recognition character. No start & stop characters. <b>1</b> Custom recognition character. No start & stop characters. <b>2</b> * (asterisk) is recognition character. Special start & stop characters. <b>3</b> Custom recognition characters. Special start & stop characters.
	<b>00000</b> RTS mode	<b>0</b> Normal RTS <b>1</b> Single transmission
	<b>00000</b> CR (LF) termination characters.	<b>0</b> Only at end of all items <b>1</b> At end of each item
	<b>00000</b> Data sent in continuous mode	<b>0</b> All Active Items <b>1</b> Item #1 only <b>2</b> Item #2 only (if active) <b>3</b> Item #3 only (if active) <b>4</b> Peak only <b>5</b> Displayed Item <b>6</b> Valley only <b>7</b> All Active Items + Peak + Valley
<b>Ser 4</b> Serial Setup 4	<b>000</b> Modbus* ASCII gap timeout	<b>0</b> 1 sec <b>1</b> 3 sec <b>2</b> 5 sec <b>3</b> 10 sec
	<b>000</b> Serial protocol	<b>0</b> Custom ASCII* <b>1</b> Modbus* RTU <b>2</b> Modbus* ASCII
	<b>000</b> Parity	<b>0</b> None <b>1</b> Odd <b>2</b> Even
<b>Addr</b> Modbus Address	<b>000</b> <b>000</b> <b>000</b> Select digit to flash.	<b>158</b> Select <b>0</b> thru <b>9</b> for flashing digit. Address range is 1 to 247.

\* See Glossary for explanation of item.

# 17. EXCITATION OUTPUT & POWER SUPPLY

Three isolated transducer excitation output levels are available from the power supply board. These are selectable via jumpers b, c, d, e, f in the upper right of the board, as illustrated. In addition, the board provides three jumper positions for special features. The same jumper locations apply to the universal power supply (85-264 Vac or 90-300 Vdc) and to the low voltage power supply (12-32 Vac or 10-48 Vdc).

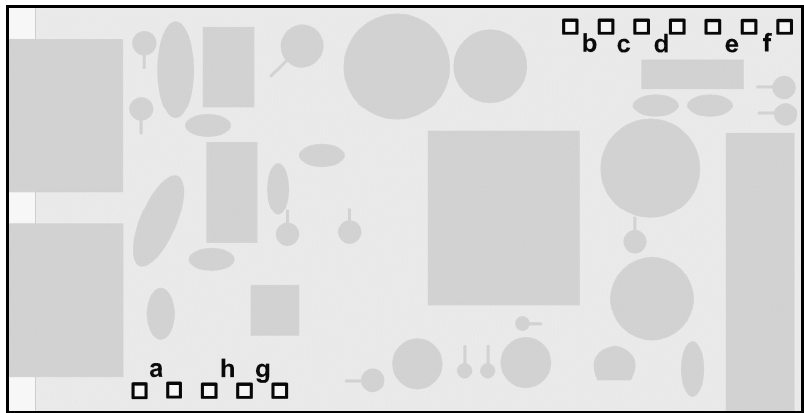

1. Letters indicate jumper position. Jumpers are installed on pins adjacent to letters.

Excitation output	Jumper locations													
5 Vdc $\pm$ 5%, 100 mA max	b, d, e	<table style="border: none; text-align: center;"> <tr> <td style="border: none;">■</td><td style="border: none;">b</td><td style="border: none;">■</td><td style="border: none;">■</td><td style="border: none;">■</td><td style="border: none;">d</td><td style="border: none;">■</td><td style="border: none;">■</td><td style="border: none;">■</td><td style="border: none;">e</td><td style="border: none;">■</td><td style="border: none;">■</td> </tr> </table>	■	b	■	■	■	d	■	■	■	e	■	■
■	b	■	■	■	d	■	■	■	e	■	■			
10 Vdc $\pm$ 5%, 120 mA max	b, d, f	<table style="border: none; text-align: center;"> <tr> <td style="border: none;">■</td><td style="border: none;">b</td><td style="border: none;">■</td><td style="border: none;">■</td><td style="border: none;">■</td><td style="border: none;">d</td><td style="border: none;">■</td><td style="border: none;">■</td><td style="border: none;">■</td><td style="border: none;">f</td><td style="border: none;">■</td><td style="border: none;">■</td> </tr> </table>	■	b	■	■	■	d	■	■	■	f	■	■
■	b	■	■	■	d	■	■	■	f	■	■			
24 Vdc $\pm$ 5%, 50 mA max	c	<table style="border: none; text-align: center;"> <tr> <td style="border: none;">■</td><td style="border: none;">■</td><td style="border: none;">c</td><td style="border: none;">■</td><td style="border: none;">■</td><td style="border: none;">■</td><td style="border: none;">■</td><td style="border: none;">■</td><td style="border: none;">■</td> </tr> </table>	■	■	c	■	■	■	■	■	■			
■	■	c	■	■	■	■	■	■						

## 2. SELECTION OF OTHER JUMPERS

**Jumper a** - Front panel menu lockout, locked when installed. See Section 9.

**Jumper g** - Sets P1-4 to be a +5V, 50 mA power output when installed.

**Jumper h** - Sets P1-4 to be Control Input 2 when installed (factory default).

## 18. INSTRUMENT SETUP VIA PC

*Instrument Setup* software is a PC program which is much easier to learn than front panel programming. It is of benefit whether or not the meter is connected to a PC. With the meter connected to a PC, it allows uploading, editing and downloading of setup data, execution of commands under computer control, listing, plotting and graphing of data, and computer prompted calibration. With the meter unconnected to a PC, it provides quick selection of jumper locations and a printable display of menu selections for front panel setup.

### SOFTWARE INSTALLATION

Download *IS2\*.exe* onto your PC from the web or the distribution CD. Double-click on the downloaded file to unzip it into a special directory, such as *c:\temp*. Within that directory, double-click on *setup.exe*, which will install the software on your PC.

### PREREQUISITES FOR CONNECTED USE

- 1) PC with an available RS232 or USB port.
- 2) Meter to be set up.
- 3) RS232 or USB board in the meter. This board can be removed following meter setup.
- 4) RJ11-to-DB9 cable from the meter to a PC RS232 com port, or a USB cable to a PC USB port (see Section 1, Ordering Guide).
- 5) *Instrument Setup* software.



RJ11-to-DB9 RS232 cable with rear view of DB9 connector to PC

### ESTABLISHING COMMUNICATIONS

Connect the meter and PC. Apply power to the meter. Be sure that the meter is in Run Mode, not Setup Mode. To start the software from Windows, click on *Start => Programs => IS2 => IS2*. Click on *RS232 => Establish*. The program will temporarily set the selected Com port to the required baud rate, parity, data bits and stop bit. Once communications have been established, click on *Main Menu*. The software will sense the type of meter and installed boards, but it cannot sense jumpers positions nor set jumpers for you. If the computer is not connected to a meter, select *Counter/Timer* and *Series 2*.

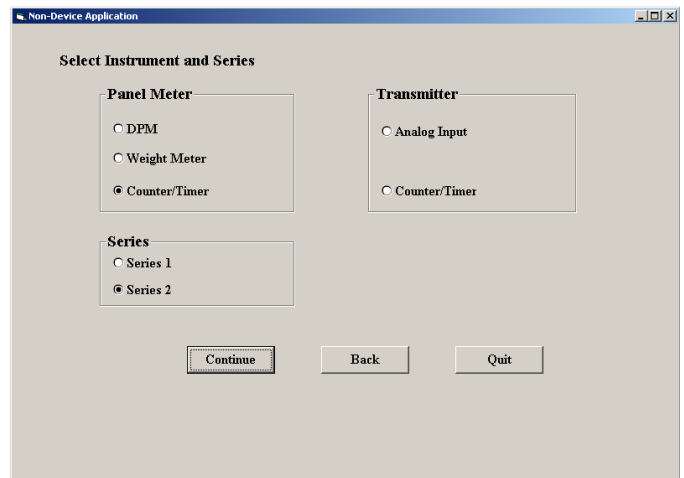
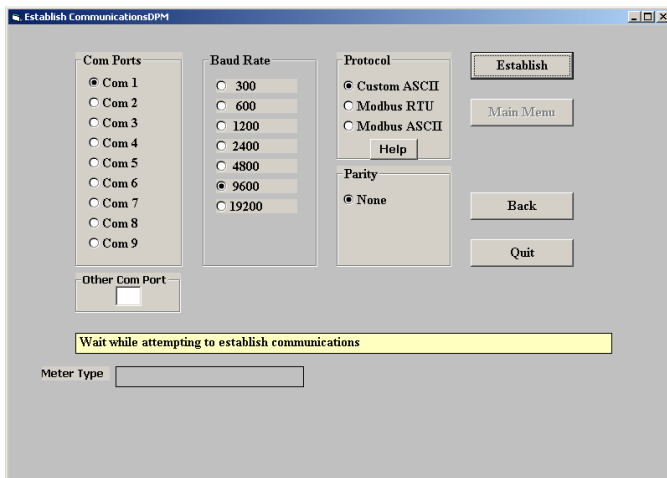

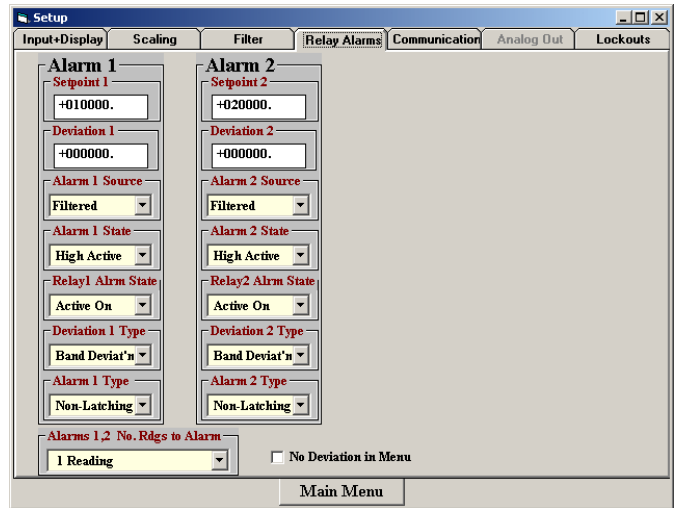
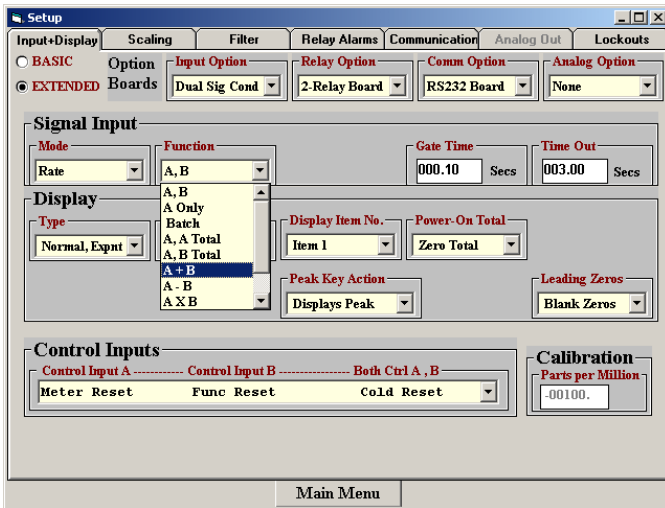

## SETUP OF CONNECTED METER

A setup file can be retrieved from the meter (*Counter => Get Setup*), be edited (*View => Setup*), be saved to disk (*File => Save Setup*), be retrieved from disk (*File => Open Setup*), and be downloaded into one or multiple meters (*Counter => Put Setup*). Downloading of setup files from a PC can be a major time saving when multiple counters have to be set up in the same way.

You will find that *Instrument Setup software* is very user friendly, with separate tab-selectable windows for *Input+Display*, *Scaling*, *Filter*, *Relay Alarms*, *Communications*, *Analog Out*, and *Lockouts*. If the required hardware, such as the analog output board, is not sensed, the corresponding tab will be grayed out.

## ADDITIONAL FEATURES WHEN CONNECTED

- **The Commands pull-down menu** allows you to perform Reset functions, to enter numerical values into the meter, and to retrieve numerical values from the meter (Items 1, 2, 3, Peak, Valley).

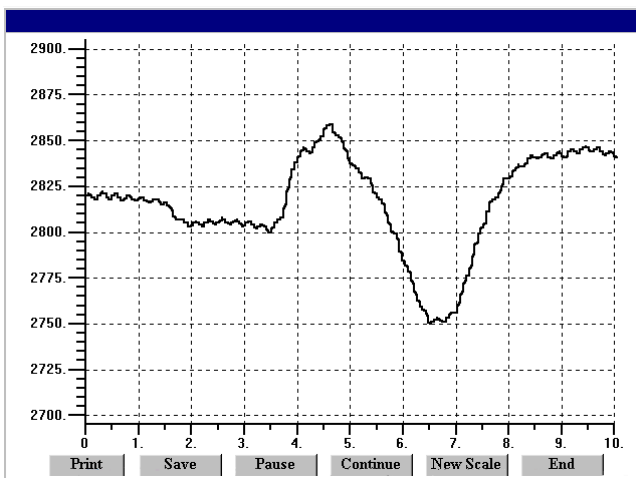

Plot

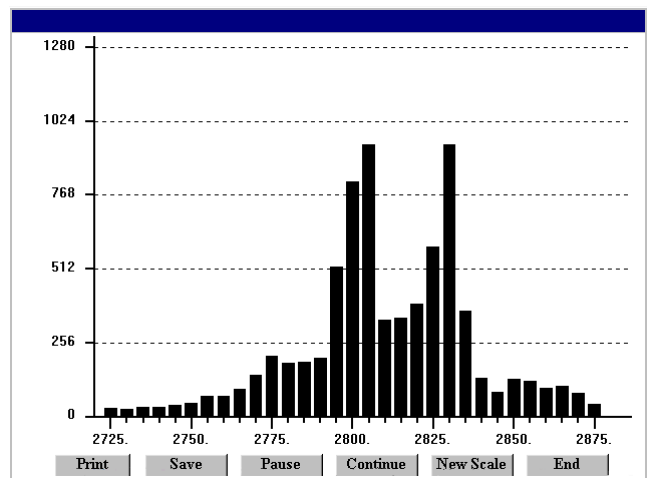

Graph

- **The Readings pull-down menu** provides three formats to display meter data on the PC monitor. Use the *Pause* and *Continue* buttons to control the timing of data collection, then press *Print* for a hardcopy record on your PC printer.
  - **List** presents the latest readings in a 20-row by 10-column table. Press *Pause* at any time to freeze the display. This is one method to capture peak readings.
  - **Plot** generates a plot of readings vs. time in seconds. It effectively turns the DPM-PC combination into a printing digital oscilloscope.
  - **Graph** generates a histogram, where the horizontal axis is the reading and the vertical axis is the number of occurrences of readings. The display continually resizes itself as the number of readings increases.
- **The Jumpers pull-down menu** shows board jumper corresponding to specific user selections.
- **The Calibration pull-down menu** allows easy frequency calibration of the quartz crystal. Simply apply a known calibration frequency up to 1 MHz to Channel A of the dual channel signal conditioner board, type in the frequency value in Hz, and press *Enter*.

## METER SETUP WITH AN UNCONNECTED PC

*Instrument Setup* software is also of benefit when the PC is not connected to a meter.

Upon launching the software, click on *None* for *Communications*, then on *Counter/Timer* and *Series 2*. Click on *File => Default Setup* to retrieve a default setup file from disk, or on *File => Open Setup* to retrieve a previously saved setup file from disk.

To enter new setup information, click on *View => Setup*, then make your screen selections as if you were connected to a meter. Tabs will be grayed out if you have not selected the required hardware under the *Input+Display* tab. When done, press on *Main Menu*, then on *View => Menu*. The selections made under *Setup* will now be shown in the form of the required front panel programming sequence, where each row corresponds to a menu item selected by the **↩** key, and the seven data columns correspond to values entered via the **▶** and **▲** keys.

Click on any step in the sequence to bring up a detailed help window.

Click on *Print* for a hardcopy, which you can then use as an instruction sheet to program your meter via its front panel.

Click on *Main Menu => File => Save Setup As* to save your setup to disk and have an electronic record.

Dig. No.	S	1	2	3	4	5	6
InPut				r	A	t	E
SEtUP		0	0	0	0	0	0
ConFIG				0	1	0	0
dSPyno						0	1
GAte t		0	0	0.	1	0	
ti Out		0	0	3.	0	0	
FiLteR		0	0	0	1	1	
SLOPE						0	1
DecPt1		1	1	1	1	1	1.
DecPt2		2	2	2	2	2	2.
SCALE1	+	1.	0	0	0	0	0
OFFSt1	+	0	0	0	0	0	0
SCALE2	+	1.	0	0	0	0	0
OFFSt2	+	0	0	0	0	0	0
SourcE				1	1		
AL SEt			0	0	0	0	0
dEUn1b	+	0	0	0	0	0	0
dEUn2b	+	0	0	0	0	0	0
SEr 1					0	5	0
SEr 2				0	0	1	1
SEr 3			0	0	0	0	1
SEr 4					0	1	0
Addr					0	0	1
CALib	-		0	0	1	0	0
Loc 1				0	0	0	0
Loc 2				0	0	0	0
Loc 3				0	0	0	0
Loc 4				0	0	0	0

## 19. CUSTOM CURVE LINEARIZATION

*Curve.exe* is a DOS-based, executable PC program used to set up an Extended meter so that the readings have a user-defined, non-linear relationship with the input signal. For example, it allows a meter to correct for non-linearity of transducers, or to display volume from pressure at the bottom of an irregularly shaped tank. The linearizing parameters are downloaded into non-volatile memory of the meter. The curve fitting algorithm uses quadratic segments of varying length and curvature, and provides diagnostics to estimate curve fitting errors. The program is self-prompting, avoiding the need for a manual.

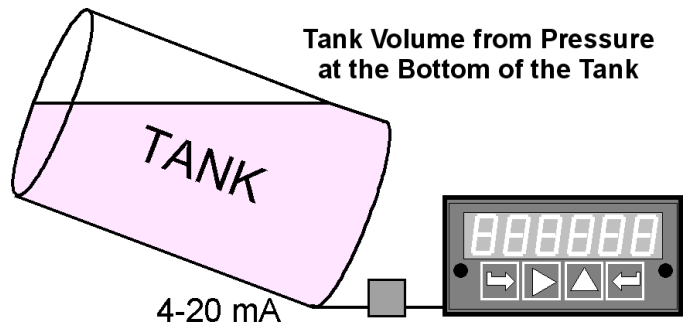

### PREREQUISITES

- 1) PC-compatible computer with an available RS232 or USB port.
- 2) Extended meter\*.
- 3) A serial communication board in the meter. This board can be removed following meter setup.
- 4) A suitable cable to connect the meter to a PC.
- 5) *Curve.exe* software (downloadable at no charge).



### GETTING STARTED

Download *curve.exe* into the same directory that will contain your data files, such as *c:\curves*. Set the meter to custom curve linearization. To do so, press the **→** key to get to **ConFG**, then set the fifth digit to **1**. This digit will only be displayed with an Extended meter\*. Set the meter baud rate to 9600. To do so, press the **→** key to get to **Ser 1**, then set the entry to **050**. Set the meter address to 1. To do so, press the **→** key to get to **Ser 2**, then set the entry to **0011**. To execute the program from Windows, simply double-click on *curve.exe*. No software installation is required.

### OPERATING MODES

The program will prompt you to enter your data in one of four modes. Pressing **R** (Enter) at any time returns you to the main menu.

- 1) **Text file entry mode**, with an X value in one column and a Y value in another. There can be additional columns, which are ignored. The file must have a DOS name of up to 8 characters and the extension **.RAW**. There can be from 5 to 180 rows. X is the input value and should be in the unit of measure for which the meter was set up, such as mV, V, mA or A. Y is the desired corresponding reading and can range from -99999 to 99999 with any decimal point.
- 2) **2-coordinate keyboard entry mode**, where an actual X input signal is applied, and the desired Y reading is entered from the keyboard.
- 3) **2-coordinate file entry mode**, where an actual X input signal is applied, and the desired Y reading is provided from a file.

- 4) **Equation entry mode**, where the coefficients of a polynomial  $Y = K1X^P1 + K2X^P2 + K3X^P3 + \dots$  are entered. Up to 20 terms are allowed. And offset can be built into X.

## REQUIRED USER INPUTS

- Select CTR
- You will be asked to supply the following:  
LOW X-COORDINATE VALUE >  
LOW INPUT MEASUREMENT VALUE >  
HIGH X-COORDINATE VALUE >  
HIGH INPUT MEASUREMENT VALUE >

This informs the computer of your signal conditioner jumper settings. Enter 0 and 0 for the two LOW values. For HIGH X, enter your signal conditioner jumper range in the same units of measure that you will be using in your \*.RAW data input file. Enter **20** for 20 mA or **10** for 10V. For HIGH INPUT MEASUREMENT VALUE, enter **100000**,

You will be asked to select the position of the decimal point from 6=X.XXXXX, 5=XX.XXX, 4=XXX.XXX, 3=XXXX.XX, 2=XXXXX.X, 1=XXXXXX (for DPMs, the leading X is a blank). Specify the same position that you specified in the **dEc.Pt1** decimal point menu selection.

## 20. METER CALIBRATION

All ranges of the meter have been digitally calibrated at the factory prior to shipment using computers and calibration equipment certified to NIST standards. If recalibration is required, the meter may be returned to the factory or to any authorized distributor.

For frequency and rate measurements with the dual-channel signal conditioner, a calibration correction to the quartz crystal oscillator is stored in EEPROM on the main board. Calibration constants are also stored in EEPROM in the process receiver & totalizer signal conditioner board and in the analog output board. As a result, these two boards can be mixed and interchanged without requiring recalibration.

For frequency calibration using the dual-channel signal conditioner board, calibration may be performed in the field as follows using the front panel pushbuttons:

1. Set *InPut* to *rAtE* and *A only*.
2. Enter 0 in *CALib* to set initial correction to 0 PPM.
3. Set *SCALE* to -9.99999
4. Set *OFFSt1* to 999999
5. Apply a 100 kHz reference signal to channel A.
6. Enter the displayed reading in *CALib*.

For calibration of the process receiver & totalizer signal conditioner board or analog output board, an RS-232 board must be installed in the meter for serial communication with a PC. This board may be removed upon completion of calibration. Calibration software and step-by-step instructions are available from the factory.

## 21. SPECIFICATIONS

### DISPLAY

Type ..... 6 LED digits, 7-segment, 14.2mm, plus 4 LED indicators  
Digit Color ..... Red or green  
Display Range ..... -999999 to +999999

### CONVERSION (FREQUENCY INPUT)

Conversion Technique ..... 1/period  
Conversion Rate ..... Gate Time + 30 ms + 2 signal periods (max)  
Gate Time ..... 0 to 199.99 sec (selectable)  
Time Before Zero Output (Time-Out) ..... 0 to 199.99 sec (selectable)  
Output & Display Update Rate ..... Same as conversion rate  
Time Base Accuracy ..... Calibrated to  $\pm 2$  ppm

### INPUT ISOLATION

CMV from DC to 60 Hz ..... Withstand 250Vac  
Dielectric strength ..... 3.5 kV ac for 5 sec, 2.3 kV ac for 1 min

### DUAL CHANNEL SIGNAL CONDITIONER

Accuracy at 25°C .....  $\pm 2$  ppm  
Tempco .....  $\pm 1$  ppm/degree C  
Long-Term Drift of Crystal .....  $\pm 5$  ppm/year  
Signal Types ..... AC, NPN, PNP transistor outputs, contact closures, magnetic pickups  
Max Pulse Rate ..... 1 MHz on Channel A, 250 kHz on Channel B  
Channel Isolation ..... Channel A & channel B share common ground  
Low Pass Filter ..... 250 Hz or 30kHz (selectable)  
Hysteresis ..... 15 mV to 2.2 Vp-p (selectable)  
Trigger Level .....  $\pm 15$  mV to  $\pm 1.7$  V (selectable)  
Debounce Circuitry ..... 0, 3, 50 ms (selectable)

### PROCESS RECEIVER & TOTALIZER SIGNAL CONDITIONER

Input Signal Levels ..... 4-20 mA, 0-1 mA, 0-10 V (jumper selectable)  
Input Resistance ..... 50 $\Omega$  for 4-20 mA, 1.00 k $\Omega$  for 0-1 mA, 1.01 M $\Omega$  for 0-10V  
Accuracy at 25°C .....  $\pm 0.025\%$   
Span Tempco .....  $\pm 0.003\%$  of reading /°C  
Zero Tempco .....  $\pm 0.003\%$  of full scale /°C

### QUADRATURE SIGNAL CONDITIONER

Signal Type ..... Differential or single-ended quadrature  
Transitions Monitored ..... x1, x2 or x4  
Max Pulse Rate ..... 250 kHz at x1, 125 kHz at x2, 62.5 kHz at x4  
Differential High Threshold Voltage ..... +200 mV  
Differential Low Threshold Voltage ..... -200 mV  
Single-ended High Voltage ..... 2.5V to 10V  
Single-ended Low Voltage ..... -1V to +1V  
Input resistance, Typ ..... 17 k $\Omega$



Conversion Technique for Rate..... 1/period  
 Conversion Time for Rate ..... Gate time + 30 ms + 0-2 signal periods  
 Time Before Zero Output for Rate ..... 0 to 199.99 sec (selectable)  
 Zero Wait Time for Rate ..... 0 to 199.99 sec (selectable)  
 Output & Display Update Rate ..... Same as conversion rate  
 Time Base Accuracy for Rate..... Calibrated to  $\pm 2$  ppm

**POWER REQUIREMENTS**

Input Voltage Rating (standard)..... 85-264 Vac or 90-300 Vdc  
 Input Voltage Rating (low voltage option)..... 12-32 Vac or 10-48 Vdc  
 Power Line Frequency ..... DC and 47-63 Hz  
 Power Consumption, Max ..... 5 Watts

**EXCITATION OUTPUTS**

Voltage & Current Levels (jumper selectable)..... 5V dc  $\pm 5\%$ , 100 mA max  
 10V dc  $\pm 5\%$ , 120 mA max  
 24V dc  $\pm 5\%$ , 50 mA max  
 Excitation Output Ripple..... 100 mVp max  
 Isolation from Power and Outputs ..... 250 Vac  
 Insulation Dielectric Strength to Power & Outputs..... 3.5 kV ac for 5 sec, 2.3 kV ac for 1 min  
 Isolation to Signal Common ..... 50V dc

**DUAL OR QUAD RELAY OPTIONS**

Power to Relay Option ..... Powered by meter  
 Setpoint Setup..... Via front panel pushbuttons or RS232/485  
 Update Rate ..... 56/s at 60 Hz, 47/s at 50 Hz  
 Response to Input Signal (min) ..... Display update rate  
 Input Signal (selectable)..... Filtered or unfiltered input signal  
 Actuation Modes (selectable)..... Above or below setpoint, latching or non-latching, disabled  
 Output Time Delay (selectable)..... 1 to 128 readings  
 Front Panel Enable / Lockout Modes (selectable)..... 1) Display and change setpoints  
 2) Display but do not change setpoints  
 3) Neither display nor change setpoints  
 Alarm Status Indication ..... 2 or 4 red LED lamps  
 Status Indication Setup (selectable)..... Lit when output is ON or OFF

**Form C, SPDT Relay Output:**

AC Rating ..... 8A @ 240 Vac  
 DC Rating ..... 8A @ 24 Vdc  
 Isolation rating between signal common and contacts ..... 250 Vac  
 Insulation dielectric strength between signal common and contacts .....  
 ..... 3.5 kV ac for 5 sec, 2.3 kV ac for 1 min

**Form A, SPST Solid State Relay Output:**

AC Rating ..... 120 mA @ 140 Vac  
 DC Rating ..... 120 mA @ 180 Vdc  
 Isolation rating between signal common and contacts ..... 250V ac  
 Insulation dielectric strength between signal common and contacts .....  
 ..... 3.5 kV ac for 5 sec, 2.3 kV ac for 1 min

## ANALOG OUTPUT OPTION

Power to Analog Output Option.....	Powered by meter
Output Levels, Single Analog Output Option.....	0-20 mA, 4-20 mA, 0-10V, -10 to +10V
Output Levels, Dual Analog Output Option .....	0-20 mA, 4-20 mA, 0-10V
Voltage Compliance, 0-20 mA Output .....	12V (0-600 Ohm load)
Current Compliance, 0-10V Output .....	2 mA (5 kOhm or higher load)
Accuracy .....	Meter input accuracy $\pm 0.02\%$ of full scale analog output
Resolution .....	16 bit (1 part in 65,536)
Response Time .....	meter update rate
Scaling of Reading for Zero Output.....	-999,999 to +999,999
Scaling of Reading for Full Scale Output.....	-999,999 to +999,999
Isolation rating between signal common and analog output.....	250V ac
Insulation dielectric strength between signal common and analog output.....	3.5 kV ac for 5 sec, 2.3 kV ac for 1 min

## SERIAL INTERFACE OPTIONS (Ethernet, USB, RS232, RS485, RS485-Modbus boards)

Output Types.....	RS232, RS485, RS485-Modbus, USB, USB-to-RS485 converter, Ethernet, Ethernet-to-RS485 converter
Power to Interface Option.....	Powered by meter
RS485 Wiring .....	Half or full duplex
Baud Rates .....	300, 600, 1200, 2400, 4800, 9600, 19200
Serial Protocols .....	Custom ASCII, Modbus RTU, Modbus ASCII (selectable)
Signal Levels .....	Meet RS232, RS485, USB, Ethernet standards
Isolation rating between signal common and serial I/O .....	250V ac
Insulation dielectric strength between signal common and serial I/O .....	3.5 kV ac for 5 sec, 2.3 kV ac for 1 min

### Option Board Connectors:

RS232 .....	Single RJ11 jack
RS485 .....	Two RJ11 jacks (for daisy chaining with 6-wire data cables)
RS485 Modbus.....	Two RJ45 jacks (for daisy chaining with 8-wire data cables)
USB.....	USB type B plug
USB-to-RS485 converter.....	USB type B plug plus RJ11 jack to RS485 bus
Ethernet.....	Single RJ45 jack to Ethernet
Ethernet-to-RS485 converter.....	RJ45 jack to Ethernet plus RJ11 jack to RS485 bus

## ENVIRONMENTAL

Operating Temperature .....	0°C to 55°C
Storage Temperature .....	-40°C to 85°C
Relative Humidity .....	95% from 0°C to 40°C, non-condensing
Case.....	NEMA-4X (IP65) from front when panel mounted (not verified for UL)
Shock .....	10 G at 1 kHz, applied in X, Y, Z axes
Vibration .....	15 Hz to 150 Hz, 1 mm to 2 mm amplitude, 20 G max.

## 22. GLOSSARY OF TERMS

### Adaptive filter threshold

A threshold which causes an adaptive moving average filter to be reset to the latest reading when the accumulated difference between individual readings and the filtered reading exceeds that threshold. Adaptive moving average filtering allows a meter to respond rapidly to actual changes in signal while filtering out normal noise. The accumulated difference is also reset to zero when the latest reading has a different polarity than the filtered reading. A low adaptive filter threshold is normally selected. A high filter threshold should be selected if the signal has large transients.

### Alarm, latched

An alarm which stays actuated until reset. Latched alarms can shut down machinery or a process when an operating limit has been exceeded, or maintain an alarm condition until acknowledged by an operator.

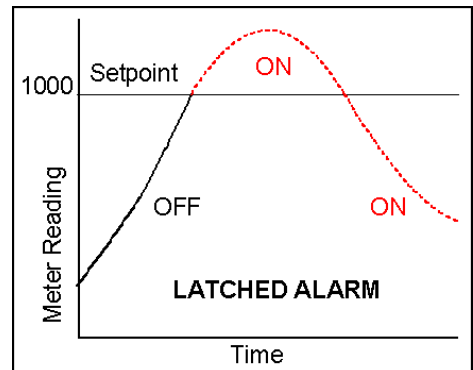

### Alarm, non-latched

An alarm which changes state automatically when the reading rises above a specified limit and changes back automatically when the reading falls below a limit.

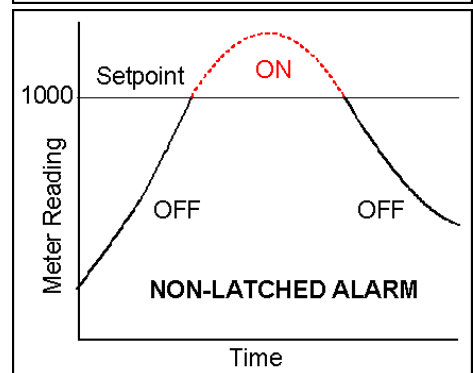

### Autofilter

A selectable digital filter mode which automatically selects an appropriate moving average filter time constant from 0.08 sec to 9.6 sec for the encountered noise condition.

**Batch control** An operating mode of the Extended counter with a relay board, where the counter is used to control repetitive fill operations by counting up from zero to a preset, or counting down from a preset to zero.

### Calculated total

While most totals are based on direct pulse counts, certain totals are calculated as running totals based on displayed rate (e.g., Total A, Rate A). The totalizing process assumes that rate is displayed in units per second, such as 300 gallons per second, allowing a scale factor of 1 to be used. If the rate is not in units per second, a different scale factor has to be applied.

### Coordinates of 2 points method

A scaling method where the coordinates of 2 points are entered. For a pulse rate input, the first entered point would be low frequency in Hz and low desired reading. The second entered point would be high frequency in Hz and high desired reading.

### Counts

The reading displayed on the meter ignoring the decimal point.

### Custom ASCII protocol

A simplified, short protocol for use with panel meters, counters and timers. It allows 31 digital addresses. Not an industry-standard protocol, like the more complex *Modbus protocol*, which is also offered with these instruments.

**Custom curve** A user-specified nonlinear relationship between the input signal and displayed reading. Custom curve linearization is available with the *Extended counter*. One way to supply the data is via a text file with up to 180 data points, which is processed on a PC using furnished software and is then downloaded into EEPROM via serial communications.

**Cutoff** A programmable threshold in units of flow applicable to Total and Batch Control with the process receiver and totalizer signal conditioner. Flow rates below the cutoff, deemed to be zero offset errors, will not be totalized. Otherwise, small zero offset errors could result in a large error if accumulated over a long time.

### Deviation band

A band in counts which controls relay action symmetrically around a *setpoint*. The relay actuates when the reading falls within the deviation band, and de-actuates when the reading falls outside of this band. A deviation limit (e.g., 50 counts) is set up around both sides of the setpoint to create a deviation band (e.g., 100 counts). Setting up a pass-band around a setpoint is often used for component testing. Deviation limits are programmed by entering menu item *dEUn1b* for Alarm 1 and *dEUn2b* for Alarm 2.

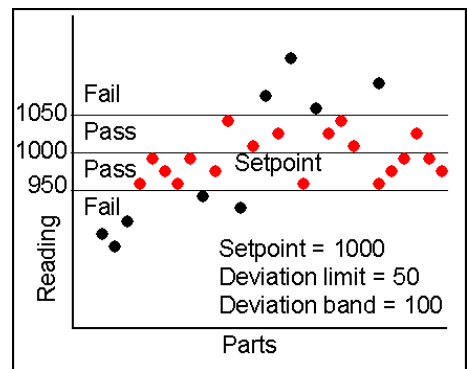

**Duty cycle** ON or OFF period of square waves as a percentage of total period over a *gate time* which is selectable from 10 ms to 199.99 sec. With the dual input signal conditioner, the same signal is applied to Channels A and B. Duty cycle can then be read out with resolution to 0.01%.

### Extended counter

A counter with an enhanced microcomputer main board that provides added capabilities, such as *custom curve* linearization of nonlinear inputs and display of rate of change from successive readings.

**Frequency** Rate in cycles per second or Hertz (Hz). In rate meter mode, a scale factor of 1 and offset of 0 cause a display directly in Hertz with resolution of 1 Hz. To increase or decrease resolution, increase or decrease the scale factor.

### Function reset

A rear panel input which resets Peak, Valley and any latched alarms. Latching is achieved by tying the input to logic ground or applying 0V (logic level true). Reset is achieved by opening the input or applying +5V (logic level false).

**Gate Time** A user-specified time interval from 10 ms to 199.99 sec over which the meter measures frequency. The meter times an integral number of signal periods over the gate time, and then taking the inverse of period. The display update rate of the meter is gate time + 1 period + 30 ms. Selecting a longer gate time produces a more stable reading as more cycles are averaged, but slows down

the update rate. At very low frequencies, the update rate of the meter is controlled by the period. In totalizing mode, the gate is always open, but the gate time setting still determines the update rate of the meter. See also *Time-out* or *Time before zero output*.

### Hysteresis, Split

Relay operation is specified symmetrically around a setpoint. The relay closes (or opens) when the reading rises above the setpoint plus one hysteresis limit, and opens (or closes) when the reading falls below the setpoint less one hysteresis limit. A narrow hysteresis band can be used to minimize relay chatter. A wide hysteresis band can be used for control.

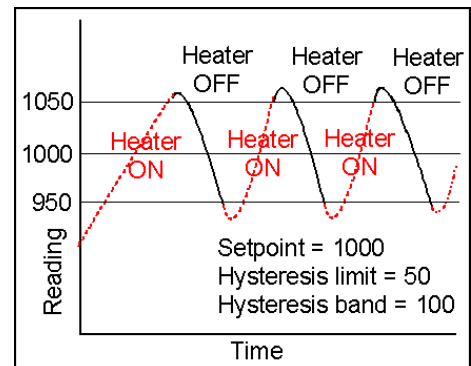

### Hysteresis, Span

Same relay operation as for split hysteresis, but specified differently. Here the setpoint is the upper control limit, and the lower control limit is the setpoint less the hysteresis band.

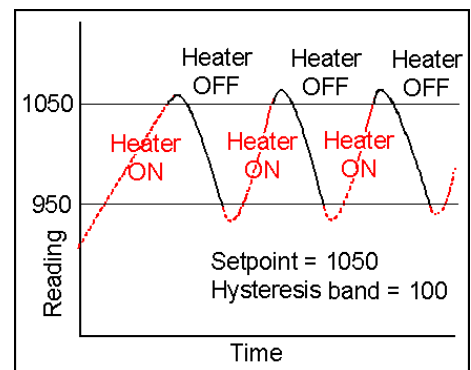

### Item #

Also called Display Item. A numerical value in the meter available for display under control of a front panel key or serial communications. For example, in the A+B totalizer mode, the sum of A+B is Item #1, Total A is Item #2, and Total B is Item #3. When the meter is reset, Item #1 is always displayed. To view another Item, press the *RESET* key. For Item 1, the yellow View "V" LED is unlit. For Item 2, the "V" LED is lit. For Item 3 the "V" LED flashes.

### Menu mode

Meter programming mode used for input and range selection, setup, and configuration. Entered into from the Run mode by pressing the MENU key. Can be locked out by a jumper on the power supply board.

### Meter Hold

A rear panel input which freezes the meter display and all meter outputs while that input is tied to logic ground by a switch or is held at 0V (logic level true). The meter will resume operation when the input is disconnected or is held at +5V (logic level false).

### Moving average filter

A digital filter mode which displays a weighting moving average of readings. Eight moving average modes are selectable with the following RC time constants: no filter, 0.1 sec, 0.2 sec, 0.4 sec, 0.8 sec, 1.6 sec, 3.2 sec, 6.4 sec.

### Multiplier

A constant multiplier from 0.00001 to 100000 (in decade steps) that is combined with a *scale factor* from 0.00000 to 9.99999 (fixed decimal point and settable digits) to go from frequency in Hz to rate in engineering units such as gallons per minute or from pulse counts to total in engineering units, such as gallons. The combination of a 6-digit scale factor with a multiplier provides more dynamic range with no loss of resolution than could be achieved with a 6-digit scale factor only.

<b>Offset</b>	A constant adder to the displayed reading. This may be any value from -999,999 to 999,99. The offset may be used as a preset in the totalize mode, where the total can be counted down from the preset to zero.
<b>Peak display</b>	The maximum (or most positive) reading since that value was last reset. Reset can be via the meter front panel, an external input, or a software command. The displayed value can reflect the filtered or unfiltered readings.
<b>Period</b>	The time of one complete cycle of the input frequency. A scale factor of 1 and multiplier of 1 produce a display in microseconds.
<b>Phase angle</b>	The lead or lag in degrees between two AC signals of the same frequency. With signals applied to Channels A and B of the dual pulse input signal conditioner, phase angle can be displayed from -180° to +180° with 0.01° resolution.
<b>Pulses</b>	Voltage waveshapes with leading and trailing edges that are detected for determination of frequency, period or time. With the quadrature signal conditioner, the menu item <i>Pulses</i> is used to set the number of pulses generated by a quadrature encoder for each zero index pulse. This setting is equal to the number of pulses per revolution of the encoder (times 2 or 4 if the count by 2 or 4 is selected on the signal conditioner) times the scale factor.
<b>Process signal</b>	An analog signal whose display requires setup of <i>scale</i> and <i>offset</i> for display in engineering units (such as psi). The process receiver & totalizer signal conditioner accepts 0-1 mA, 4-20 mA or 0-10 V process signals.
<b>Quadrature</b>	A quadrature encoder generates 2 signals that are 90° out of phase based on the position of a rotor or linear scale. The phase relationship of these signals depends on the direction of rotation of the encoder. The meter counts up or down depending on the phase. Quadrature is used for very accurate determination of length or position.
<b>Rate</b>	Same as frequency, except that a <i>scale factor</i> and <i>multiplier</i> have been applied to convert the reading in Hz to a reading in engineering units, such as RPM.
<b>Remote Display</b>	A display mode which allows a counter to serve as a 6-digit remote display when connected to a computer or meter via a serial communications output.
<b>Reset</b>	Two types of Reset are applicable to counter/timer operation: <ul style="list-style-type: none"> <li>▪ Peak and Valley Reset. Achieved by simultaneously pressing the <i>RESET</i> and <i>PEAK</i> keys.</li> <li>▪ Latched Alarm Reset. Achieved by simultaneously pressing the <i>RESET</i> and <i>ALARMS</i> keys.</li> </ul>
<b>Resolution</b>	A menu item which controls the resolution of arithmetic functions (A+B, A-B, AxB, A/B, A/B-1) of Grand Total in batch mode. It multiplies the displayed value by a factor of 0.00001 to 100,000 in decade steps. The decimal point then has to be moved appropriately.

**RS485 half duplex**

Serial communications implemented with two wires, allowing data transmission in both directions, but not simultaneously.

**RS485 full duplex**

Serial communications implemented with four wires, allowing data transmission in two directions simultaneously.

**Run Mode**

The normal operating mode of the meter, where readings are taken, as opposed to the *menu mode*.

**Scale factor**

A constant multiplier used to go from a raw reading in pulses per second or total pulses to a reading in engineering units. The scale factor consists of a scale value from 0.00000 to 9.99999 (fixed decimal point, settable digits) and a scale multiplier from 0.00001 to 100000 (in decade steps).

**Scaling**

The process of setting *scale* and *offset* so that the meter reads properly in engineering units (such as gallons/minute).

**Scaling, coordinates of 2 points method**

A scaling method where four numbers are entered manually: low input, desired reading at low input; high input, and desired reading at high input. The meter then applies a straight line fit.

**Scaling, scale and offset method**

A scaling method where *scale* and *offset* are entered manually.

**Setpoint**

A value compared to the reading to determine the state of a relay. Term often used interchangeably with “alarm setpoint.”

**Stopwatch mode**

A timing operating mode for single events. Stopwatch A-to-A measures time between the same positive (or negative) edge of start and stop pulses applied to Channel A. Stopwatch A-to-B measures time between a start pulse on Channel A and a stop pulse on Channel B.

**Time interval mode**

Returns the average duration of repetitive events over a programmed gate time. Time may be measured from the leading or trailing edge of pulses applied to Channel A to the leading or trailing edge of pulses applied to Channel B.

**Time-out (or time before zero output)**

The time the meter waits for a signal to start or end a conversion. If pulses are not received before the time-out ends, the meter reads zero. The longer the time-out, the lower the minimum frequency the meter can display. This term is also used for the programmable time that the batch relay stays de-energized at the end of a batch cycle.

## 24. WARRANTY

**Yokogawa Corporation of America** warrants its products against defects in materials or workmanship for a period of one year from the date of purchase.

In the event of a defect during the warranty period, the unit should be returned, freight prepaid (and all duties and taxes) by the Buyer, to the authorized Yokogawa distributor where the unit was purchased. The distributor, at its option, will repair or replace the defective unit. The unit will be returned to the buyer with freight charges prepaid by the distributor.

### **LIMITATION OF WARRANTY**

The foregoing warranty shall not apply to defects resulting from:

1. Improper or inadequate maintenance by Buyer.
2. Unauthorized modification or misuse.
3. Operation outside the environmental specifications of the product.
4. Mishandling or abuse.

The warranty set forth above is exclusive and no other warranty, whether written or oral, is expressed or implied. Yokogawa specifically disclaims the implied warranties of merchantability and fitness for a particular purpose.

### **EXCLUSIVE REMEDIES**

The remedies provided herein are Buyer's sole and exclusive remedies. In no event shall Yokogawa be liable for direct, indirect, incidental or consequential damages (including loss of profits) whether based on contract, tort, or any other legal theory.