

BK PRECISION®

Model: PVS10005, PVS60085, PVS60085MR

High Power Programmable DC Power Supply

USER MANUAL



Safety Summary

The following safety precautions apply to both operating and maintenance personnel and must be followed during all phases of operation, service, and repair of this instrument.

WARNING

Before applying power to this instrument:

- Read and understand the safety and operational information in this manual.
- Apply all the listed safety precautions.
- Verify that the voltage selector at the line power cord input is set to the correct line voltage. Operating the instrument at an incorrect line voltage will void the warranty.
- Make all connections to the instrument before applying power.
- Do not operate the instrument in ways not specified by this manual or by B&K Precision.

Failure to comply with these precautions or with warnings elsewhere in this manual violates the safety standards of design, manufacture, and intended use of the instrument. B&K Precision assumes no liability for a customer's failure to comply with these requirements.

Category rating

The IEC 61010 standard defines safety category ratings that specify the amount of electrical energy available and the voltage impulses that may occur on electrical conductors associated with these category ratings. The category rating is a Roman numeral of I, II, III, or IV. This rating is also accompanied by a maximum voltage of the circuit to be tested, which defines the voltage impulses expected and required insulation clearances. These categories are:

Category I (CAT I): Measurement instruments whose measurement inputs are not intended to be connected to the mains supply. The voltages in the environment are typically derived from a limited-energy transformer or a battery.

Category II (CAT II): Measurement instruments whose measurement inputs are meant to be connected to the mains supply at a standard wall outlet or similar sources. Example measurement environments are portable tools and household appliances.

Category III (CAT III): Measurement instruments whose measurement inputs are meant to be connected to the mains installation of a building. Examples are measurements inside a building's circuit breaker panel or the wiring of permanently-installed motors.

Category IV (CAT IV): Measurement instruments whose measurement inputs are meant to be connected to the primary power entering a building or other outdoor wiring.

 **WARNING**

Do not use this instrument in an electrical environment with a higher category rating than what is specified in this manual for this instrument.

 **WARNING**

You must ensure that each accessory you use with this instrument has a category rating equal to or higher than the instrument's category rating to maintain the instrument's category rating. Failure to do so will lower the category rating of the measuring system.

Electrical Power

This instrument is intended to be powered from a CATEGORY II mains power environment. The mains power should be 120 V RMS or 240 V RMS. Use only the power cord supplied with the instrument and

ensure it is appropriate for your country of use.

Ground the Instrument

⚠️ WARNING

To minimize shock hazard, the instrument chassis and cabinet must be connected to an electrical safety ground. This instrument is grounded through the ground conductor of the supplied, three-conductor AC line power cable. The power cable must be plugged into an approved three-conductor electrical outlet. The power jack and mating plug of the power cable meet IEC safety standards.

⚠️ WARNING

Do not alter or defeat the ground connection. Without the safety ground connection, all accessible conductive parts (including control knobs) may provide an electric shock. Failure to use a properly-grounded approved outlet and the recommended three-conductor AC line power cable may result in injury or death.

⚠️ WARNING

Unless otherwise stated, a ground connection on the instrument's front or rear panel is for a reference of potential only and is not to be used as a safety ground.

Do not operate in an explosive or flammable atmosphere

⚠️ WARNING

Do not operate the instrument in the presence of flammable gases or vapors, fumes, or finely-divided particulates.

⚠️ WARNING

The instrument is designed to be used in office-type indoor environments. Do not operate the instrument

- In the presence of noxious, corrosive, or flammable fumes, gases, vapors, chemicals, or finely-divided particulates.
- In relative humidity conditions outside the instrument's specifications.
- In environments where there is a danger of any liquid being spilled on the instrument or where any liquid can condense on the instrument.
- In air temperatures exceeding the specified operating temperatures.
- In atmospheric pressures outside the specified altitude limits or where the surrounding gas is not air.
- In environments with restricted cooling air flow, even if the air temperatures are within specifications.
- In direct sunlight.

CAUTION

This instrument is intended to be used in an indoor pollution degree 2 environment. The operating temperature range is 0 °C to 40 °C and the operating humidity 90% relative humidity with no condensation allowed.

Measurements made by this instrument may be outside specifications if the instrument is used in non-office-type environments. Such environments may include rapid temperature or humidity changes, sunlight, vibration and/or mechanical shocks, acoustic noise, electrical noise, strong electric fields, or strong magnetic fields.

Do not operate instrument if damaged

WARNING

If the instrument is damaged, appears to be damaged, or if any liquid, chemical, or other material gets on or inside the instrument, remove the instrument's power cord, remove the

instrument from service, label it as not to be operated, and return the instrument to B&K Precision for repair. Notify B&K Precision of the nature of any contamination of the instrument.

Clean the instrument only as instructed

⚠️ WARNING

Do not clean the instrument, its switches, or its terminals with contact cleaners, abrasives, lubricants, solvents, acids/bases, or other such chemicals. Clean the instrument only with a clean dry lint-free cloth or as instructed in this manual.

Not for critical applications

⚠️ WARNING

This instrument is not authorized for use in contact with the human body or for use as a component in a life-support device or system.

Do not touch live circuits

⚠️ WARNING

Instrument covers must not be removed by operating personnel. Component replacement and internal adjustments must be made by qualified service-trained maintenance personnel who are aware of the hazards involved when the instrument's covers and shields are removed. Under certain conditions, even with the power cord removed, dangerous voltages may exist when the covers are removed. To avoid injuries, always disconnect the power cord from the instrument, disconnect all other connections (for example, test leads, computer interface cables, etc.), discharge all circuits, and verify there are no hazardous voltages present on any conductors by measurements with a properly-operating voltage-sensing device before touching any internal parts. Verify the voltage-sensing device is working properly before and

after making the measurements by testing with known-operating voltage sources and test for both DC and AC voltages. Do not attempt any service or adjustment unless another person capable of rendering first aid and resuscitation is present.

Do not insert any object into an instrument's ventilation openings or other openings.

WARNING

Hazardous voltages may be present in unexpected locations in circuitry being tested when a fault condition in the circuit exists.

Fuse replacement

WARNING

Fuse replacement must be done by qualified service-trained maintenance personnel who are aware of the instrument's fuse requirements and safe replacement procedures. Disconnect the instrument from the power line before replacing fuses. Replace fuses only with new fuses of the fuse types, voltage ratings, and current ratings specified in this manual or on the back of the instrument. Failure to do so may damage the instrument, lead to a safety hazard, or cause a fire. Failure to use the specified fuses will void the warranty.

Servicing

CAUTION

Do not substitute parts that are not approved by B&K Precision or modify this instrument. Return the instrument to B&K Precision for service and repair to ensure that safety and performance features are maintained.

Cooling fans

CAUTION

This instrument contains one or more cooling fans. For continued safe operation of the instrument, the air inlet and exhaust openings for these fans must not be blocked nor must accumulated dust or other debris be allowed to reduce air flow. Maintain at least 25 mm clearance around the sides of the instrument that contain air inlet and exhaust ports. If mounted in a rack, position power devices in the rack above the instrument to minimize instrument heating while rack mounted. Do not continue to operate the instrument if you cannot verify the fan is operating (note some fans may have intermittent duty cycles). Do not insert any object into the fan's inlet or outlet.

Use correctly sized wires

WARNING

To connect a load to the power supply, use a wire diameter large enough to handle the maximum continuous output short-circuit current of the power supply without the wire overheating.

For continued safe use of the instrument

- Do not place heavy objects on the instrument.
- Do not obstruct cooling air flow to the instrument.
- Do not place a hot soldering iron on the instrument.
- Do not pull the instrument with the power cord, connected probe, or connected test lead.
- Do not move the instrument when a probe is connected to a circuit being tested.

Compliance Statements

Disposal of Old Electrical & Electronic Equipment (Applicable in the European Union and other European countries with separate collection systems)

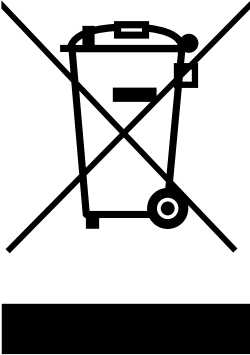

This product is subject to Directive 2002/96/EC of the European Parliament and the Council of the European Union on waste electrical and electronic equipment (WEEE), and in jurisdictions adopting that Directive, is marked as being put on the market after August 13, 2005, and should not be disposed of as unsorted municipal waste. Please utilize your local WEEE collection facilities in the disposition of this product and otherwise observe all applicable requirements.

CE Declaration of Conformity

This instrument meets the requirements of 2006/95/EC Low Voltage Directive and 2004/108/EC Electromagnetic Compatibility Directive with the following standards.











Low Voltage Directive

- EN61010-1: 2001

EMC Directive

- EN 61000-3-2: 2006
- EN 61000-3-3: 1995+A1: 2001+A2: 2005
- EN 61000-4-2 / -3 / -4 / -5 / -6 / -11
- EN 61326-1: 2006

Safety Symbols

	Refer to the user manual for warning information to avoid hazard or personal injury and prevent damage to instrument.
	Electric Shock hazard
	On (Supply). This is the AC mains connect/disconnect switch on the front of the instrument.
	Off (Supply). This is the AC mains connect/disconnect switch on the front of the instrument.
	Direct current
	Alternating current
	Fuse Symbol
	Chassis (earth ground) symbol
	Ground terminal
	Protective earth ground



	CAUTION indicates a hazardous situation which, if not avoided, will result in minor or moderate injury
	WARNING indicates a hazardous situation which, if not avoided, could result in death or serious injury
	DANGER indicates a hazardous situation which, if not avoided, will result in death or serious injury.

Table of Contents

- Safety Summary i**
 - Compliance Statements..... viii
 - Safety Symbols.....x
- 1 General Information 1**
 - 1.1 Product Overview..... 1
 - 1.2 Package Contents 2
 - 1.3 Product Dimensions 3
 - 1.4 Front Panel Overview..... 4
 - Front Panel Description*..... 4
 - 1.5 Keypad Overview 5
 - Keypad Description* 5
 - 1.6 Rear Panel Overview 7
 - Rear Panel Description*..... 7
 - 1.7 Display Overview..... 8
 - Display Description* 8
- 2 Getting Started 9**
 - 2.1 Input Power and Fuse Requirements..... 9
 - Input Power*..... 9
 - Fuse Replacement*..... 12
 - 2.2 Rackmount Installation 12
 - 2.3 Output Connections..... 13

2.4	Preliminary Check	15
	<i>Warm-up Time</i>	15
	<i>Output Check</i>	15
	<i>Check Model and Firmware Version</i>	17
3	Front Panel Operation	19
3.1	Menu Options	19
	<i>How to Access the Menu</i>	20
3.2	Configure Voltage/Current Output	21
	<i>Setting Voltage</i>	21
	<i>Setting Current</i>	22
	<i>Remote Sense</i>	23
3.3	Voltage/Current Measurement.....	25
3.4	System Messages	25
3.5	SYSTEM Menu	27
	<i>Remote Communication Configuration</i>	27
	<i>Save/Recall Instrument Settings</i>	27
	<i>Enable/Disable Key Sound</i>	29
	<i>Restore Factory Default Settings</i>	30
	<i>Configure Power-On State</i>	32
3.6	CONFIG Menu	33
	<i>Output Limit Settings</i>	33
	<i>Protection Settings</i>	35
	<i>External Analog Control</i>	40
	<i>Parallel Operation</i>	53

- 3.7 PV Simulation 57
- 3.8 Program Function..... 60
 - Overview* 60
 - Configure Program Parameters* 61
- 3.9 Timer Function 65
- 3.10 Slew Rate Setting 66
- 4 Remote Operation 67**
 - 4.1 Interface Configuration 67
 - 4.2 Parameter Definition..... 78
 - 4.3 Error/Event List 78
 - 4.4 SCPI Common Commands..... 79
 - 4.5 SCPI Common Subsystem..... 80
 - 4.6 Non-SCPI Remote Commands..... 87
 - 4.7 Multi-Unit Programming Commands..... 88
 - System control commands*..... 88
 - Output control commands*..... 88
 - Synchronous control commands*..... 89
 - Error List*..... 90
 - Status Define*..... 91
- 5 Calibration 92**
 - 5.1 Voltage Calibration 93
 - 5.2 Current Calibration..... 94
 - 5.3 OVP Calibration 96
 - 5.4 OCP Calibration 97

5.5 External Voltage Programming Calibration..... 98

5.6 External Current Programming Calibration..... 99

5.7 CC Calibration of External Voltage 100

5.8 CC Calibration of External Current 101

6 Troubleshooting Guide 103

General 103

Remote Control 104

7 Specifications..... 105

SERVICE INFORMATION 108

1 General Information

1.1 Product Overview

B&K Precision models PVS60085, PVS60085MR, and PVS10005 are high voltage programmable DC power supplies with single outputs that offer the maximum power output up to 5100 watts (0 - 600 V / 8.5 A or 0 - 1000 V / 5 A). By connecting up to 4 power supplies in parallel, a maximum output power can reach up to 20.4 kW. These power supplies are fully programmable and controllable through analog programming, USB, RS232, RS485, GPIB and Ethernet interface. The front numerical keypad and rotary knob provide a convenient interface for adjusting voltage, current, operating functions and enabling/disabling the output. The PVS series power supplies also provide over voltage protection (OVP) and over current protection (OCP) features used to keep the output voltage and current within a specified safety level and preventing damage to the UUT (Unit Under Test).

Features:

- High power output of up to 5100 watts (0-600V/8.5A) (0-1000V/5A)
- USB (virtual COM)/RS232/RS485/Analog/GPIB and Ethernet interfaces
- Parallel connectivity for up to 20.4 kW of power (4 supplies connected in parallel)
- Adjustable voltage and current slope
- 9 user defined programs with up to 100 steps each
- OVP, OCP, OPP, CV to CC, and CC to CV protection
- Store/recall up to 100 sets of voltage/current settings

1.2 Package Contents

Please inspect the instrument mechanically and electrically upon receiving it. Unpack all items from the shipping carton, and check for any obvious signs of physical damage that may have occurred during transportation. Report any damage to the shipping agent immediately. Save the original packing carton for possible future reshipment. Every power supply is shipped with the following contents:

- **1 x PVS10005, PVS60085, or PVS60085MR Power Supply**
- **1 x User Manual**
- **1 x AC Power Cord**
- **1 x Certificate of Calibration**
- **1 x Test Report**

Verify that all items above are included in the shipping container. If anything is missing, please contact B&K Precision.

1.3 Product Dimensions

The PVS10005, PVS60085, and PVS60085MR power supply's dimensions are approximately: 420mm (16.54in) x 88mm (3.46in) x 532mm (20.95in) (WxHxD). These 2U supplies are designed to fit in a standard 19-inch rackmount.

Note: All dimensions in the figures below are measured in millimeters (mm).

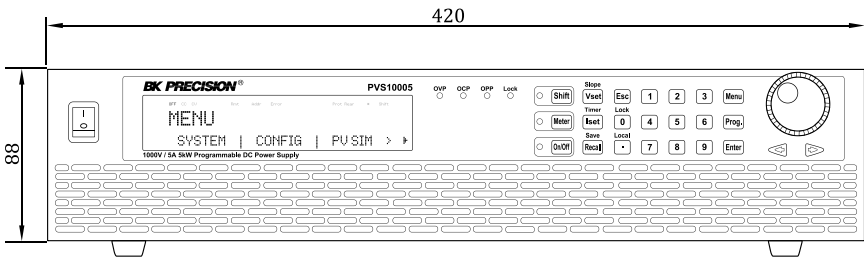

Figure 1.1 – Front Panel Dimensions

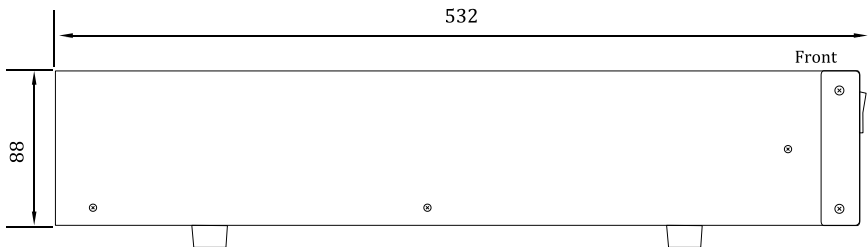

Figure 1.2 – Side Panel Dimensions

1.4 Front Panel Overview

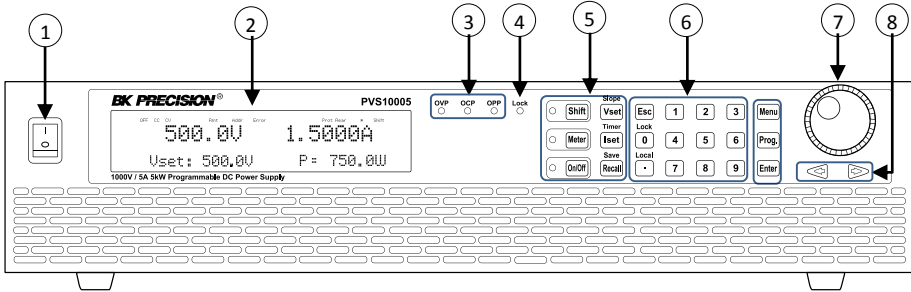

Figure 1.3 – Front Panel Overview

Front Panel Description

- ① Power On/Off switch
- ② Vacuum Fluorescent Display
- ③ OVP, OCP, OPP indicators
- ④ Keypad lock indicator
- ⑤ Function keys
- ⑥ Numeric keys
- ⑦ Rotary Knob
- ⑧ Left, Right cursor keys

1.5 Keypad Overview

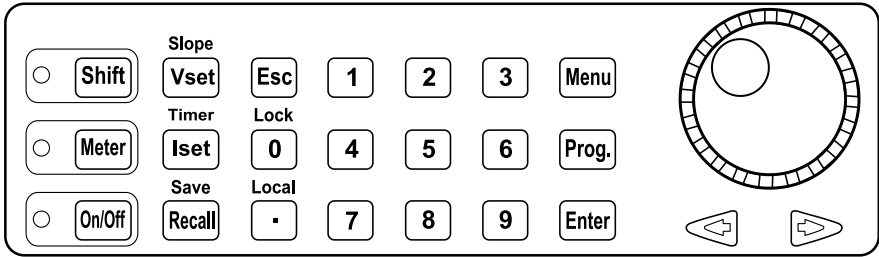

Figure 1.4 – Keypad Overview

Keypad Description



Shift key

Enables access to secondary functions (Labeled in blue)



Meter display button

Toggles display between set and measured voltage and current.



On/Off

Controls the output state.



Vset / Slope button

Configures output voltage or sets the rise and fall times of the output voltage.



Iset / Timer button

Configures output current or setup the timer setting.



Recall / Save button

Saves and recalls instrument settings.



Escape button

Exits menu settings.



Zero / Lock button

Inputs a value of zero or locks the front panel buttons.

Local



Decimal / Local button

Inputs a decimal point for values or sets the instrument back to local mode



Numeric keypad

Enters numeric values for various parameters.



Menu button

Allows access to the power supply menu settings.



Program button

Enters program mode settings menu.



Enter

Confirms setting/parameter changes.



Rotary Knob

Adjusts numeric settings or selects menu items.



Left/Right arrow keys

Adjusts cursor position or select menu items.

1.6 Rear Panel Overview

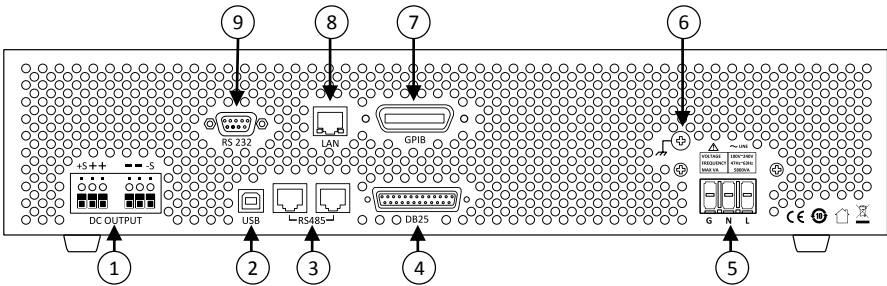

Figure 1.5 – Rear Panel Overview

Rear Panel Description

-
- ① Output and remote sense terminals

 - ② USB interface

 - ③ RS-485 interface

 - ④ Analog programming interface (DB25 connector)

 - ⑤ AC input receptacle

 - ⑥ Earth ground connection

 - ⑦ GPIB interface

 - ⑧ Ethernet (LAN) interface

 - ⑨ RS-232 interface

1.7 Display Overview

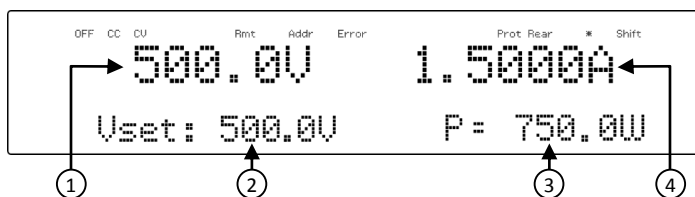

Figure 1.6 – Display Overview

Display Description

①	Set/Measured voltage
②	Settings display <i>Displays parameter settings such as OVP, P-max, Rise/Fall</i>
③	Measured power output
④	Set/Measured current
OFF	Indicates output is disabled
CC	Indicates constant current (CC) operation
CV	Indicates constant voltage (CV) operation
Rmt	Indicates remote mode
Addr	Indicates remote communication activity
Error	Indicates an error has occurred
Trig	Indicates waiting for trigger (for list operation)
Prot	Indicates protection trip for overvoltage or overtemperature
*	Indicates key lock is enabled
Shift	Indicates shift mode (access to secondary button functions)

2 Getting Started

Before connecting and powering up the instrument, please review and go through the instructions in this chapter.

2.1 Input Power and Fuse Requirements

Input Power

The supply has a universal AC input that accepts line voltage input within:

AC Input: **170 V – 265 V (10% output de-rated when operating below 190 VAC)**

Frequency: **47 Hz – 63 Hz**

Before connecting to an AC outlet or external power source, be sure that the power switch is in the OFF position and verify that the AC power cord, including the extension line, is compatible with the rated voltage/current and that there is sufficient circuit capacity for the power supply. When the AC input voltage is lower than the full-load voltage, which is 200VAC, the supplies will activate an inner over temperature protector and cut off the output in response to the condition. To ensure that the entire test process can be completed smoothly, confirm that the input AC voltage is within the specified range. Once verified, connect the cable firmly.

⚠ WARNING

The included AC power cord is safety certified for this instrument operating in rated range. To change a cable or add an extension cable, be sure that it can meet the required power ratings for this instrument. Any misuse with wrong or unsafe cables will void the warranty.

SHOCK HAZARD:

The power cord provides a chassis ground through a third conductor. Verify that your power outlet is of the three-conductor type with the correct pin connected to earth ground.

Follow the instructions below to connect the AC power cable to the AC input of the power supply in the rear panel.

1. First, connect the input receptacle (green terminal block) of the cable to the input terminals of the power supply.
2. Align the power cord housing mounting holes on the left and right side to the screw holes on the power supply.
3. Use only the included screws to fasten and secure the cable housing assembly.

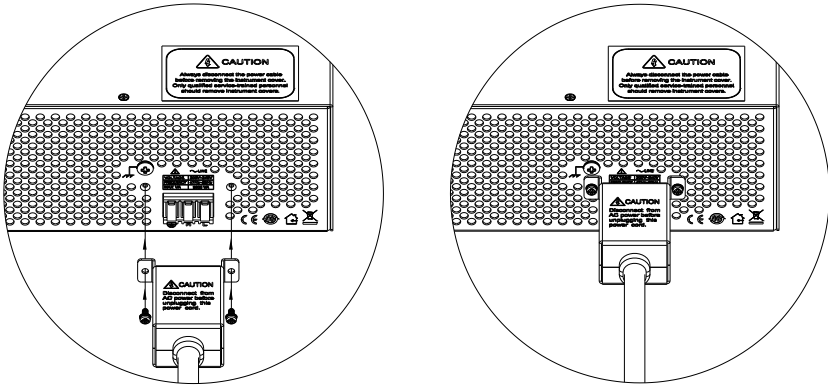

Figure 2.1 – AC Power Connection Diagram

Refer to the descriptions below to connect the other end of the AC power cord to the AC distribution panel.

⚠ WARNING



Do NOT plug the AC power cord into the wall socket prior to connecting ALL three AC power wires to the rear panel and securely mount the safety metal housing over the input receptacle. Doing so may create a shock hazard.

⚠ CAUTION

Connection of this power supply to an AC power source should be made by a qualified electrician or other qualified personnel. Incorrect wiring may damage the power supply or cause a fire hazard

Connect the three terminals black to line (L), white to neutral (N), and green to ground (G) on the other end of the power cord to your AC distribution panel.

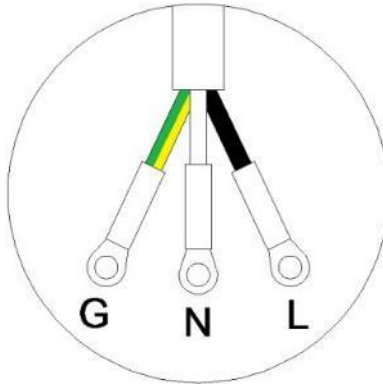

Figure 2.2 – AC Power Cord

Fuse Replacement

This power supply does not require a fuse that is user replaceable. There is an internal fuse, in which if blown, may indicate a malfunction in the unit. In this event, contact B&K Precision.

⚠ WARNING

Any disassembling of the case or changing the fuse not performed by an authorized service technician will void the warranty of the instrument.

2.2 Rackmount Installation

The PVS series power supplies are designed to fit in a space of two rack units (2U) and can be mounted in a standard 19-inch rack panel or

cabinet. Rack mount brackets must be assembled before mounting the unit in a rack. Refer to the following figure to assemble the rack mount brackets.

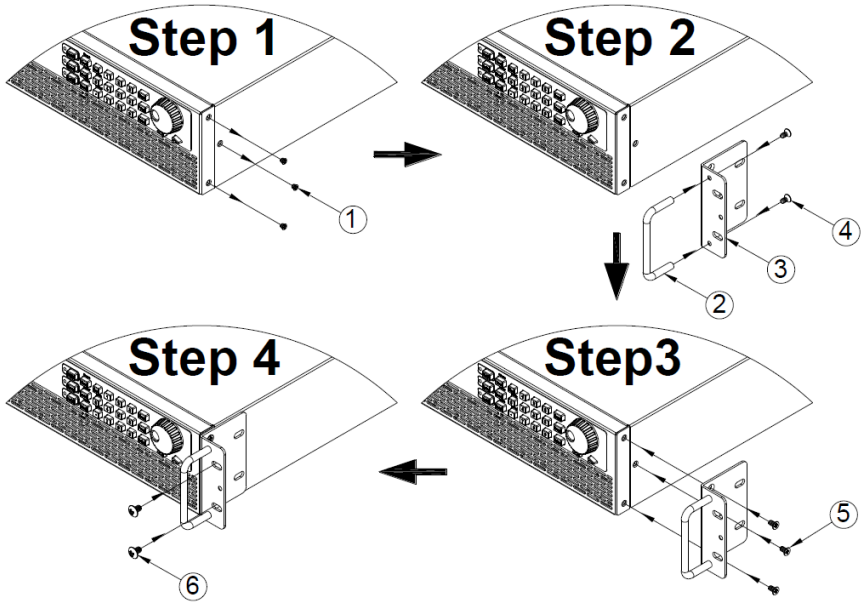

Figure 2.3 – Rack Mount Bracket Assembly

2.3 Output Connections

The main DC output terminal is a screw type terminal block located in the rear panel.

Due to the high current rating of the power supply, proper wire sizes are necessary for safe connectivity and to prevent wires from overheating. Refer to the below table as a reference for proper wire sizes according to the amount of current used for operation:

AWG	6	8	10	12	14	16	18	20	22
I_{max}(A)	75	55	40	25	20	13	10	7	5
mΩ/meter	1.3	2.1	3.3	5.2	8.3	13.2	21	33.5	52.8

Table 1 – Wire Gauge Rating

 WARNING

Before connecting wires to the output terminals, turn OFF the power supply to avoid damage to the instrument and the device under test (DUT). For safety, load wires must have a wire gauge size large enough to prevent overheating when the power supply operates at maximum short circuit output current. It will also prevent large voltage drops from resistances in the wires.

SHOCK HAZARD:



Hazardous voltages may exist at the outputs and the load connections when using a power supply with a rated output greater than 40V. To protect personnel against accidental contact with hazardous voltages, ensure that the load and its connections have no accessible live parts. Ensure that the load wiring insulation rating is greater than to the maximum output voltage of the power supply.

2.4 Preliminary Check

Complete the following steps to verify that the power supply is ready for use.

1. Verify AC input voltage

Verify and check to make sure proper AC voltages are available to power the instrument. The AC voltage range must meet the acceptable specification as explained in “2.1 Input Power and Fuse Requirements”.

2. Connect power

Connect AC power cord to the AC receptacle in the rear panel and press the power switch to the I (ON) position to turn ON the instrument. On power up, the unit will display its model, shown in the screen below, and then check for the optional modules.



B&K Precision
PVS10005

Warm-up Time

The PVS series is fully operable upon switching the power ON. However, to reach the specified equipment accuracy, please allow the supply to warm up for at least 15 minutes.

Output Check

Voltage Check







Follow the steps below to check voltage output with no load connected.

1. Turn ON the power supply. The display will show the **OFF** annunciator above the voltage display.
2. Enable the output by pressing **On/Off**, and the LED next to the button will be lit. The **OFF** annunciator will change to **CV**.
3. Using the numeric keypad or the voltage adjust knob and enter a voltage value. The voltage display will now show the value you entered. If entering with numeric keypad, press **Slope Vset** first, then enter the value and press **Enter**.
4. If the LED next to the **Meter** button is not already lit, press the button once and the voltage display will show the measured voltage at the output, which may fluctuate slightly from the voltage value entered in the previous step.
5. (Optional) You may also verify the output voltage by connecting the (+) and (-) terminals on the rear panel to an external voltmeter. The measured value should match or be within the entered voltage value.

Current Check



Follow the steps below to check current output of the power supply.

1. Turn ON the power supply. The display will show the **OFF** annunciator above the voltage display. Be sure that the output is disabled (the LED next to the **On/Off** button should not be lit when it is off). If the LED is **ON**, press **On/Off** to disable output.
2. Short the (+) and (-) output terminals with test leads, shorting bar, or clip. (Refer to “– Wire Gauge Rating” to select appropriate test leads)

- Using the numeric keypad or the current adjust knob, enter a small current value (i.e. 1.000 A). If entering with numeric keypad, press   first, then enter the value and press . The current display will now show the value you entered.
- Enable the output by pressing , and the LED next to the button will be lit. The **OFF** annunciator will change to **CC**.
- If the LED next to the  button is not already lit, press the button once and the current display will show the measured current at the output, which may fluctuate slightly from the current value entered in step 3.
- (Optional) You may also verify the output current by connecting either the (+) and (-) terminals on the rear panel to an external current meter capable of measuring the current that you set. The measured value should match or be within the entered current value.
- Press the power switch to  (OFF) position to turn off the power supply, then remove the short on the output terminals.

Check Model and Firmware Version

The model and firmware version can be verified by using the ***IDN?** query remote command. It can also be found from within the menu system by following these steps:

- Press  to enter the menu system.
- Press the  button three times until **INFO** is blinking. Press , and the display will show the following screen:

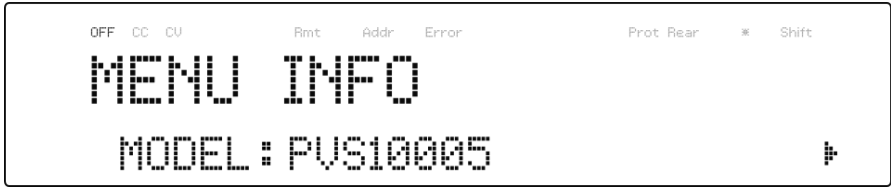

3. The model is shown above as PVS10005.
4. Press  once again and the firmware version will displayed.

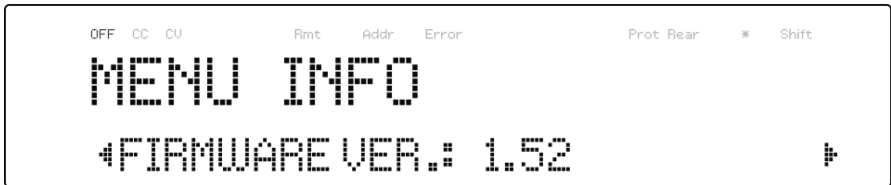

5. The firmware is shown above as 1.52.
6. Press  twice to exit the menu and return to the normal display.

3 Front Panel Operation

3.1 Menu Options

All settings and parameters can be configured from the built-in menu system of the power supply. To access the menu, press .

The menu system is divided into 5 sections and are organized as follows:

SYSTEM

- COMM** Select and configure communication interface.
- MEMORY** Select memory location for save/recall instrument settings.
- BEEP** Enable/Disable key sound.
- DEFAULT** Select memory location for save/recall instrument settings.
- PON STAT** Configure power-on state.

CONFIG

- LIMIT** Configures voltage setting limits.
- PROTECT** Configures OVP, OCP, OPP, CV to CC, and CC to CV protection.
- EXTCTRL** Configures external analog control.
- PARALLEL** Configures parallel connection and master/slave mode.

PV SIM

Configures photovoltaic array simulator function.

INFO





Shows model, firmware version, communications settings, optional modules install and other power supply information.

CAL









Calibration menu.

How to Access the Menu

Before using the instrument, it is important to be familiarized with its menu structure and learn how to view or change settings and parameters. Follow the steps below to guide you in selecting menu options.

1. From the normal display, press  to enter the menu.
2. The selected item will be blinking. Use   keys to move through the menu selections.
3. When the desired menu section is blinking, press  to access its menu settings.
4. Below is the display when **SYSTEM** is selected.



5. The selected item will be blinking. Use the   keys to move through the menu items. When there is a  on the right side of the display, that means there are more menu items available to select from. Similarly, a  will appear on the left side of the display when there are menu items to the left. Use the   keys accordingly to select the desired menu item.
6. Press  to access the selected menu item.
7. There may be parameters or options to select within each menu item. Follow the same instructions as described in the previous steps to select them. To save changes to a setting, press .





8. To exit the menu at any time, press  twice.

3.2 Configure Voltage/Current Output

Voltage and current can be set from the front panel. Remote sense is also available on the rear panel for voltage compensation at the output.

Setting Voltage

Follow the steps below to set the output voltage:

1. From the normal front panel display, users can use either the voltage adjust knob or the numeric keypad to enter the setting voltage.
2. If entering using numeric keypad, press  first so that the cursor selects the voltage display. Then, enter the value and press  to set the voltage.
3. To change the cursor position to adjust with the voltage adjust knob, use the   keys to move left or right.





Note: To see the changes to the setting voltage, be sure the display is not showing the measured voltage. This can be checked by looking at the LED next to the  button. If it is not lit, the display is showing the setting voltage.

When output is ON, the user can use the rotary to adjust the voltage value when the output is in constant voltage (CV) mode. The output value will change simultaneously with the adjusted value. This is so called on-the-fly function that allows user to easily change the output

value if the test is needed.

Setting Current

Follow the steps below to set the output current:

1. From the normal front panel display, users can use either the current adjust knob or the numeric keypad to enter the setting current.
2. If entering using numeric keypad, press  first so that the cursor selects the current display. Then, enter the value and press  to set the current.
3. To change the cursor position to adjust with the voltage adjust knob, use the   keys to move left or right.

Note: To see the changes to the setting current, be sure the display is not showing the measured current. This can be checked by looking at the LED next to the  button. If it is not lit, the display is showing setting current.

When output is ON, the user can use the rotary to adjust the current value when the output is in constant current (CC) mode. The output value will change simultaneously with the adjusted value. This is so called on-the-fly function that allows user to easily change the output value if the test is needed.

Remote Sense

Remote sense can be used to compensate for voltage drops up to 6 V (PVS60085/MR) or 10 V (PVS10005) due to resistance from test leads connected to your device under test (DUT), thus providing more accurate output voltage. The power supply is initially set up for local sense mode by default. Refer to the following sections for details of local and remote sense setup.

Local Sense

By default, the power supply is set up for local sense. This is determined by the wire connections in the rear panel, illustrated below:

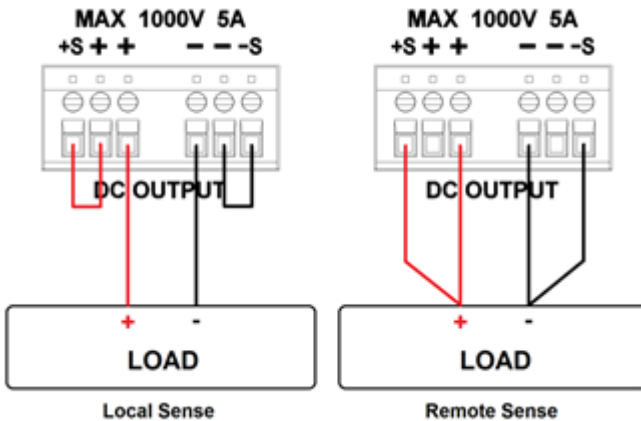

Figure 3.1 – Local/Remote Sense Connection Diagram

When local sense is selected, the positive sense (+S) is connected to the positive lead (+) and negative sense (-S) is connected to the negative lead (-), whereas the positive lead (+) of the DC output is connected to the positive end (+) of the load and the negative lead (-) of the DC

output is connected to the negative end (-) of the load. When this sensing mode is selected the wires connecting between DC outputs to the load must be as short as possible. The local sense is the default configuration with shorting bars connect between (+S) to (+) and (-S) to (-).

⚠ WARNING

DO NOT disconnect the wires if remote sense is not used. Doing so will cause erratic behavior and may damage the power supply under certain conditions.



Never connect any power source into any of the four terminals at any time during operation.

When output is enabled, DO NOT use your hands to touch the terminals or the screws that are designed to tighten wires to the terminals. Doing so may create a shock hazard under high voltage output conditions.

Remote Sense

When remote sense is selected, the positive sense (+S) and positive lead (+) of the DC output are connected to the positive end (+) of the load, whereas negative sense (-S) and negative lead (-) of the DC output are connected to the negative end (-) of the load.

To enable remote sense, follow the steps below:

1. Power OFF the supply and disconnect all loads and cables connected to it.

2. Use a small flat blade screwdriver to loosen the wire connection connected between **Vo+ and S+** and **S- and Vo-**.
 3. Connect the **S+** to the DUT's positive (+) terminal, and connect the **S-** to the DUT's negative (-) terminal.
 4. Do not connect any wires to **Vo+** and **Vo-** terminals.
 5. Power ON the power supply, and then configure and enable the output. The setup should look like the figure above.
-

CAUTION

DO NOT at any time disconnect the wires from the Vs+ and Vs- terminals to the DUT while output is enabled (ON). Doing so may damage the power supply and cause unstable output.

3.3 Voltage/Current Measurement

The display will show the set voltage and current values or the measured values of the output. To toggle this reading, press  key. When the Meter LED indicator is on, the display shows the measured voltage and current values. When the Meter LED indicator is off, the display shows the set voltage and current values.

3.4 System Messages

The PVS has built-in sensors to detect system conditions. If a fault status occurred, the error message will show on the display and automatically protect the power supply output. The following display occurs when the fan has failed or stopped turning:

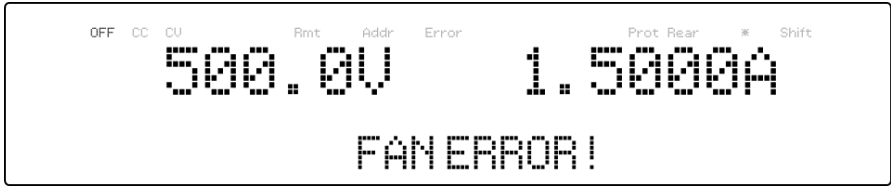

The following table shows the various messages that may alert the user:

System message	Description
IAC TOO HIGH!	AC input current too high
VBUS NO CHARGE!	Internal PFC VBUS is not charged
VAC TOO LOW!	AC input voltage too low
VAC TOO HIGH!	AC input voltage too high
MEMORY CHECK ERROR!	Cannot read or write the internal non-volatile memory
OVER TEMPERATURE PROTECTION!	Internal temperature is too high and the protection mechanism is activated
FAN ERROR!	FAN not functioning
EXCEED OVP!	Output voltage exceeds maximum OVP setting point
EXCEED OCP!	Output current exceeds maximum OCP setting point
CALIBRATION ERROR!	Calibration cannot be done
AC FREQUENCY ERROR!	AC input frequency is out of range
PFC ERROR!	PFC not functioning correctly
POWER OFF	Power supply is powering off

3.5 SYSTEM Menu

All setup procedures and settings explained in this section can be accessed from the **SYSTEM** menu. To access this menu, press .

When **SYSTEM** is blinking, press .



Remote Communication Configuration

To set up remote interface connections and settings, refer to chapter “4 Remote Operation”.

Save/Recall Instrument Settings

The instrument can save up to 100 voltage/current values for quick recall access. Memory is allocated in 10 different storage groups (group 0 to 9), and each group has 10 memory locations to store settings (0 to 9). The memory group must be selected from the menu first, before settings can be saved within the group.

Select Storage Group

1. From the **SYSTEM** menu, press  button 1 time to select **Memory** and press . The following screen will appear.



- Use the rotary knob or the numeric keypad to enter the storage group. Select between **0 – 9**. Press **Enter** to save selection.
- To exit the menu at any time, press **Esc** twice.

Save Settings

- Set up output voltage and current settings that you want to save.
- Then, press **Shift** and **Recall**. The display will show the following:



- Use the current adjust knob or the numeric keypad to enter the memory location in which to store current instrument settings. Select between **0 – 9**. Press **Enter** to save to the selection location.

Recall Settings

- Press **Recall** to enter the **Recall** mode. The current group number is shown on the display.



Instrument settings can only be recalled when the instrument enters this mode.





2. Use the keypad to enter the memory location you want to recall. Enter between **0 – 9**. The voltage and current settings of that memory location will be shown on the bottom of the display.
3. Once entered, the saved settings at the location will be immediately recalled.

Note: When in Recall mode, users can recall settings from different locations without having to press additional keys each time. For example, you can press 1 to recall settings in location one, and then press 5 to immediately recall settings in location 5.

4. To exit **Recall** mode, press .

Enable/Disable Key Sound

The instrument initially has key sound enabled from factory. To disable or re-enable the key sound, follow the steps below:

1. From the **SYSTEM** menu, press  button 2 times to select **BEEP** and press .
2. Select between the two options using the rotary knob:
On – Enable key sound
Off – Disable key sound
3. Select the desired option and press  to save the change.
4. To exit the menu at any time, press  twice.

Restore Factory Default Settings

All instrument settings can be reset back to their factory default values by doing the following:

Note: Restoring the instrument to factory default will change all current instrument settings and parameters back to their default values.



1. From the **SYSTEM** menu, press  button 3 times to select **DEFAULT** and press .
2. The instrument will return to the normal display and all settings are now restored back to factory default. The table below lists some of the factory default settings.

Table 2 - Factory Default Settings



Item	Parameter	PVS60085/MR	PVS10005
Output	Voltage	10.0 V	10.0 V
	Current	1.0000 A	1.0000 A
	State	OFF	OFF
Protection	OVP, OVP Voltage	OFF, 660.0 V	OFF, 1100.0 V
	OCP, OCP Current	OFF, 8.670 A	OFF, 5.100 A
	OPP, OPP Power	OFF, 5302.5 W	OFF, 5200.5 W
	CV to CC	OFF	OFF



	CC to CV	OFF	OFF
Slope	Voltage	6 V/ms	4 V/ms
	Current	85 mA/ms	20 mA/ms
Parallel	Mode	OFF	OFF
	Role	MASTER	MASTER
External Control	Enable	NOT ACTIVE	NOT ACTIVE
	Voltage	FRONT	FRONT
	Current	FRONT	FRONT
	Program range	5V/5k Ω	5V/5k Ω
	Monitor range	5 V	5 V
	Shut off logic	OFF/LOW	OFF/LOW
Beep	Mode	OFF	OFF
Limit	VMAX	606.0 V	1010.0 V
	VMIN	5.0 V	5.0 V
	IMAX	8.585 A	5.050 A
	IMIN	0.034 A	0.020 A

GPIB	Address	1	1
RS-232C	Baud, parity, data, stop	9600, N, 8, 1	9600, N, 8, 1
RS-485	Baud, parity, data, stop	9600, N, 8, 1	9600, N, 8, 1
	Address	1	1
LAN	Mode	AUTO	AUTO
	IP address	0.0.0.0	0.0.0.0
	Mask address	0.0.0.0	0.0.0.0
	Gateway address	0.0.0.0	0.0.0.0



Configure Power-On State

The initial Power-On state of the power supply can be configured (voltage, current, output state) by following the steps below:

1. From the **SYSTEM** menu, press  button 4 times to select **PON STAT** and press .
2. There are three options which can be selected using the rotary knob:
 - OFF** – Last voltage and current values before power off and output state is OFF.
 - LAST** – Last voltage, current, and output state values before power OFF.
 - USER** – User defined voltage, current, and output state.

3. Select one of the settings wanted during power up, and press  to save changes. If **USER** has been selected, set user defined voltage, current and output state.
4. To exit the menu at any time, press  twice.

3.6 CONFIG Menu

All setup procedures and settings explained in this section can be accessed from the **CONFIG** menu. To access this menu, press , press  1 time and select **CONFIG**, then press .

Output Limit Settings

The voltage or current output limits can be configured to provide limit protection to prevent accidental changes to the output settings. There are four limit values that can be set: voltage maximum (VMAX), voltage minimum (VMIN), current maximum (IMAX), and current minimum (IMIN).

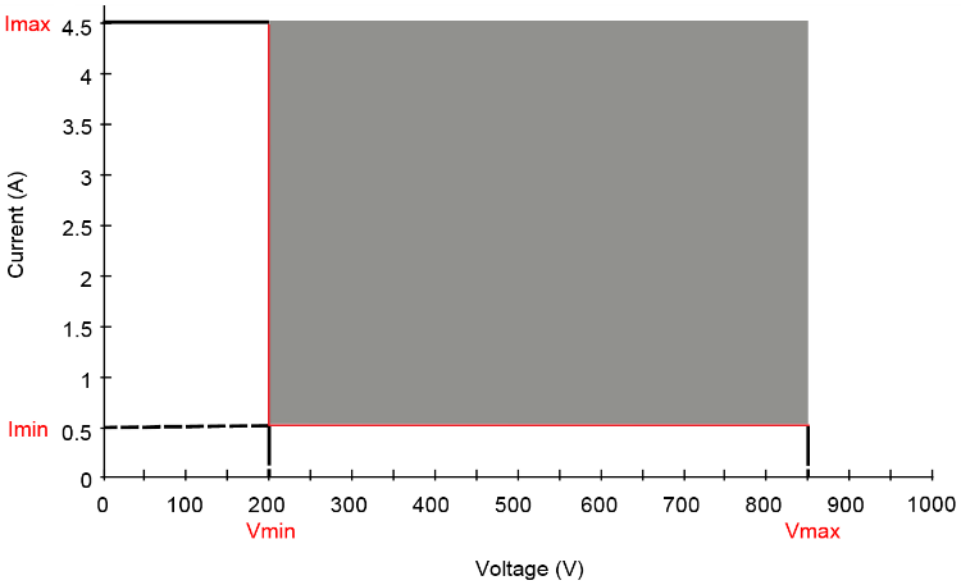

Figure 3.2 – Output Limit Settings Graph





Note: At any time during operation, when you are unable to set to a desired voltage or current, check these limit settings to make sure the set value is within the limit's range.

The shaded area illustrated above is the settable range of the output voltage and current.

Follow the steps below to configure the output limits:

1. From the **CONFIG** menu, select **LIMIT**, then press **Enter**. The following screen will display:









2. Use the   keys to select the limit setting value of VMAX, VMIN, IMAX, and IMIN. Press  to confirm selection.
3. Use the numerical keys to set the limit value and press  to confirm the setting.
4. Press  several times to exit the menu setting.





Protection Settings

Configure Over Voltage Protection (OVP)

The PVS overvoltage protection utilizes a hardware comparator that quickly protects the instrument when the voltage presented at the output terminal exceeds the OVP setting voltage.

Follow the steps below to set the OVP limit:

1. Press the  button and press the  button one time until **CONFIG** is blinking and press .
2. Press  button one time until **PROTECT** is blinking and press . The display will then show **OVP**.
3. Use rotary to select the OVP ON or OFF followed by .

4. Use numerical keys directly or use   keys with rotary adjustment followed by  to confirm the OVP value.
5. Press  several times to exit the menu setting.
6. If the OVP is on, the OVP LED indicator will be lit up.

When OVP protection is tripped during operation, the output will turn off and the following OVP status message will display:

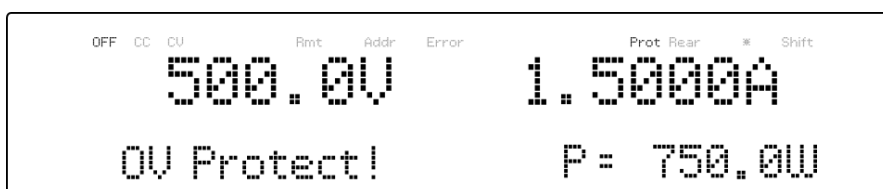











To clear the trip status, press  once.

Configure Over Current Protection (OCP)

The PVS overcurrent protection utilizes a hardware comparator that quickly protects the instrument when the current presented at the output terminal exceeds the OCP setting current.

Follow the steps below to set the OCP limit:

1. Press the  button and press the  button one time until **CONFIG** is blinking and press .
2. Press  button one time until **PROTECT** is blinking and press . The display will then show **OVP**.
3. Press  button one time until **OCP** is displayed.

4. Use rotary to select the OCP ON or OFF followed by .
5. Use numerical keys directly or use   keys with rotary adjustment followed by  to confirm the OCP value.
6. Press  several times to exit the menu setting.
7. If the OCP is on, the OCP LED indicator will be lit up.

When OCP protection is tripped during operation, the output will turn off and the following OCP status message will display:

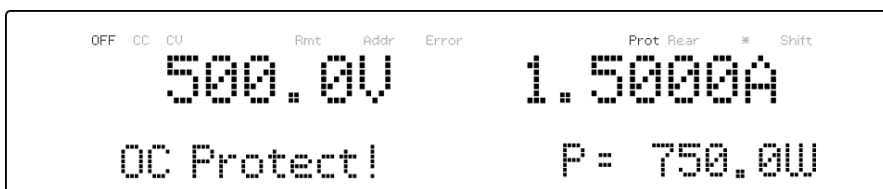









To clear the trip status, press  once.

Configure Overpower Protection (OPP)

The PVS overpower protection continuously monitors the output power level. If it is greater than the OPP setting, it turns off the power supply output to protect the device under test.

Follow the steps below to set the OPP limit:

1. Press the  button and press the  button one time until **CONFIG** is blinking and press .
2. Press  button one time until **PROTECT** is blinking and press . The display will then show **OVP**.
3. Press  button two times until **OPP** is displayed.

4. Use rotary to select the OPP ON or OFF followed by **Enter**.
5. Use numerical keys directly or use   keys with rotary adjustment followed by **Enter** to confirm the OPP value.
6. Press **Esc** several times to exit the menu setting.
7. If the OPP is on, the OPP LED indicator will be lit up.

When OPP protection is tripped during operation, the output will turn off and the following OPP status message will display:

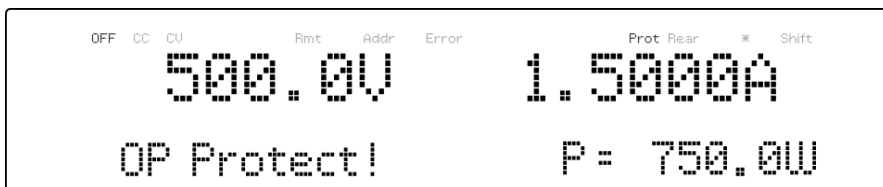



To clear the trip status, press **Esc** once.

Configure CV to CC Protection

The PVS CV to CC protection monitors the transition between constant voltage to constant current mode. If this event occurs, the output of the power supply will turn off.

Follow the steps below to set the CV to CC limit:

1. Press the **Menu** button and press the  button one time until **CONFIG** is blinking and press **Enter**.
2. Press  button one time until **PROTECT** is blinking and press **Enter**. The display will then show **OVP**.
3. Press  button three times until **CV to CC** is displayed.

4. Use rotary to select the OPP ON or OFF followed by **Enter**.
5. Press **Esc** several times to exit the menu setting.

When CV to CC protection is tripped during operation, the output will turn off and the following CV to CC status message will display:



To clear the trip status, press **Esc** once.

Configure CC to CV Protection

The PVS CC to CV protection monitors the transition between constant current to constant voltage mode. If this event occurs, the output of the power supply will turn off.

Follow the steps below to set the CV to CC limit:

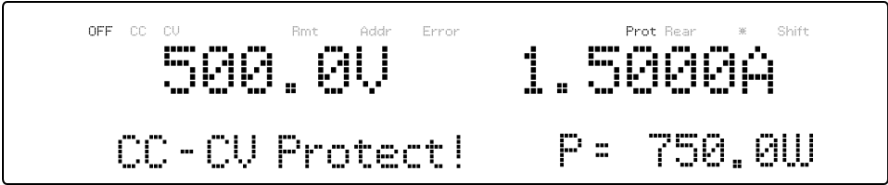

1. Press the **Menu** button and press the **▶** button one time until **CONFIG** is blinking and press **Enter**.
2. Press **▶** button one time until **PROTECT** is blinking and press **Enter**. The display will then show **OVP**.
3. Press **▶** button four times until **CC to CV** is displayed.
4. Use rotary to select the CC to CV ON or OFF followed by **Enter**.
5. Press **Esc** several times to exit the menu setting.

When CC to CV protection is tripped during operation, the output will turn off and the following CC to CV status message will display:





To clear the trip status, press  once.

External Analog Control

To control or monitor the output of the power supply using external signals, refer to the following figure of the DB25 connector located in the rear panel. The logical signal  is a TTL compatible signal. The analog signal  cannot exceed the range of 0 to 12VDC.

WARNING

DO NOT exceed 12VDC on any of the analog signal  pins or TTL voltage on any of the logical signal  pins of the DB25 connector. Doing so will cause erratic behavior and may damage the power supply under certain conditions.

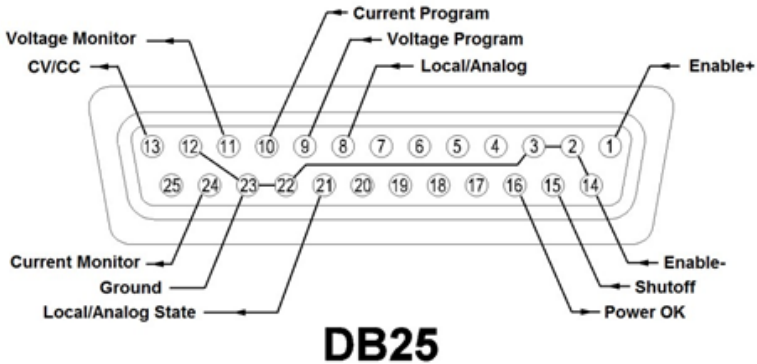

DB25
Figure 3.3 – DB25 Pinout



Pin	Signal		I/O	Description
1	Enable+	Ⓛ	I	Open: AMODE, output <input type="button" value="On/Off"/> button is disabled BMODE, output is OFF
				Short to Enable: AMODE, output <input type="button" value="On/Off"/> button is enable BMODE, output is ON
2	Ground			
3	Ground			
8	Local/Analog	Ⓛ	I	Open: front panel control
				Short to ground: rear analog control

9	Voltage Program	Ⓐ	I	Input 0-5 V / 0-5 kΩ or 0-10 V / 0-10 kΩ for voltage output setting, full scale input equals maximum output voltage
10	Current Program	Ⓐ	I	Input 0-5 V / 0-5 kΩ or 0-10 V / 0-10 kΩ for current output setting, full scale input equals maximum output current
11	Voltage Monitor	Ⓐ	O	Output 0-5 V / 0-10 V represents power supply output voltage, full scale output equals maximum output voltage
12	Ground			
13	CV/CC	Ⓛ	O	High: constant voltage
				Low: constant current
14	Enable- (Ground)			
15	Shutoff	Ⓛ	I	Low to High: OFF/LOW, no action ON/LOW, output is off
				High to Low: OFF/LOW, output is off ON/LOW, no action
16	Power OK	Ⓛ	O	High: output is ON
				Low: output is OFF

21	Local/Analog State	Ⓛ	0	High: front panel controlled
				Low: rear analog controlled
22	Ground			
23	Ground			
24	Current Monitor	Ⓐ	0	Output 0-5 V / 0-10 V represents power supply output current, full scale input equals maximum output current



Enabling/Disabling External Control





Follow the steps below to configure and enable the external control interface.

1. Press the **Menu** button and press the  button one time until **CONFIG** is blinking and press **Enter**.
2. Press  button three times until **EXTCTRL** is blinking and press **Enter**. Press **Enter** once again to select **ENABLE**.
3. Use the rotary knob to select the setting of **ACTIVE-AMODE** or **ACTIVE-BMODE** from **NOT ACTIVE** and press **Enter**. If the enable is set to **NOT ACTIVE**, all the external control as well as the analog program control will be disabled.
4. Press **Esc** several times to exit the menu setting.

AMODE

This mode allows **On/Off** button to be output ON/OFF control. When

Enable+ (Pin 1) and Enable- (Pin 14) are opened, the  button is disabled and the power supply's output will remain OFF. Pressing the  button will not turn ON the output, and the display will also show **ENA**.

When Enable+ (Pin 1) and Enable- (Pin 14) are shorted, the  button is enabled. This will enable the  button to allow front panel control of the output state. If the **ENA** is shown on the LCD screen, press  once so that it disappears before attempting to press the  button.

BMODE

This mode allows enabling or disabling the power supply's output using the Enable+ (Pin 1) and Enable- (Pin 14). It will also disable the  button.

When Enable+ (Pin 1) and Enable- (Pin 14) are opened, the output is OFF.

When Enable+ (Pin 1) and Enable- (Pin 14) are shorted, the output is ON.

EXTCTRL ENABLE	Enable+ (pin1) / Enable- (pin14)	 button	Output	Display
NOT ACTIVE	Not Active	Enable	ON/OFF	---
ACTIVE - AMODE	Opened	Disable	OFF	ENA
	Shorted	Enable	ON/OFF	---

ACTIVE - BMODE	Opened	Disable	OFF	---
	Shorted	Disable	ON	---

Local/Analog Control

Pin 8 can be used to select the control mode (local or analog) of the power supply’s output. When the input command for this pin is at high level (or open), the control mode will be local. When input command for this pin is at low level (or shorted to GND), the control mode will be analog. The following table shows the various configurations:

EXTCTRL ENABLE	EXTCTRL VOLTAGE / CURRENT	Local/Analog (Pin 8)	Output Control	Display
NOT ACTIVE	FRONT	High (Open)	Local	---
		Low(Short)	Local	---
	EXT-V or EXT-R	High(Open)	Local	---
		Low(Short)	Local	---
ACTIVE	FRONT	High(Open)	Local	---
		Low(Short)	Local	---
	EXT-V or EXT-R	High(Open)	Local	---
		Low(Short)	Analog	---

Local/Analog State

Pin 21 is used to indicate the current output control mode of the power supply (local or analog state). In local state, this pin will output a high level (5V) signal, and in analog state, this pin will output a low level (0V) signal.

Power OK Signal



Pin 16 is used to indicate whether a fault condition is present in the power supply. Normally this pin will output a logic high (5V). When a fault occurs, this pin will output a logic low (0V).











Fault conditions are defined as follows:

1. Overvoltage protection
2. Overcurrent protection
3. Overpower protection
4. CV to CC protection
5. CC to CV protection
6. Overtemperature protection
7. AC line failure
8. Enable signal
9. Shutoff signal
10. Remote failure
11. Output off

Voltage Program

This function is able to program the voltage output by connecting an external DC voltage (voltage mode) or an external resistor (resistor mode) to Pin 9. For this function to be enabled, the output control must be in analog mode. The external voltage range or resistor range used to control the full scale of the output voltage can be selected between 0-5 V / 0-5 k Ω and 0-10 V / 0-10 k Ω range. Follow the steps below to configure the voltage program.

1. Press the  button and press the  button one time until **CONFIG** is blinking and press .

2. Press  button three times until **EXTCTRL** is blinking and press .
3. Press  button one time to select **VOLTAGE** and press .
4. Use the rotary knob to select **EXT-V** (external voltage) or **EXT-R** (external resistance) option and press . To have front panel control, select **FRONT**.
5. Use the   keys to select **PROG RNG** (program range) and press .
6. Now use the rotary knob to select between **10V/10K** or **5V/5K** and press .
7. Press  several times to exit the menu setting.

Voltage Mode

Under voltage mode, the user may control the full scale output voltage value through Pin 9, by inputting a voltage level of 0-5 V (0-5 V / 0-5 k Ω mode) or 0-10 V (0-10 V / 0-10 k Ω mode) as shown below.

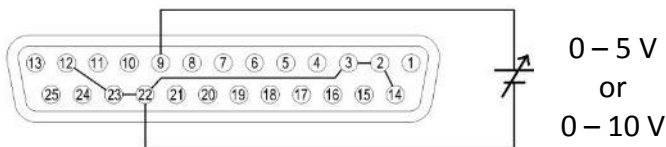

Figure 3.4 – Analog Voltage Programming Diagram (Voltage Mode)

Resistor Mode

Under resistor mode, the user may control the full scale voltage output

value by connecting a resistance value of 0-5 kΩ (0-5 V / 0-5 kΩ mode) or 0-10 kΩ (0-10 V / 0-10 kΩ mode) between Pin 9 and Pin 22 as shown below.

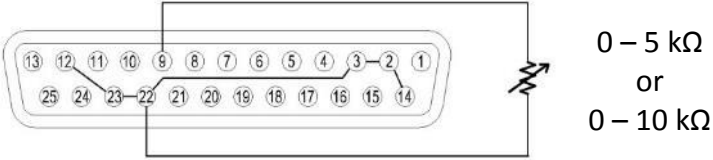







Figure 3.5 - Analog Voltage Programming Diagram (Resistor Mode)

Current Program

This function is able to program the current output by connecting an external DC voltage (voltage mode) or an external resistor (resistor mode) to Pin 10. For this function to be enabled, the output control must be in analog mode. The external voltage range or resistor range used to control the full scale of the output voltage can be selected between 0-5 V / 0-5 kΩ and 0-10 V / 0-10 kΩ range. Follow the steps below to configure the voltage program.

1. Press the **Menu** button and press the  button one time until **CONFIG** is blinking and press **Enter**.
2. Press  button three times until **EXTCTRL** is blinking and press **Enter**.
3. Press  button two times to select **CURRENT** and Press **Enter**.
4. Use the rotary knob to select **EXT-V** (external voltage) or **EXT-R**(external resistance) option and press **Enter**. To have front panel control, select **FRONT**.
5. Use the   keys to select **PROG RNG** (program range) and press **Enter**.

6. Now use the rotary knob to select between **10V/10K** or **5V/5K** and press **Enter**.
7. Press **Esc** several times to exit the menu setting.

Voltage Mode

Under voltage mode, the user may control the full scale current output value through Pin 10, by inputting a voltage level of 0-5V (0-5 V / 0-5 k Ω mode) or 0-10V (0-10 V / 0-10 k Ω mode) as shown below.

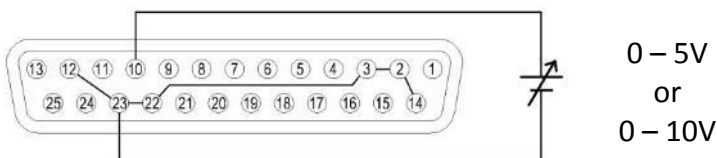

Figure 3.6 - Analog Current Programming Diagram (Voltage Mode)

Resistor Mode

Under resistor mode, the user may control the full scale current output value by connecting a resistance value of 0-5 k Ω (0-5 V / 0-5 k Ω mode) or 0-10 k Ω (0-10 V / 0-10 k Ω mode) between Pin 10 and Pin 23 as shown below.

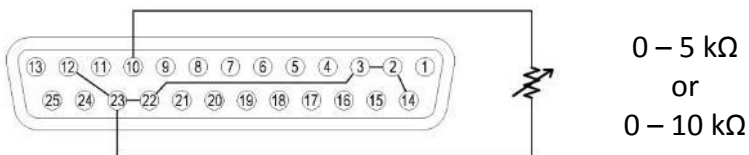

Figure 3.7 - Analog Current Programming Diagram (Resistor Mode)

Voltage Monitor

This function is able to monitor the voltage output using Pin 11 and one of the ground pins (i.e. Pin 22), which can be connected to a digital voltage meter (DVM) or other voltage monitoring device, as shown below. The output control must be in analog mode to use this function. The monitoring of the output voltage range (which reflects 0 to full scale of the power supply's output voltage) can be selected between 0-5 V and 0-10 V.

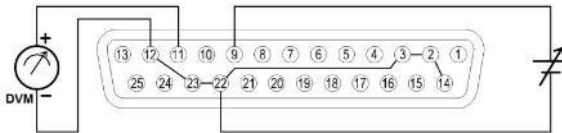

Figure 3.8 - Analog Voltage Monitor Diagram

Follow the steps below to configure the voltage program.

1. Press the **Menu** button and press the **▶** button one time until **CONFIG** is blinking and press **Enter**.
2. Press **▶** button three times until **EXTCTRL** is blinking and press **Enter**.
3. Press **▶** button four times to select **MON RNG** and Press **Enter**.
4. Now use the rotary knob to select **5V** or **10V** and press **Enter**.
5. Press **Esc** several times to exit the menu setting.

Current Monitor

This function is able to monitor the voltage output using Pin 24 and one

of the ground pins (i.e. Pin 23), which can be connected to a digital voltage meter (DVM) or other voltage monitoring device, as shown below. The output control must be in analog mode to use this function. The monitoring of the output voltage range (which reflects 0 to full scale of the power supply's output voltage) can be selected between 0-5 V and 0-10 V.

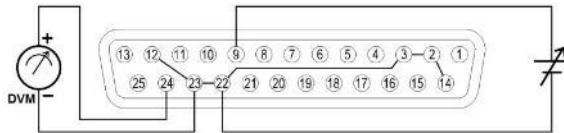

Figure 3.9 - Analog Current Monitor Diagram



Follow the steps below to configure the voltage program.

1. Press the **Menu** button and press the **▶** button one time until **CONFIG** is blinking and press **Enter**.
2. Press **▶** button three times until **EXTCTRL** is blinking and press **Enter**.
3. Press **▶** button four times to select **MON RNG** and Press **Enter**.
4. Now use the rotary knob to select **5V** or **10V** and press **Enter**.
5. Press **Esc** several times to exit the menu setting.

Shut Off Control

Shut off control allows Pin 15 of the DB25 interface to be used to shut off the power supply's output, which is controlled by an input trigger signal. The output shuts off with the falling or rising edge of the trigger.

Follow the steps below to configure the shut off control.

1. Press the **Menu** button and press the  button one time until **CONFIG** is blinking and press **Enter**.
2. Press  button three times until **EXTCTRL** is blinking and press **Enter**.
3. Press  button five times to select **SHUT OFF** and Press **Enter**.
The following will be on the display:



4. Use the rotary knob to select the setting of **OFF/Low** (Falling Edge) or **ON/Low** (Rising Edge) and press **Enter**.
5. Press **Esc** several times to exit the menu setting.

When shut off occurs, the output will be turned off immediately and **SO** will appear on the display as shown below. To enable the output again, first set (Pin 15) input voltage back to the original voltage setting (for falling-edge trigger, set back to high level (5V), and low level (0 V) for rising-edge trigger). Then, press **Esc** (to deactivate the **SO** status) before pressing **On/Off** button again to enable the output.

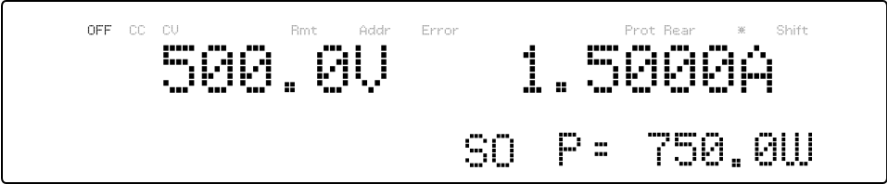

Note: Shut off can only occur when the power supply receives an edge trigger. Maintaining that pin constantly at a high level or low level will not trigger a shut off.

EXTCTRL ENABLE	EXTCTRL SHUT-OFF	Shutoff (Pin 15)	Output	Display
NOT ACTIVE	OFF/Low	Not Active	ON/OFF	---
	ON/Low	Not Active	ON/OFF	---
ACTIVE	OFF/Low	High to low	OFF	SO
	ON/Low	Low to High	OFF	SO

Parallel Operation

Connection and Setup

The PVS power supplies can be connected in parallel to increase the power output capability as well as the output current. Up to four units of the same model can be connected for output up to 20,400 W (max). To connect four units in parallel, follow the diagram shown below:

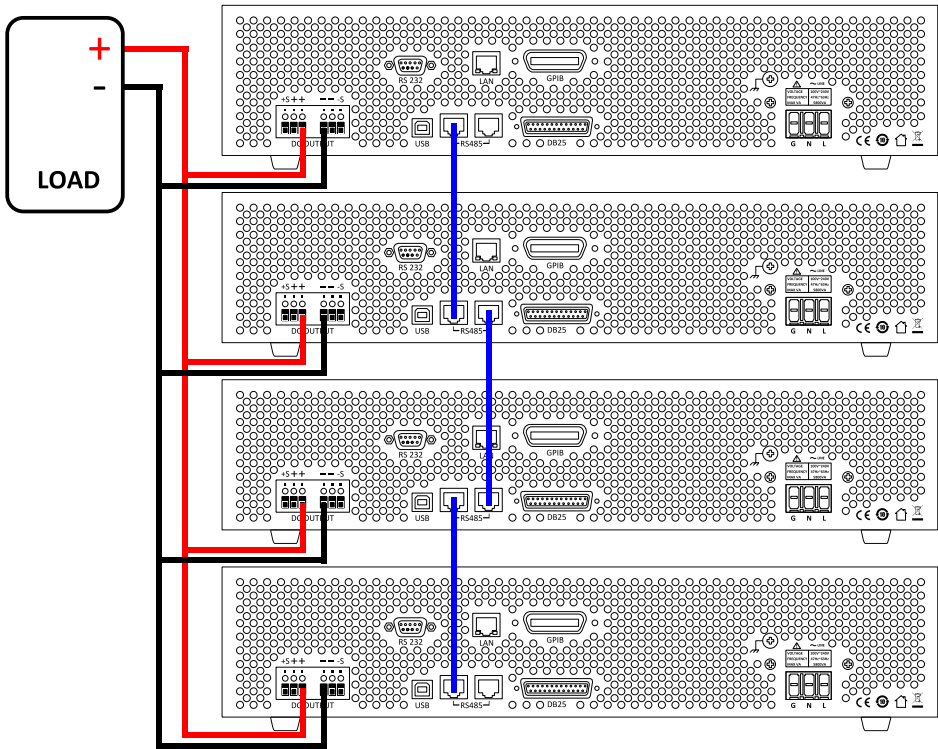











Figure 3.10 – Parallel Connection Diagram

After wiring is complete, configure one of the supplies as the Master and the other three as Slave A, B, and C. After one of the supplies is configured to be the Master, it will start searching for all Slaves that are connected to the Master. To operate correctly, the user must set up the Slaves before the Master. Follow the steps below to set a supply to master or slave mode.

1. Press the **Menu** button and press the  button one time until **CONFIG** is blinking and press **Enter**.

2. Press  button four times until **PARALLEL** is blinking and press .
3. Press  to select the parallel **MODE**.
4. Use the rotary knob to select the setting of **OFF** or **ON** and press .
5. Press  button one time until **ROLE** is blinking and press .
6. Use the rotary knob to set the master or slave and press . Use the same procedure to set up **MASTER**, **SLAVE A**, **SLAVE B**, or **SLAVE C** for the other power supplies.
7. Press  several times to exit the menu setting.

Slave Unit

When a power supply is set up to be a slave unit, it will wait for the master's connection, as shown below.



If the master unit has found the slave unit, the slave unit will be controlled by the master unit and the following will be displayed:

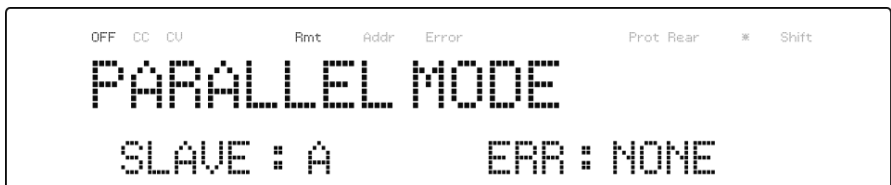

In parallel mode, the slave unit is remote controlled by the master unit.

The keypad will be locked. To exit the parallel mode, press  key to access the parallel mode ON/OFF setting in the menu. Turn off to disable parallel mode control.

Master Unit

After all of the slave units have been set, the master unit can be set by the same procedure with the role set to **MASTER**. As shown below, the master unit will start to search for the slave units.



After the search is completed, the master will show how many slave units have been found, as shown in the following display:



Press  to confirm the slave units and parallel mode operation. The following screen should be displayed.

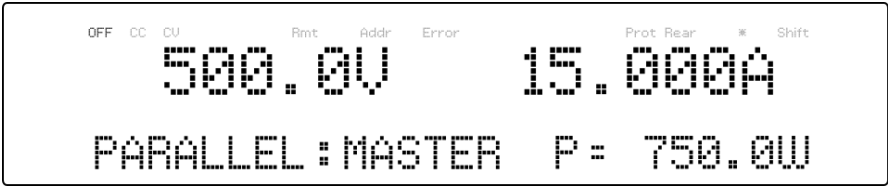

⚠ CAUTION

While in parallel connection mode, the output voltage of each power supply should be set to equal value. If the voltage value of each unit is not the same, the higher output voltage will feed back to the lower voltage unit and damage its internal components.

Do not connect multiple power supplies in series as it may cause damage or malfunction.

3.7 PV Simulation

Typically, a solar array is connected to an inverter, which converts the panel's output from DC to AC. Due to varying environmental conditions and the nonlinear output of solar cells, many inverters use a maximum power point tracking mechanism to maximize the power generated from the solar panel. Using an actual solar array to test inverters is not cost-effective and environmental conditions are difficult to control in this scenario.

The PVS power supply can simulate the output of a solar array with its solar array simulator (SAS) function. Combined with the PVS SAS application software, users can simulate the I-V curve of different arrays under various irradiance conditions while measuring and validating the

effectiveness of the inverter's MPPT algorithm.

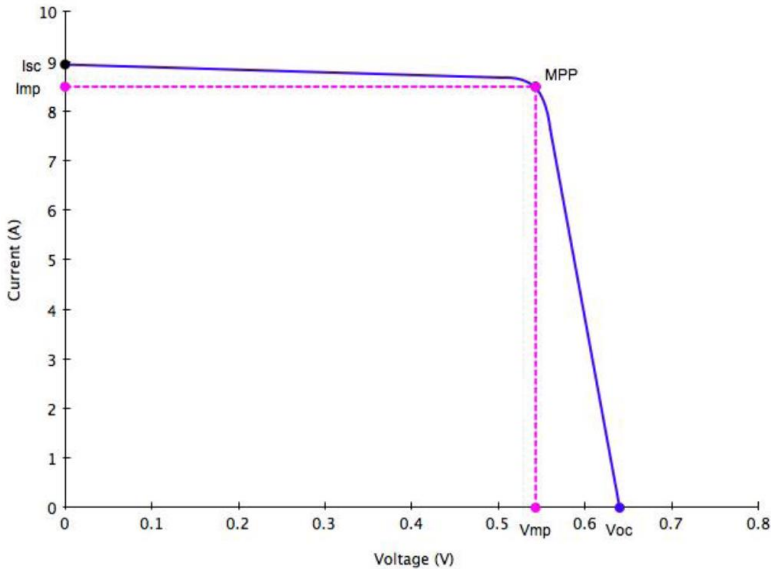

Figure 3.11 – PV Simulation Curve

Solar arrays consist of multiple solar cells characterized by a complex voltage and current profile that is represented in an I-V curve. The I-V curve of a solar array can be generated automatically or manually using one of the following two methods:



- a) Automatically generate the I-V curve by specifying four input parameters: Isc (short circuit current), Voc (open circuit voltage), Imp (maximum power current), and Vmp (maximum power voltage). Alternatively, a combination of fill factor parameters (FF, FF_i, FF_v) plus Isc and Voc can be used to characterize the solar array. Up to 16 sets of curve parameters can be created and downloaded to the PVS supply's non-volatile memory or entered directly from the front panel. Based on these input parameters, the power supply will then automatically calculate

the I-V profile.



- b) Manually generate the I-V curve by creating a user-defined table of points in the SAS software. Up to 1024 I-V points can be downloaded to the PVS supply's non-volatile memory.



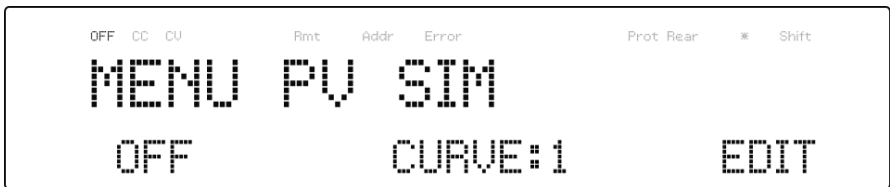

Once one of these I-V curves has been selected and set from the front panel, the power supply will operate in PV mode and output a voltage and current value according to the active I-V profile and load conditions. Different points on the I-V curve will be output in 1 ms intervals to test the inverter's MPPT efficiency. To create a user-defined table of I-V points and simulate a change in irradiance conditions (e.g. cloudy or rainy day), the PV supply must be controlled by the SAS software. The SAS software also monitors and logs real-time voltage, current, and power as well as real-time and average MPPT efficiency to validate the inverter's MPPT algorithm.

To configure and set the PVS power supply to PV mode from the front panel, follow the steps below:





1. Press the  button and press the  button three times until **PV SIM** is blinking, then press . The following display will be shown:

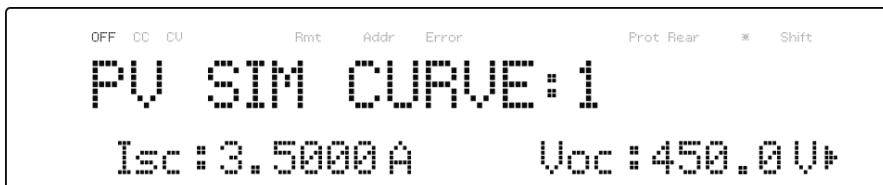

2. Use the   keys to move the cursor to the **ON/OFF** field and use the rotary knob to select **ON** or **OFF**. ON means the PVS supply is set to PV mode.

- Use the   keys to move the cursor to the **CURVE** field and use the rotary knob to select the desired curve number. The curve number can be **1-16** or **TABLE** (table of up to 1024 I-V points.)
- Once again, use the   keys to move the cursor to the **EDIT** field and press . The following display will be shown:



- Use the   keys to move the cursor through the four parameter settings. Use the numerical keys to enter parameter values and press  to confirm each of the four parameter settings.
Press  several times to exit the menu setting.

3.8 Program Function

Overview

The PVS has a Program feature that allows storing of programs into internal non-volatile memory and recalling and running them per configured parameters. A total of 100 steps can be configured for each program, and a total of 9 programs are available for storage. Additionally, multiple programs or all 9 programs can be saved into a program configuration, where each program configuration allows running one program after another or repeat a finite number of times. This allows for a total of 900 steps in one configuration. Below is an

illustration of how programs are structured, stored, and recalled.

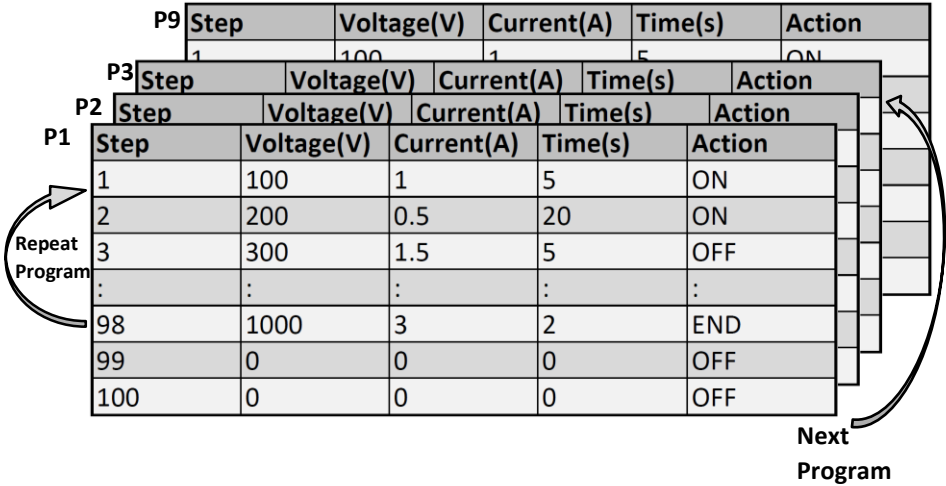

Figure 3.12 – Program Structure Illustration

Configure Program Parameters

Actions

The program function is used to edit a test pattern composed by steps. Each step contains the voltage, current, time, and action. There are three types of actions that can be set: **ON**, **OFF**, and **END**. The **ON** action enables the current step and will be executed during operation. The **OFF** action disables the current step and will not be executed during operation. The **ON** and **OFF** actions are easily interchangeable, which allows the user to easily edit the program procedure. If some steps need to be removed from the procedure, just set the corresponding steps to **OFF**, avoiding the need to re-edit all of the program steps. The **END** action renders the current step to be the end of the program.

Options

Users also have the ability to utilize the **REPEAT** and **NEXT PROG** options. The **REPEAT** option allows the user to execute the same program as many times, continuously, as needed. The **NEXT PROG** option allows the user to select the next program to execute once the current program ends. Please be aware that **REPEAT** and **NEXT PROG** options are part of a program, so if one program's **NEXT PROG** option is pointed to a previous program, the power supply will cycle these programs infinitely.

Configure

An example of a program is illustrated below:

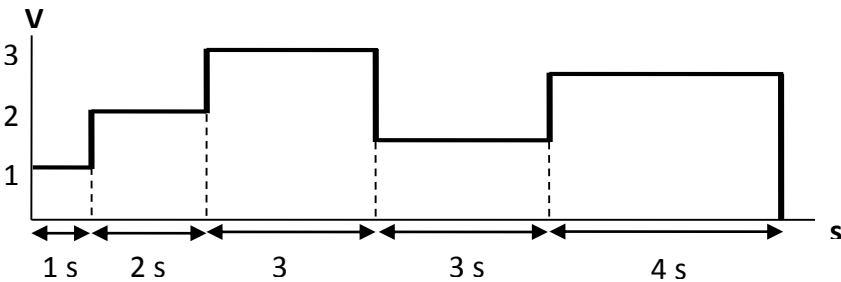







Figure 3.13 – Program Sequence Example



Follow the steps below to set up a program.

1. Press the **Prog.** button to enter the program function settings.
The following will be displayed:







2. Use the rotary knob to select the setting of **OFF** or **ON**.
3. Use the   buttons to move the cursor to the **PROGRAM** selection and use the rotary knob to select a program between 1-9.
4. Use the   buttons to move the cursor to the **EDIT** selection and press . The following screen will be displayed:



5. As described previously, each step has the following parameters to be edited: step number, action, voltage, current, and time. Use the   buttons to move the cursor to the desired parameter and use the rotary knob or keypad (numeric values only) to change the parameter values. Change the step value and continue this procedure for each step for as many steps as needed.
6. Once an **END** action step is entered, pressing  will finalize the program steps and the following will be displayed:



- At this point, the user may select how many times they wish the current program to repeat in the **REPEAT** field, by using the keypad or the rotary knob.
- Press  to select **NEXT PROG** parameter and use the rotary knob to select a value of **NONE** or a value of **1-9**. As described previously, the user has the ability to queue another program once the current program is finished. By default, **NONE** is placed as the parameter value.
- Press  to complete the program configuration.
- Make sure the program is turned ON and press  to exit the program settings.
- Once the output state is enabled, by pressing , the program will automatically execute. The following will be displayed when the program is executing:

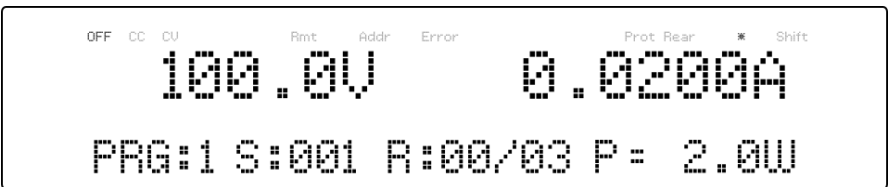

When program mode is running, an * indicator on the display will flash to indicate the program is running. The current program (PRG: p), step (S: sss) and repeat number (R: xx / yy) will also show on the display. Where p is the program number, sss is the step number, xx is the present repeated number and yy is the total repeat number. For

example, if the xx is 01 and yy is 03, this means that there are three repeats of this program and it is now running the first repeat.

3.9 Timer Function

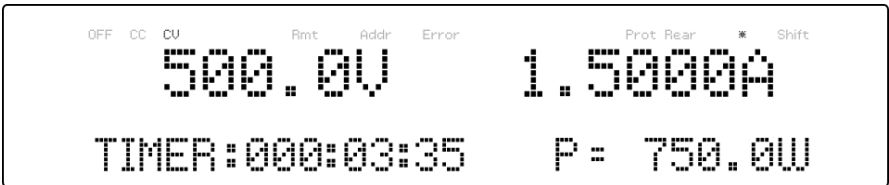

The timer function is a countdown clock, which allows the user to setup how long the output will be enabled when it is initially turned ON. When it is running, a clock on the display counts down until it reaches zero and the output will turn OFF. An * indicator on the display will flash to indicate the timer is running. When the timer is running, the following screen will be displayed:







To activate the timer function, follow the steps below:

1. Press the **Shift** and **Iset** buttons to enter the timer setup screen. The following will be displayed:







2. Use the   buttons to move the cursor to the desired parameter (hour, minute, and second) and use the keypad to change the parameter values.

- Use the   buttons to move the cursor to the **ON/OFF** parameter and use the rotary knob to change **ON** or **OFF**.
- Press  to complete the timer setting.
- Pressing the  key will enable the output and start the timer.



3.10 Slew Rate Setting

The power supply has the capability of controlling the output voltage and current slew rate. The timing can be configured for the rising/falling edge between voltage and current output transitions.

Follow the steps below to configure the voltage or current slope .

- Press  and  buttons to enter the slope menu.
- Use the   buttons to select **VOLTAGE** or **CURRENT** and press  to confirm. The following will be displayed:



- Use the keypad or rotary knob to enter the slope value and press  to confirm.
- Press  to exit the slope menu.

4 Remote Operation

There are several interfaces available for remote communication: USB, RS-232, GPIB, Ethernet, and RS-485. With all these interfaces, this power supply is very flexible to be controlled remotely. Users can program the power supply by using the SCPI (Standard Commands for Programmable Instruments) commands over any one of the remote interfaces. This section will describe how to set up all of the supported interfaces.

Note: The **RMT** indicator will appear on display when the power supply is successfully connected to a PC remotely through any remote interface. Keys on the front panel will be locked until the instrument is in LOCAL mode. To return to LOCAL mode from the front panel, press

Local



The **RMT** indicator will disappear when the instrument is in LOCAL mode.



4.1 Interface Configuration

USB (Virtual COM)





The standard USB port is a virtual COM port that can be used for remote communication. There are no settings in the menu system for USB configuration. To configure the USB settings, refer to the RS-232 settings below, as they are the same.

RS-232

Follow the steps below to configure the power supply for RS-232 operation:

1. From the **SYSTEM** menu, select **Communication** and press .
2. Press  button three times until **RS-232** is blinking and press  to configure the settings for RS-232 remote communication. The following display will be shown:



3. Use   keys to select between each serial settings and press  to configure the corresponding settings.
4. To change the baud rate or any of the parameter settings, use the rotary dial.
5. Press  to save each setting and the display will return to the **RS232** menu.
6. Below lists the options that can be changed for each setting:
Baud rate: 9600, 19200, 38400, 57600
Parity/Data bits: None/8 bits, Even/8 bits, Odd/8 bits, Even/7 bits, Odd/7 bits
Stop bit: 1, 2
Flow control: None*

Note: The default is 9600, None/8 bits, 1.

*** The RS-232 interface does not have flow control mechanism. The programmer should be aware of this limitation and notice the command process time of the power supply. If the remote commands are sent too fast to the power supply, the internal buffer may overrun and cause a communication error.**

Therefore, a delay between commands to let the power supply have enough time to process them is mandatory.

7. All serial settings must match the settings configured on the PC in order for communication to link successfully.

GPIB

Each model can be configured with a GPIB address from 1-30. Follow the instructions below to select and configure the GPIB interface for remote operation.

1. From the **SYSTEM** menu, select **Communication** and press .
2. When **GPIB** is blinking, press to configure the settings for GPIB remote communication. The following display will be shown:



3. Press to configure the GPIB **Address** to which the power supply will be assigned to. Use the rotary dial or numeric keypad to enter a value from 1-30.
4. Press to save each setting and the display will return to the **GPIB** menu.
5. Make sure the address assigned in the power supply unit matches the address the data commands are being sent to.

RS-485

The PVS series supports multiple power supplies (up to 30) that can be connected together via RS-485 and be controlled with a computer via USB (virtual COM) interface. If connecting more than 10 units, add a 120Ω resistor terminator to the last unit as shown in the figure below.

Follow the instructions below to select and configure the RS-485 interface for remote operation.

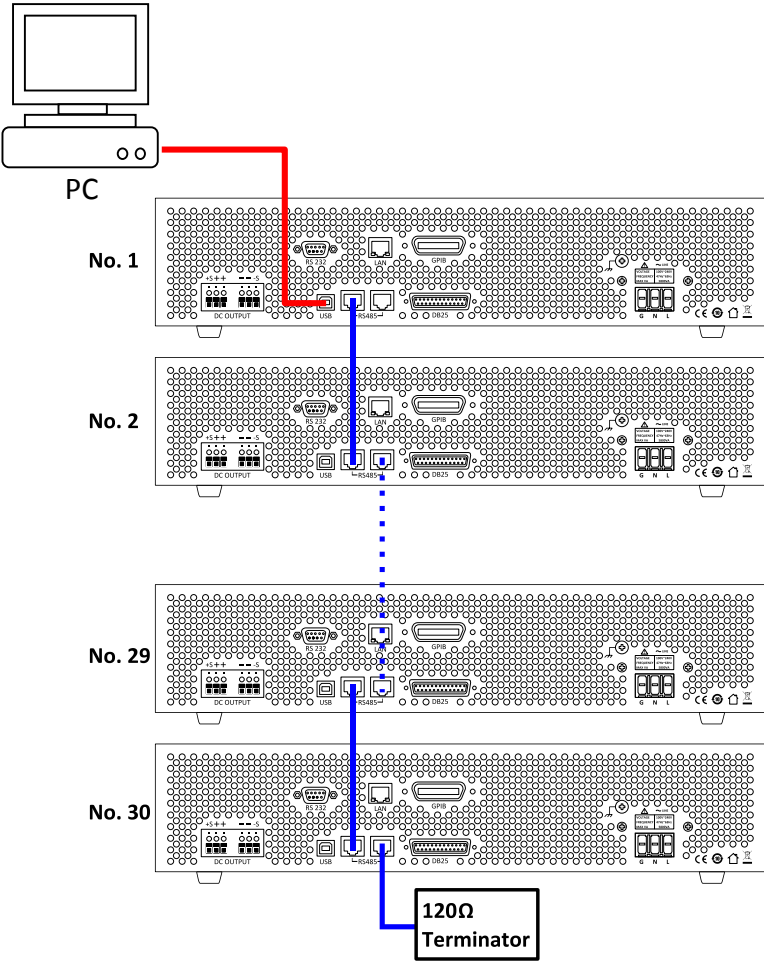









Figure 4.1 – RS-485 Connection Diagram for 10+ Units

1. From the **SYSTEM** menu, browse and select **Communication** and press .
2. Press  button two times until **RS-485** is blinking and press  to configure the settings for RS-485 remote communication. The following display will be shown:



3. Use   keys to select between each settings and press  to configure the corresponding setting.
4. To change the parameter settings, use the rotary dial.
5. Press  to save each setting and the display will return to the **RS485** menu.
6. Below lists the options that can be changed for each setting:
Baud rate: 9600, 19200, 38400, 57600
Parity/Data bits: None/8 bits, Even/8 bits, Odd/8 bits, Even/7 bits, Odd/7 bits
Stop bit: 1, 2
Address: 1 to 30
Chain: On, Off

Note: The default is 9600, None/8 bits, 1, Address = 1, Off.

7. For each power supply that you want to control, provide a different address. For example, if you have three power supplies to control, set the first supply to address 1, second supply to address 2, and third supply to address 3. If two or



more supplies have the same address, the RS485 protocols will create communication errors.

- Repeat the above steps for each power supply that you want to connect together and control, making sure that each of them have a different address assigned.
- Connect the USB of the first supply (address 1) to the computer, then use the Multi-Unit Programming commands to communicate with each power supply. Refer to “4.7 Multi-Unit Programming Commands”.



LAN (Ethernet)

The LAN interface supports Telnet connection and Socket connection. It also can be used to connect with the built-in web server GUI.

Follow the instructions below to select Ethernet interface for remote operation.

- From the **SYSTEM** menu, select **Communication** and press .
- Press  button once until **LAN** is blinking and press  to configure the settings for LAN remote communication. The following display will be shown:



- Use   keys to select between each settings and press  to configure the corresponding setting.
- To change any of the parameter settings, use the rotary dial.

5. Press  to save each setting and the display will return to the **LAN** menu.
6. The following lists the options that can be changed for each setting:
Mode: Web, Tel, Socket
IP Addr: 000.000.000.000
Gway: 000.000.000.000
Mask: 000.000.000.000

Web server

There is an embedded web server GUI that can access the power supply via LAN interface using a web browser. The GUI provides a simple way of setting voltage and current, as well as monitoring the output, using a web browser from a computer connected to the same local area network as the power supply. To access this, do the following:

1. Connect the power supply to the same network as the PC.
2. Open a web browser on the computer to control the power supply.
3. Check the IP address of the power supply through INFO in the MENU.
4. Type the IP address of the power supply in the URL bar of your browser with http:// prefix (i.e. http://192.168.1.55 for IP Address 192.168.1.55).
5. If correctly configured, the following screen will be shown:



DC Source Web Login Page

Please enter password to continue

PASSWORD

Figure 4.2 – Web Server Login Page

6. A password is required to login and access the menu items on the page. The default admin password **123456**. The web server menu items are described below:

HOME

The HOME page provides general information of the power supply: Model, Manufacturer, Firmware version, MAC address, IP address, RS-232C setting, and RS-485 setting.

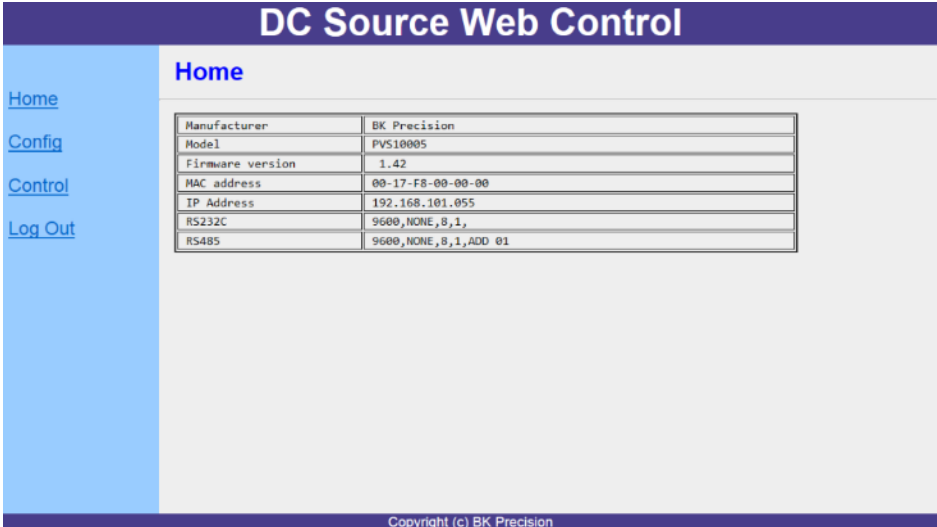

Figure 4.3 – Web Server Home Page

CONFIG

The CONFIG page provides the protection settings (OVP, OCP, OPP, CV to CC, and CC to CV) and output related parameters such as voltage/current slope and limit settings.

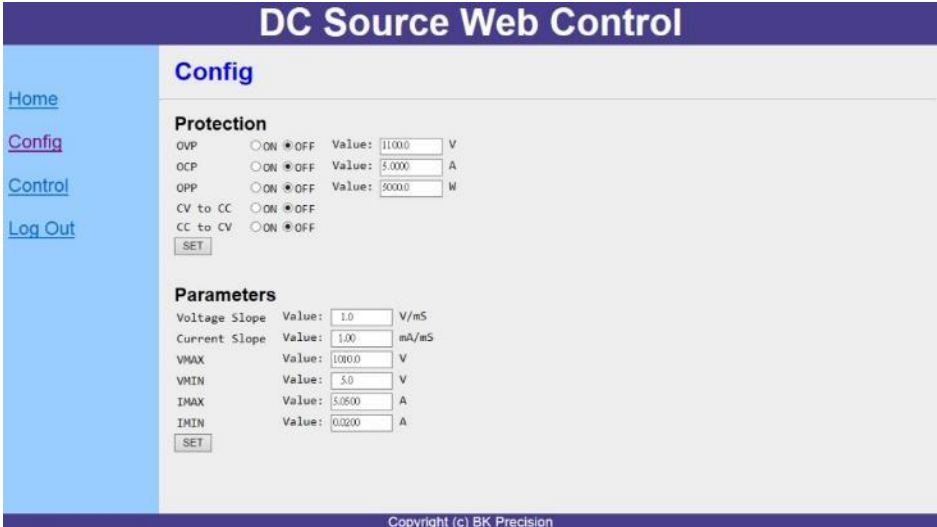

Figure 4.4 – Web Server Configuration Page

CONTROL

The CONTROL page provides the general control of the power supply such as output On/Off setting as well as the voltage and current setting. The command line for SCPI commands can also be accessed here.

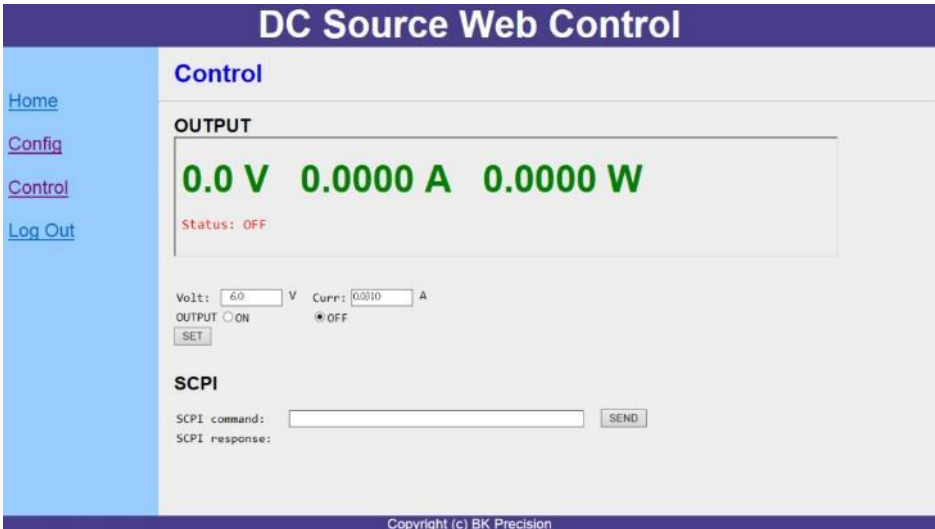

Figure 4.5 – Web Server Control Page

The Log Out will exit the web page and go back to login screen.

Telnet connection

The power supply can be connected via LAN (Ethernet) interface using Telnet client with socket port **23 or 5024**.

Socket connection

Socket connection is available for communication via LAN (Ethernet) interface. The instrument uses the TCP/IP protocol for communication. Users can use socket port **5025** to open a raw socket connection for sending remote commands.

4.2 Parameter Definition

The PVS power supply supports communication protocols, which include standard SCPI commands and a few proprietary commands that follow the SCPI convention. The SCPI interface enables users to operate the power supply through a computer or a terminal equipped with IEEE-488.2 GPIB, RS-232, or USB interface. SCPI IEEE-488.2 also supports multi-unit control allowing a user to control up to 30 power supplies.

The following table lists all of the numerical parameters.

Symbol	Response Formats
<bool>	Boolean value, can be 1 or "ON", 0 or "OFF"
<NR1>	Integer value, can be zero, positive or negative integer number
<NRf>	Flexible numerical value, can be zero, positive or negative float point numeric value
<string>	String value, characters enclosed in single or double
<NL>	New line, hex code 0x0Ah
<Rtn>	Return, hex code 0x0Dh

All commands should be ended with the <Rtn> and <NL> and there should be a space between command and numerical parameter.

4.3 Error/Event List

SCPI interface can offer an error/event list that contains up to 10 errors/events. Users can read the errors/events through the "SYStem:ERRor?" query command in a first-in first-out manner. Once an error/event is read, the read process will clear it from the memory. To

clear all errors/events from the memory, the “*CLS” command can be used.

The following table lists all the known errors that can be encountered.

Error	Description
-000	No error
-102	Syntax error
-103	Invalid separator
-108	Parameter not allowed
-109	Missing Parameter
-113	Undefined header
-131	Invalid suffix
-138	Suffix not allowed
-200	Execution error

4.4 SCPI Common Commands

The power supply is compatible with all IEEE-488.2 and SCPI commands. Common commands generally control overall power supply functions such as reset, status, and synchronization. All common commands consist of a three-letter mnemonic preceded by an asterisk (*). Commands ended with question mark (?) represent a query command.

The following table lists the common SCPI commands supported:

Command	Description
*CLS	Clear status
*IDN?	Return the instrument identification (<Manufacturer>,

*RCL <NR1>	Recall setting from memory
*RST	Reset
*SAV <NR1>	Save setting to memory

4.5 SCPI Common Subsystem

Subsystem commands are specific to functions. They can be a single command or a group of commands. The groups are comprised of commands that extend one or more levels below the root. The subsystem commands are arranged alphabetically according to the function they perform.

Command	Description
CONFig	Configuration subsystem
:LIMit	
:CURRent	
:MAX <NRf ?>	Set or return maximum current setting value
:MIN <NRf ?>	Set or return minimum current setting value
:VOLTage	
:MAX <NRf ? >	Set or return maximum voltage setting value
:MIN <NRf ?>	Set or return minimum voltage setting value
:EXtErnal	
:MODE < OFF/0, AMODE/1, BMODE/2 ?>	Set or return external control state
:CURRent	
:MODE < FRONT/0,	Set or return current external control

<p>EXTV/1, EXTR/2 ?></p> <p>:MONitor :RANGe < 5V/0, 10V/1 ?></p> <p>:PROGram :RANGe <5V 5K/0, 10V 10K/1 ?></p> <p>:SHUToff <Bool ?></p> <p>:VOLTage :MODE <FRONT/0, EXTV/1, EXTR/2 ?></p> <p>:PARAllel [:STATe] <Bool ?> :ROLE < MASTER/0, SLAVEA/1, SLAVEB/2, SLAVEC/3, ?></p> <p>:CHAIn [:STATe] <Bool ?> :ADDRESS <NR1 ?></p>	<p>mode</p> <p>Set or return external monitor range</p> <p>Set or return external program range</p> <p>Set or return shut-off logic state</p> <p>Set or return voltage external control mode</p> <p>Set or return parallel mode state</p> <p>Set or return parallel mode role state</p> <p>Set or return chain state</p> <p>Set or return chain address</p>
<p>FETCH</p> <p>:CURRent?</p> <p>:VOLTage?</p>	<p>Fetch subsystem</p> <p>Return the fetched output current</p> <p>Return the fetched output voltage</p>
<p>MEASure</p> <p>:ALL?</p> <p>:CURRent?</p>	<p>Measure subsystem</p> <p>Return measured output voltage and current</p> <p>Return the measured output current</p>

:VOLTage?	Return the measured output voltage
MEMory [:NUMber] <NR1 ?> :ISET <NRf ?> :SAVE :VSET <NRf ?>	Memory subsystem Select or return memory number, range 1-9 Set or return current value Save memory subsystem parameters Set or return voltage value
OUTput [:STATe] <bool ?> :LIMit :CURRent <NRf ?> :VOLTage <NRf ?> :PROtection :CLEar :SLOPe :CURRent <NRf ?> :VOLTage <NRf ?> :MODE?	Output subsystem Set or return the output state Set or return current limit value Set or return voltage limit value Reset latched protection Set or return current slewrate value Set or return voltage slewrate value Return output mode(CV or CC)
PROGRAM [:NUMber] <NR1 ?> :CLEar :ALL :NEXT <NR1 ?> :REPeat <NR1 ?> :RUN <Bool ?> :STATe <Bool ?> :STEP	Program subsystem Select or return program number, range 1-9 Clear program n parameters Clear all program parameters Set or return next program number (1-9, 0 is none) Set or return repeat number Start/stop or return the program running state Set or return program ON/OFF state

<p>[:NUMBER] <NR1 ?> :ACTION <OFF/0, ON/1, NAC/2, END/3 ?> :CURRENT <NRf ?> :ONTime <NRf ?> :VOLTage <NRf ?> :TOTAL?</p>	<p>Set or return step number Set or return step n action state Set or return step n current value Set or return step n time value Set or return step n voltage value Return program total n step numbers</p>
<p>PROTECTION [:STATE] ? :CCCV <Bool ?> :CLEar :CVCC <Bool ?> :OCP [:STATE] <Bool ?> :LEVel <NRf ?> :OPP [:STATE] <Bool ?> :LEVel <NRf ?> :OVP [:STATE] <Bool ?> :LEVel <NRf ?></p>	<p>Protection subsystem Return the protected state, 0=no protection happened, 1=OVP, 2=OCP, 3=OPP, 4=CV to CC and 5=CC to CV Set or return CC to CV protection switch Reset latched protection Set or return CV to CC protection switch Set or return over-current protection switch Set or return over-current protection level Set or return over-power protection switch Set or return over-power protection level Set or return over-voltage protection switch Set or return over-voltage protection</p>

PVSIMulation	level
:CURVe	PV Simulation subsystem
[:NUMber] <NR1>	Set the curve number n to write the parameters to
:PARAMeter <NRf, NRf, NRf, NRf ?>	Set or return the parameters (Isc, Voc, Imp and Vmp) of the curve number n
:SELEct <NR1 ?>	Set or return the selected curve to be running
:POWER <NRf ?>	Set or return the simulated output power from 0 ~ 100%
[:STATe] <Bool ?>	Set or return the PV simulation function state.
:TABLE	
[:NUMber] <NR1>	Set the point number n of the user defined V/I table
:PARAMeter <NRf, NRf ?>	Set or return the parameters (voltage and current) of the table point number n
:START	Start the user defined V/I table loading
:STATe?	Return the previous write status of table point, 0=not OK, 1=OK
:STOP	Stop the user defined V/I table loading
[SOURce]	Source subsystem
:CURRent	
[:LEVel] <NRf ?>	Set or return output current level
:PROTection	
[:STATe] <Bool ?>	Set or return over-current protection

<p>:LEVel <NRf ?></p> <p>:VOLTagE</p> <p>[:LEVel] <NRf ?></p> <p>:PROTection</p> <p>[:STATe] <Bool ?></p> <p>:LEVel <NRf ?></p>	<p>state</p> <p>Set or return over-current protection value</p> <p>Set or return output voltage level</p> <p>Set or return over-voltage protection state</p> <p>Set or return over-voltage protection value</p>
<p>SYStem</p> <p>:BEEP <Bool ?></p> <p>:ERRor?</p> <p>:GPIB</p> <p>:ADDRes <NR1 ?></p> <p>:GROUp <NR1 ?></p> <p>:IP</p> <p>:ADDRes<NR1.NR1. NR1.NR1 ?></p> <p>:CONFig <STATic MANUal/0, DHCP AUTO/1 ?></p> <p>:GATEWay<NR1.NR1. NR1.NR1 ?></p> <p>:MASK <NR1.NR1. NR1.NR1 ?></p> <p>:KEY</p> <p>:LOCK <Bool ?></p>	<p>System subsystem</p> <p>Set or return beep state</p> <p>Return system error</p> <p>GPIB</p> <p>Set or return GPIB address value</p> <p>Set or return memory group value</p> <p>Ethernet IP</p> <p>Set or return Ethernet IP address</p> <p>Set or return Ethernet IP mode</p> <p>Set or return ethernet IP gateway</p> <p>Set or return ethernet IP mask</p> <p>Set or return keyboard lock state</p>

<p>:PMAx?</p> <p>:POWer</p> <p> :CURRent <NRf ?></p> <p> :STATe <Bool ?></p> <p> :TYPE <OFF/0, LAST/1, USER/2 ?></p> <p> :VOLTage <NRf ?></p> <p>:RECall</p> <p> :DEFault</p> <p>:RS232</p> <p> :BAUDrate <NR1 ?></p> <p> :DATAbit <String ?></p> <p> :STOPbit <NR1 ?></p> <p>:RS485</p> <p> :BAUDrate <NR1 ?></p> <p> :DATAbit <String ?></p> <p> :STOPbit <NR1 ?></p> <p>:SERial?</p>	<p>Return the power supply's maximum output power</p> <p>Power on state</p> <p>Set or return user define current value</p> <p>Set or return user define output state</p> <p>Set or return power on mode</p> <p>Set or return user define voltage value</p> <p>Recall the factory default setting</p> <p>RS232</p> <p>Set or return RS232 baudrate value</p> <p>Set or return RS232 parity and data bit length (NONE8, EVEN8, ODD8, EVEN7, ODD7)</p> <p>Set or return RS232 stop bit length</p> <p>RS485</p> <p>Set or return RS485 baudrate value</p> <p>Set or return RS485 parity and data bit length (NONE8, EVEN8, ODD8, EVEN7, ODD7)</p> <p>Set or return RS485 stop bit length</p> <p>Return manufacturer's serial number</p>
<p>TIMER</p> <p> [:STATe] <Bool ?></p> <p> :HOUR <NR1 ?></p> <p> :MINute <NR1 ?></p> <p> :SECond <NR1 ?></p>	<p>Timer subsystem</p> <p>Enable or disable timer</p> <p>Set or return timer hour value</p> <p>Set or return timer minute value</p> <p>Set or return timer second value</p>

4.6 Non-SCPI Remote Commands

These commands are used for compatibility with old model power supplies

Command	Description
ADDR <NR1 ?>	Set or return the GPIB address
BEEP <Bool ?>	Set or return beep 0=OFF, 1=ON
CLR	Clear protection status
CURRent <NRf ?>	Set or return output current value
ERRor?	Return error message
IOUT?	return the measured output current
ISET <NRf ?>	Set or return output current value
LOCK <Bool>	Set keyboard lock state
MODEL?	Return model name
OCP <Bool>	Set over-current protection state
OISET <NRf ?>	Set or return over-current protection value
OPP <Bool>	Set over-power protection state
OPSET <NRf ?>	Set or return over-power protection value
OUT <Bool ?>	Set or return output state
OVP <Bool>	Set over-voltage protection state
OVSET <NRf ?>	Set or return over-voltage protection value
STATUS?	Return status of the machine
VERsion?	Return firmware version number
VOLTage <NRf ?>	Set or return output voltage value
VOUT?	Return the measured output voltage
VSET <NRf ?>	Set or return output voltage value

4.7 Multi-Unit Programming Commands

The multi-unit programming commands used by the power supply include a carriage return (CR) character for termination of all ASCII strings. For all configuration commands (except for commands listed under Synchronous Control Commands section), the instrument will return a string “OK” to indicate command sent successfully. If an error occurs, it will return an error. See the “Error list” section for details.

System control commands

This set of commands is used to select the instrument (based on their address) to control, obtain, and set its system settings.

Command	Description
CADR	Select the address, which can be 1 to 30, of the power supply to access and control.
CCLS	Clear status
CRST	Reset command. Brings the power supply to a known state
CIDN?	Return the power supply model identification
CREV?	Return the firmware version
CSN?	Return the serial number
CST?	Return the device status
CCLR?	Clear protect

Output control commands

This set of commands controls the outputs of the selected instrument (based on their address). As described in the previous section, use the CADR command first to select the address of the unit under control

before using any of these commands to control that unit's output.

Command	Description
CPV	Set the output voltage value in Volts
CPV?	Read the output voltage setting
CMV?	Read the actual output voltage
CPC	Set the output current value in Amperes
CPC?	Read the output current setting
CMC	Read the actual output current
CDVC?	Display voltage and current data
COUT	Turn the output to ON or OFF
COUT?	Return the output On/Off status
COV	Set the OVP level
COV?	Return the OVP setting level
COVP	Set the OVP on/off
COVP?	Return the OVP on/off
COC	Set the OCP level
COC?	Return the OCP setting level
COCP	Set the OCP on/off
COCP?	Return the OCP on/off
COP	Set the OPP level
COP?	Return the OPP setting level
COPP	Set the OPP on/off
COPP?	Return the OPP on/off
CMODE?	Return the power supply operation mode

Synchronous control commands

This set of commands can be used to control all the power supplies

connected in the RS-485 chain at once. Note that these commands will not return an “OK” string upon making a configuration.

Command	Description
GRST	Reset command. Brings the power supply to a known state
GCLS	Clear status
GCLR	Clear protect
GPV	Set the output voltage value in Volts
GPC	Set the output current value in Amperes
GOUT	Turn the output to ON or OFF
GOV	Set the OVP level
GOVP	Set the OVP on/off
GOC	Set the OCP level
GOCP	Set the OCP on/off

Error List

When using any of the commands for multi-unit programming for configuration, a response string is returned. If the command was sent successfully to the power supply(s) (except for synchronous control commands), the return string will be “OK”. Otherwise, an error message will occur. See the table below for the list of errors and their descriptions.

Return String	Description
Time out	Wait response time has timed out
Range error	Input value is out of range
Multi master	More than one master is in the chain

Status Define

The “CST?” command queries the device status. The returned status is defined in the following table:

Byte0	Bit7	OVP ON/OFF status
	Bit6	OCP ON/OFF status
	Bit5	OPP ON/OFF status
	Bit4	CC to CV protection ON/OFF status
	Bit3	CV to CC protection ON/OFF status
	Bit2	Output ON/OFF status
	Bit1	Reserved
	Bit0	Reserved
Byte1	Bit7	OVP occurred flag
	Bit6	OCP occurred flag
	Bit5	OPP occurred flag
	Bit4	CC to CV protection occurred flag
	Bit3	CV to CC protection occurred flag
	Bit2	AC input voltage too low
	Bit1	OTP occurred flag
	Bit0	Reserved
Byte2	Bit7	Reserved
	Bit6	Reserved
	Bit5	Reserved
	Bit4	Reserved
	Bit3	Reserved
	Bit2	Reserved
	Bit1	Reserved
	Bit0	Reserved

These 3 bytes will be represented by a hexadecimal numbered string.

For example, if the OVP, OCP, and OPP ON/OFF switches are ON and the output is ON, the return value will be E40000.

	Bit7	Bit6	Bit5	Bit4	Bit3	Bit2	Bit1	Bit0	String
Byte0	1	1	1	0	0	1	0	0	E4
Byte1	0	0	0	0	0	0	0	0	00
Byte2	0	0	0	0	0	0	0	0	00

5 Calibration



B&K Precision recommends a calibration interval of one year to ensure that the power supply meets specifications. This instrument features closed-case calibration. To perform the calibration, the following equipment is required:

- 5 ½ digit digital multimeter (DMM); B&K Precision 5491B or equivalent

WARNING

The following calibration instructions may be used by authorized technicians or calibration personnel only. If you are not authorized, do not attempt to calibrate the instrument yourself, as it may damage the instrument and void the warranty.

To enter the calibration procedure, follow the steps below:

1. Press the  button and press the  button until CAL is selected and blinking and press .

2. Enter the password **13579**, using the numeric keypad, and press the **Enter** key to confirm. The following display will be shown:

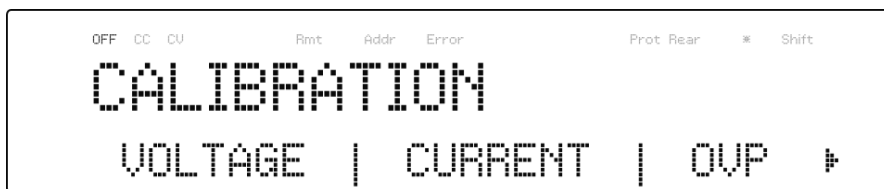

Below is a list of calibration options:

1. Output voltage
2. Output current
3. Overvoltage protection
4. Overcurrent protection
5. External voltage programming
6. External current programming
7. Constant current of external voltage programming
8. Constant current of external current programming

These options are only accessible in the calibration menu. The following calibration procedures assume the operator is in the **CAL** menu.

5.1 Voltage Calibration

Follow the steps below to perform the voltage calibration:

1. Connect the DMM to the output of the power supply as shown in the figure below:

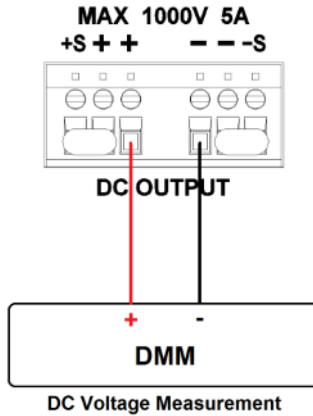

Figure 5.1 – Voltage Calibration Diagram

- Set the DMM to a DC voltage measurement. Select the **VOLTAGE** parameter in the **CAL** menu and press **Enter**. The following will be displayed:



The *P: 1/4* signifies there are 4 points to be calibrated, and the current calibration point is 1.

- Input the voltage reading from the DMM in the **METER** parameter by using the numeric keypad and press **Enter**.
- Repeat this procedure by entering the meter readings for points 2 – 4.

5.2 Current Calibration

Follow the steps below to perform the current calibration:

1. Connect the DMM to the output of the power supply as shown in the figure below:

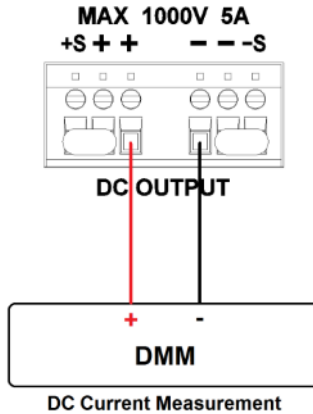

Figure 5.2 – Current Calibration Diagram

2. Set the DMM to a DC current measurement. Select the **CURRENT** parameter in the **CAL** menu and press **Enter**. The following will be displayed:



The *P: 1/4* signifies there are 4 points to be calibrated, and the current calibration point is 1.

3. Input the current reading from the DMM in the **METER** parameter by using the numeric keypad and press **Enter**.

- Repeat this procedure by entering the meter readings for points 2 – 4.

5.3 OVP Calibration

The overvoltage protection (OVP) calibration can be executed right after the voltage calibration or the user can select **OVP** in the **CAL** menu.

Follow the steps below to perform the overvoltage protection calibration:

- Disconnect any load from the output terminal of the power supply.
- Select the **OVP** parameter in the **CAL** menu and press **Enter**. The following will be displayed:



- Press **Enter** to run the OVP calibration or press **Esc** to abort. The OVP calibration is an automatic process that will take about 10 to 20 seconds.
- After the calibration is finished, the following message will be displayed:

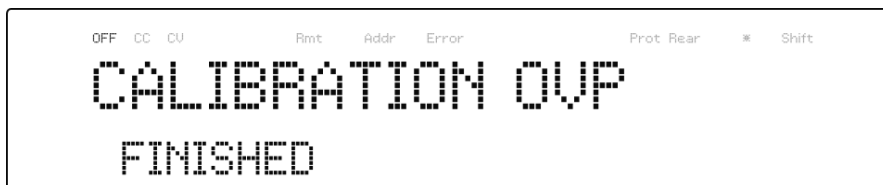

5.4 OCP Calibration

The overcurrent protection (OCP) can be executed right after the current calibration or the user can select **OCP** in the **CAL** menu.

Follow the steps below to perform the voltage calibration:

1. Short the output + and - terminals of the power supply as shown below:

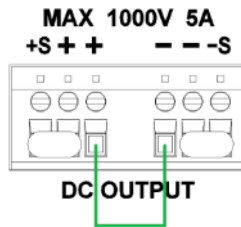
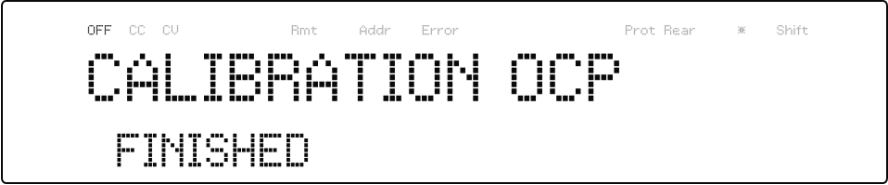

Figure 5.3 – OCP Calibration Diagram

2. Select the **OCP** parameter in the **CAL** menu and press **Enter**. The following will be displayed:



3. Press **Enter** to run the OCP calibration or press **Esc** to abort. The OCP calibration is an automatic process that will take about 20 to 30 seconds.
4. After the calibration is finished, the following message will be displayed:



5.5 External Voltage Programming Calibration

Follow the steps below to perform the external voltage programming calibration:

1. Connect the DMM to the external analog control terminals of DB25 connector (+ on the DMM to Pins 9 and 11, - on the DMM to Pin 22 (GND)) on the rear of the power supply, as shown in the figure below:

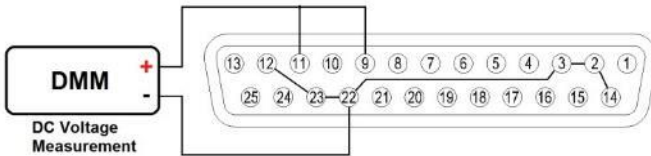
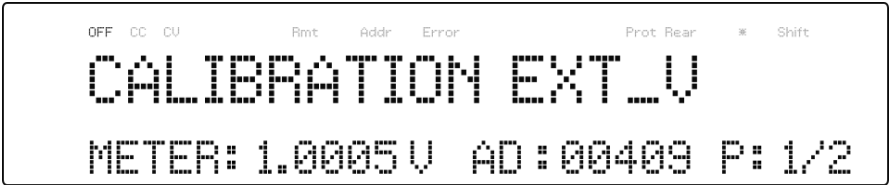

Figure 5.4 – External Voltage Programming Calibration Diagram

2. Set the DMM to a DC voltage measurement. Select the **EXT_VOLT** parameter in the **CAL** menu and press **Enter**. The following will be displayed:



The *P: 1/2* signifies there are 2 points to be calibrated and the current calibration point is 1.

3. Input the voltage reading from the DMM in the **METER** parameter by using the numeric keypad and press .
4. Repeat this procedure by entering the meter readings for points 2.

5.6 External Current Programming Calibration

Follow the steps below to perform the external current programming calibration:

1. Connect the DMM to the external analog control terminals of DB25 connector (+ on the DMM to Pins 10 and 24, - on the DMM to Pin 22(GND)) on the rear of the power supply, as shown in the figure below:

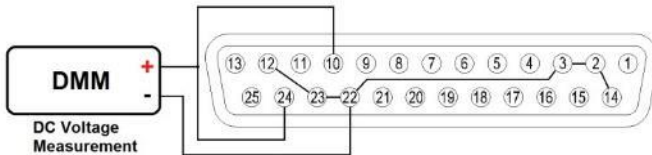
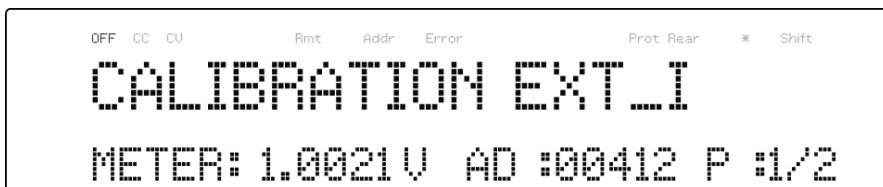

Figure 5.5 – External Current Programming Calibration Diagram

2. Set the DMM to a DC voltage measurement. Select the **EXT_CURR** parameter in the **CAL** menu and press **Enter**. The following will be displayed:



The *P: 1/2* signifies there are 2 points to be calibrated and the current calibration point is 1.

3. Input the voltage reading from the DMM in the **METER** parameter by using the numeric keypad and press **Enter**.
4. Repeat this procedure by entering the meter readings for points 2.

5.7 CC Calibration of External Voltage

Follow the steps below to perform the calibration procedure for the constant current source of the external voltage programming by resistor mode:

1. Connect the DMM to the external analog control terminals of DB25 connector (+ on the DMM to Pins 9, - on the DMM to Pin 22(GND)) on the rear of the power supply, as shown in the figure below:

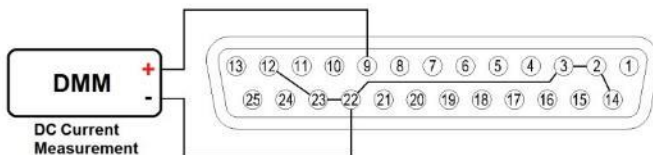

Figure 5.6 – CC Calibration of External Voltage Diagram

2. Set the DMM to a DC current measurement. Select the **EXT_V_CC** parameter in the **CAL** menu and press **Enter**. The following will be displayed:



3. Input the current reading from the DMM into the **METER** parameter by using the numeric keypad and press **Enter**.

5.8 CC Calibration of External Current

Follow the steps below to perform the calibration procedure for the constant current source of the external current programming by resistor mode:

1. Connect the DMM to the external analog control terminals of DB25 connector (+ on the DMM to Pins 10, - on the DMM to Pin 22(GND)) on the rear of the power supply, as shown in the figure below:

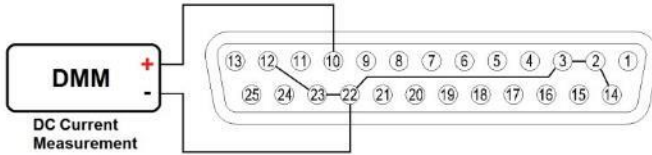

Figure 5.7 – CC Calibration of External Current Diagram

- Set the DMM to a DC current measurement. Select the **EXT_I_CC** parameter in the **CAL** menu and press **Enter**. The following will be displayed:



- Input the current reading from the DMM into the **METER** parameter by using the numeric keypad and press **Enter**.

6 Troubleshooting Guide

Below are some frequently asked questions and answers. Please check if any apply to your power supply before contacting B&K Precision.

General

Q: I cannot power up the power supply.

- Check that the power cord is securely connected to the AC input and there is live power from your electrical AC outlet.
- Verify that the AC power coming from the mains contains the correct voltage. The power supply can accept a specific range of AC input voltages. Refer to section 2.1.

Q: How do I set up the supply to run in constant current mode?

- The supply is a CV/CC power supply that automatically crosses over from CV to CC upon a load which draws current at the current limit (ISET). Therefore, it is dependent on the load. For example, if ISET is configured as 1 A, the load must draw 1 A before the supply will go into CC mode.

Q: How come my display voltage is lower than the voltage I set?

- This is often because of the resistances from the test leads/wires connected between the supply and the DUT (device under test), which causes a drop in voltage. To minimize this drop, use remote sense terminals to compensate and output a more accurate voltage to the DUT.

Q: I cannot set voltage at the maximum rating.

- This may be that the set voltage is outside of the voltage maximum limit. Refer to section 3.6 under “Output Limit Settings**Error!** Reference source not found.” to verify and configure the limits.

Remote Control

Q: I am trying to send the commands over USB/RS232, but it does not seem to respond.

- Check that you are sending ASCII strings that are terminated with a CR (carriage return) and LF (linefeed) character.
- For RS-232 and RS-485, check that the baud rate, parity, data bits, stop bit, and flow control settings match with the settings configured on the software interface.
- For RS-485, check that the wires are correctly daisy chained between multiple units.

7 Specifications

Note: All specifications apply to the unit after a temperature stabilization time of 15 minutes over an ambient temperature range of $23\text{ }^{\circ}\text{C} \pm 5\text{ }^{\circ}\text{C}$. Specifications are subject to change without notice.

Environmental Conditions:

This power supply is designed for indoor use and operated with maximum relative humidity of 90%.

Model	PVS60085	PVS60085MR	PVS10005
Output Rating			
Output Voltage ¹	0 – 600 V		0 – 1000 V
Output Current ²	0 – 8.5 A		0 – 5 A
Output Power	5100 W	3000 W	5000 W
Line Regulation			
Voltage	60 mV		100 mV
Current	4.25 mA		2.5 mA
Load Regulation			
Voltage	60 mV		100 mV
Current	8.5 mA		5 mA
Ripple and Noise (20Hz-20MHz)			
Voltage	$\leq 100\text{ mVrms/}$ $\leq 500\text{ mVpp}$		$\leq 100\text{ mVrms/}$ $\leq 600\text{ mVpp}$
Current	15 mA		10 mA
Resolution			
Programming	10 mV / 0.2 mA		0.1 V / 0.1 mA
Readback	10 mV / 0.2 mA		0.1V / 0.1 mA

Programming Accuracy			
Voltage	400 mV		700 mV
Current ³ (± (%output +offset))	0.03% + 3.5 mA		0.03% + 2 mA
Readback Accuracy ± (%output +offset)			
Voltage	0.05 % + 300 mV		0.05 % + 500 mV
Current ³	0.1 % + 8.5 mA		0.1 % + 5 mA
General			
Transient Response ⁴	≤ 0.5 ms		≤ 0.5 ms
OVP Adjustment Range	5 – 660 V		5 – 1100 V
OVP Accuracy	6 V		10 V
OCP Accuracy	85 mA		50 mA
Command Response	20 ms		20 ms
Efficiency ⁵	90 %		90 %
Power Factor	0.99		0.99
Remote Sense	6 V		10 V
Rising Time at Full Load	≤ 100 ms		≤ 250 ms
Rising Time at No Load	≤ 100 ms		≤ 250 ms
Falling Time at Full Load	≤ 100 ms	≤ 150 ms	≤ 250 ms
Falling Time at No Load	≤ 3000 ms		≤ 5000 ms
Standard Interface	Analog Programming, USB, RS485, RS232, GPIB, Ethernet		
AC Input ⁶	170 - 265 VAC, single phase		
Rated Frequency	47 - 63 Hz		
Maximum Rated Input	5800 VA	3500 VA	5800 VA
Operating Temperature	0 °C - 40 °C		
Storage Temperature	-40 °C - 85 °C		
Dimensions (W×H×D)	420 × 88 × 532 mm		
Weight	14.6 kg		

¹ Minimum voltage is guaranteed to 5V.

² Minimum current is guaranteed to maximum 0.4% of rated output current.

³ Current accuracy is applied when output power > 0.1% of full power.

⁴ Time for output voltage to recover within 0.5% of its rated output for a load change 50 – 100% of rated output current.

⁵ 90% typical at nominal line and max load.

⁶ 10% of output de-rated when operating below 190 VAC.

To ensure the most current version of this manual, please download the latest version here: <http://www.bkprecision.com/search/PVS>

For current up-to-date product information, please visit www.bkprecision.com

SERVICE INFORMATION

Warranty Service: Please go to the support and service section on our website at www.bkprecision.com to obtain a RMA #. Return the product in the original packaging with proof of purchase to the address below. Clearly state on the RMA the performance problem and return any leads, probes, connectors and accessories that you are using with the device.

Non-Warranty Service: Please go to the support and service section on our website at www.bkprecision.com to obtain a RMA #. Return the product in the original packaging to the address below. Clearly state on the RMA the performance problem and return any leads, probes, connectors and accessories that you are using with the device. Customers not on an open account must include payment in the form of a money order or credit card. For the most current repair charges please refer to the service and support section on our website.

Return all merchandise to B&K Precision Corp. with prepaid shipping. The flat-rate repair charge for Non-Warranty Service does not include return shipping. Return shipping to locations in North America is included for Warranty Service. For overnight shipments and non-North American shipping fees please contact B&K Precision Corp.

B&K Precision Corp.
22820 Savi Ranch Parkway
Yorba Linda, CA 92887
www.bkprecision.com
714-921-9095

Include with the returned instrument your complete return shipping address, contact name, phone number and description of problem.

LIMITED THREE YEAR WARRANTY

B&K Precision Corp. warrants to the original purchaser that its products and the component parts thereof, will be free from defects in workmanship and materials for a period of **three years** from date of purchase.

B&K Precision Corp. will, without charge, repair or replace, at its option, defective product or component parts. Returned product must be accompanied by proof of the purchase date in the form of a sales receipt.

To help us better serve you, please complete the warranty registration for your new instrument via our website www.bkprecision.com

Exclusions: This warranty does not apply in the event of misuse or abuse of the product or as a result of unauthorized alterations or repairs. The warranty is void if the serial number is altered, defaced or removed.

B&K Precision Corp. shall not be liable for any consequential damages, including without limitation damages resulting from loss of use. Some states do not allow limitations of incidental or consequential damages. So the above limitation or exclusion may not apply to you.

This warranty gives you specific rights and you may have other rights, which vary from state-to-state.

B&K Precision Corp.
22820 Savi Ranch Parkway
Yorba Linda, CA 92887
www.bkprecision.com
714-921-9095



22820 Savi Ranch Parkway
Yorba Linda, CA 92887
www.bkprecision.com

© 2014 B&K Precision Corp.

Printed in Taiwan
v071614