

Handheld Digital Multimeter

GDM-360, GDM-397, GDM-398, GDM-461

USER MANUAL

GW INSTRUMENT PART NO. 82DM-46100MA1



ISO-9001 CERTIFIED MANUFACTURER

This manual contains proprietary information, which is protected by copyright. All rights are reserved. No part of this manual may be photocopied, reproduced or translated to another language without prior written consent.

The information in this manual was correct at the time of printing. However, we continue to improve our products and therefore reserve the right to change the specifications, equipment, and maintenance procedures at any time without notice.

Table of Contents

O VERVIEW.....	4
Unpacking Inspection	5
Safety Information	6
Rules for Safe Operation.....	7
International Electrical Symbols	9
The Meter Structure	10
Rotary Switch.....	11
Functional Buttons.....	12
Display Symbols.....	13
M EASUREMENT OPERATION	16
A. DC/AC Voltage Measurement.....	16
B. DC/AC Current Measurement.....	19
C. Resistance Measurement	22
D. Testing for Continuity	25
E. Testing Diodes	27
F. Capacitance Measurement	30
G. Frequency Measurement	33
H. Temperature Measurement (GDM-397 only)	35
I. Transistor hFE Measurement (GDM-398 only)	37
J. EF Function (GDM-398 only)	39
Hold Mode	41
RANGE button	42

MAX MIN button (GDM-360/397/398 only)	42
Peak Hold (GDM-461 only)	42
Outputting Data (Except GDM-398)	43
The Use of Relative Value Mode	44
The BLUE button	45
Turning on the Display Backlight (GDM-360/397/398 only)	45
Sleep Mode (GDM-360/397/398 only)	45
G ENERAL SPECIFICATIONS	46
Accuracy Specifications	48
DC Voltage	48
AC Voltage	50
DC Current	53
AC Current	56
Resistance	59
Capacitance	62
Frequency	65
Diode Test	66
Continuity Test	66
Temperature Measurement (GDM-397 only)	67
Transistor hFE (GDM-398 only)	67
M AINTENANCE	68
General Service	68
Replacing the Battery	69

Replacing the Fuses	71
USB and RS232C Serial Port.....	73

OVERVIEW

This User Manual covers information on safety and cautions. Please read the relevant information carefully and observe all the Warnings and Notes.

Warning

To avoid electric shock or personal injury, read the “Safety Information” and “Rules for Safe Operation” carefully before using the Meter.

Digital Multimeter Model GDM-360 (True RMS), GDM-397, GDM-398 and GDM-461 (True RMS) (hereafter referred to as “the Meter”) are auto ranging multimeters.

The Meter can measure AC/DC Voltage and Current, Resistance, Diode, Continuity Buzzer, Capacitance, Frequency and Temperature (°C or °F), hFE and EF function. In addition to the conventional measuring functions, there is an RS232C or USB serial port (optional), data hold, relative mode, peak measurement (GDM-461), low battery display, display backlight (GDM-360/397/398) and sleep mode (GDM-398/397/360). Except where noted, the descriptions and instructions in this User Manual apply to all models.

Unpacking Inspection

Open the package case and take out the Meter. Check the following items carefully to see if there are any missing or damaged parts:

Item	Description	Qty
1	User Manual	1 piece
2	Test Lead	1 pair
3	K-type Temperature Probe (thermocouple) (GDM-397 only)	1 piece
4	Multi-Purpose Socket	1 piece
5	9V Battery (NEDA1604, 6F22 or 006P) (built-in)	1 piece
6	RS232C Interface Cable (Except GDM-398)	1 piece
7	USB Interface Cable (Optional at extra cost) (Except GDM-398)	1 piece
8	Installation Guide & Computer Interface Software (CD-ROM) (Comes with the RS232C or USB Interface Cable, except GDM-398)	1 piece

In the event you find anything missing or damaged, please contact your dealer immediately.

Safety Information

This Meter complies with the EN61010-1 and EN61010-2-030 standards: in pollution degree 2, overvoltage category (CAT. III 1000V, CAT. IV 600V) and double insulation.

CAT III: Distribution level, fixed installation, with smaller transient overvoltages than CAT. IV.

CAT IV: Primary supply level, overhead lines, cable systems etc.

Use the Meter only as specified in this User Manual, otherwise the protection provided by the Meter may be impaired.

In this manual, a **Warning** identifies conditions and actions that pose as hazards to the user, or may damage the Meter or the equipment under test.

A **Note** identifies the information that a user should pay attention to.

International electrical symbols used on the Meter and in this User Manual are explained on page 9.

Rules for Safe Operation

Warning







To avoid possible electric shock or personal injury, and to avoid possible damage to the Meter or to the equipment under test, adhere to the following rules:

- Before using the Meter inspect the case. Do not use the Meter if it is damaged or if the case (or part of the case) is removed. Look for cracks or missing plastic. Pay attention to the insulation around the connectors.
- Inspect the test leads for damaged insulation or exposed metal. Check the test leads for continuity. Replace damaged test leads with those of the same type before using the Meter again.
- Do not apply more than the rated voltage, as marked on the Meter, between the terminals or between any terminal and ground.
- To prevent damage of the Meter, the rotary switch should be placed in the right position and the measurement range should not be changed during measurement.
- When measuring voltages over 60V in DC or 30V rms in AC, special care should be taken to avoid electric shock.

- Use the proper terminals, function, and range for your measurements.
- Do not use or store the Meter in an environment with high temperature, humidity, explosives, inflammable materials or strong magnetic fields. The performance of the Meter may deteriorate when dampened.
- When using the test leads, keep your fingers behind the finger guards.
- Disconnect circuit power and discharge all high-voltage capacitors before testing resistance, continuity and diodes.
- Before measuring current, check the Meter's fuses and turn off the current that is to be tested before connecting the Meter to the circuit. After connecting the circuit reliably, turn the current that is to be tested on.
- Replace the battery as soon as the battery indicator  appears. With a low battery, the Meter might produce false readings that can lead to electric shock and personal injury.
- When servicing the Meter, use only the same model number or identical electrical specifications for replacement parts.
- The internal circuit of the Meter shall not be altered to avoid damaging the Meter and to prevent accidents.

- A soft cloth and mild detergent should be used to clean the surface of the Meter when servicing. No abrasives and solvents should be used to prevent the surface of the Meter from corrosion or damage.
- The Meter is suitable for indoor use.
- Turn the Meter off when it is not in use and take out the battery when not using it for a long time.
- Constantly check the battery as it may leak when it has not been used for some time, replace the battery as soon as leaking is detected. A leaking battery will damage the Meter.

International Electrical Symbols

	AC or DC		Ground
	Double Insulated		Battery has insufficient charge
	Warning. Refer to the User Manual		Conforms to Standards of European Union

The Meter Structure (see figure 1)

1. LCD display
2. Functional buttons
3. Yellow button
4. Blue button
5. Rotary switch
6. Input terminals:

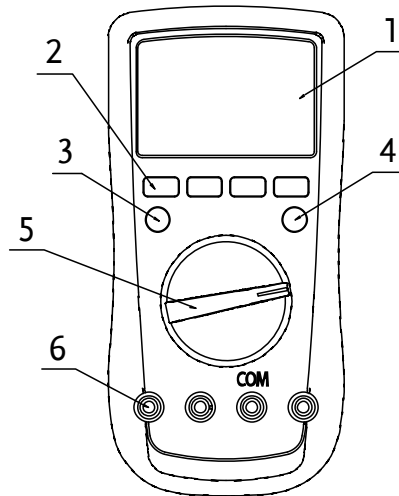







figure 1



Rotary Switch



The table below describes the relevant functions of each of the rotary switch positions.

Rotary Switch Position	Function
V_{\sim} , mV_{\sim}	AC and DC Voltage Measurement
V_{\sim}	AC Voltage Measurement (GDM-360 only)
$V_{\text{---}}$	DC Voltage Measurement (GDM-360 only)
Ω	Resistance Measurement
	Diode Test
	Continuity Test
	Capacitance Test
Hz %	Frequency and Duty Cycle Test
$^{\circ}\text{C}$	Temperature in Celsius (GDM-397 only)
$^{\circ}\text{F}$	Temperature in Fahrenheit (GDM-397 only)
hFE	Transistor (GDM-398 only)
μA 	DCA and ACA Measurement
mA 	DCmA and ACmA Measurement
10A 	10A DC and AC Measurement
EF	Sensor Test (GDM-398 only)
OFF	Power off





Functional Buttons

The table below describes what operations are performed for each of the buttons.

Button	Operation Performed
LIGHT (except GDM-461)	Press and hold for 2 seconds to turn the display backlight on or off.
Hold	Press to enter or exit data hold mode.
BLUE Button	Press to select the alternate function.
Yellow (GDM-461) Hz% (except GDM-461)	Press the Hz% button (except GDM-461) or the Yellow button (GDM-461) for frequency and duty cycle measurement.
RANGE	<ul style="list-style-type: none"> • Press RANGE to enter the manual ranging mode; the Meter beeps. • Press RANGE to step through the ranges available for the selected function; the Meter beeps. • Press and hold RANGE for 2 seconds to return to auto range mode; the Meter beeps
MAX/MIN (except 461)	Press to select the maximum and minimum value.
REL 	<ul style="list-style-type: none"> • Press to enter REL mode. • Press again to exit REL mode • For Model GDM-360/397: Press and hold for over 2 seconds to enter or exit RS232C or USB mode* (optional). <p>*Note: For the GDM-461, there is no need to hold the REL  key for 2 seconds as the RS232C/USB mode is enabled by default after powering on.</p>

	*Note: For the GDM-398, holding the REL  key 2 seconds will also display the DATA OUTPUT  symbol, however the GDM-398 has no data output capability and thus this symbol can be ignored.
PEAK (GDM-461)	<ul style="list-style-type: none"> • Press to step the display through Pmax and Pmin readings. • Press and hold for 2 seconds to exit Peak mode. • “CAL” means the meter has entered self-calibration mode.

Display Symbols

No	Symbol	Meaning
1		Data hold is active.
2		Sleep Mode indicator.
3		Indicates negative reading.
4	AC	Indicator for AC measurement.
5	DC	Indicator for DC measurement.
6	AUTO	The Meter is in the auto range mode in which the Meter automatically selects the range with the best resolution.
7	MANU	Indicator for manual ranging mode.
8	OL	The input value is too large for the selected range.
9	hFE	Transistor testing indicator.
10		Diode Test.

11		The continuity buzzer is on.
12	MAX/MIN	Maximum and Minimum reading.
13		Data output is in progress. Note: This symbol has no function on the GDM-398 and should be ignored.
14		The battery is low. ⚠ Warning: To avoid false readings, which could lead to possible electric shock or personal injury, replace the battery as soon as the battery indicator appears.
15		Sensor test is in progress.
16		The REL function is on. The Meter displays the stored value minus the measured value.
17	Ω, kΩ, MΩ	Ω: Ohm. The unit of resistance.
		kΩ: Kilohm. 1×10^3 or 1000 ohms.
		MΩ: Megaohm. 1×10^6 or 1,000,000 ohms.
	V, mV	V: Volts. The unit of voltage.
		mV: Millivolt. 1×10^{-3} or 0.001 volts.
	A, mA, μA	A: Amperes (amps). The unit of current.
		mA: Milliamp. 1×10^{-3} or 0.001 amperes
		μA: Microamp. 1×10^{-6} or 0.000001 amperes
nF, μF, mF, F	F: Farad. The unit of capacitance.	

		mF: Milli-farad. 1×10^{-3} or 0.001 farads
		μ F: Microfarad. 1×10^{-6} or 0.000001 farads.
		nF: Nanofarad. 1×10^{-9} or 0.000000001 farads
	$^{\circ}\text{C}, ^{\circ}\text{F}$	$^{\circ}\text{C}$: Centigrade. The unit of temperature.
		$^{\circ}\text{F}$: Fahrenheit. The unit of temperature.
	Hz, kHz, MHz	Hz: Hertz. The unit of frequency in cycles/second.
		kHz: Kilohertz. 1×10^3 or 1,000 hertz.
		MHz: Megahertz. 1×10^6 or 1,000,000 hertz.
	β	The unit of transistor

M EASUREMENT OPERATION

A. DC/AC Voltage Measurement (see figure 2)

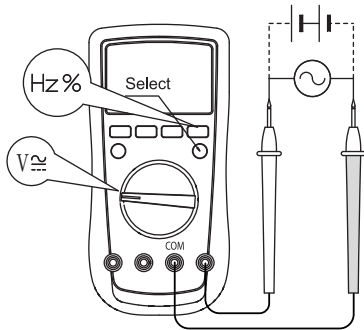

GDM-360/397/398

figure 2

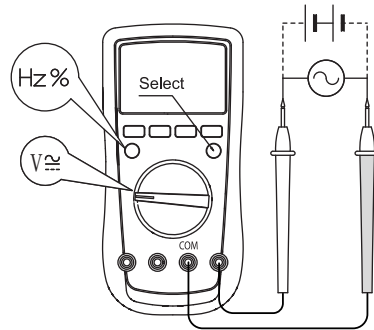

GDM-461

⚠ Note

The GDM-360 doesn't have an AC/DC voltage range (V_{\approx}). It does, however, have an AC/DC mV range (mV_{\approx}) and separate AC and DC voltage ranges (V_{\sim} , $V_{\text{---}}$).

 **Warning**

To avoid injury to your person or damage to the Meter from electric shock, please do not attempt to measure voltages higher than 1000V, although readings may be obtained.

When measuring high voltage, take extra care to avoid electric shock.

1. Insert the red test lead into the **V** terminal and the black test lead into the **COM** terminal.
2. Set the rotary switch to **V**; DC measurement is the default or press the **BLUE** button to switch between DC and AC measurement mode. Connect the test leads across to the DUT. The measured value is shown on the display.
GDM-397/398: Displays the effective value of a sine wave (mean value response).
GDM-360/461: Displays the true rms value.
3. Press **Hz%** (GDM-360/397/398) or the **yellow button** (GDM-461) to obtain the frequency and duty cycle value.
 - Input Amplitude: (DC offset is zero)
 - Input Amplitude: $\geq \text{range} \times 30\%$
 - Frequency response: GDM-397/398: $\leq 400\text{Hz}$, GDM-360/461: $\leq 1\text{kHz}$

Note

- In each range, the Meter has an input impedance of $10\text{M}\Omega$ except for the mV range which has an input impedance of $3000\text{M}\Omega$. This loading effect can cause measurement errors in high impedance circuits. If the circuit impedance is less than or equal to $10\text{k}\Omega$, the error is negligible (0.1% or less).
- For GDM-398: When measuring mV, you must press RANGE manually to enter mV range.
- For the GDM-397: The AC/DC voltage measurement ranges and the AC/DC mV measurement ranges are separated. When the rotary switch is in the AC/DC voltage position ($\text{V}\cong$), the RANGE button can be used to switch between the different voltage measurement ranges. Similarly, when the rotary switch in the AC/DC mV position ($\text{mV}\cong$), the RANGE button can be used to switch between the different mV measurement ranges.
- When voltage measurement has been completed, disconnect the testing leads from the DUT and remove the testing leads from the input terminals of the Meter.

B. DC/AC Current Measurement (see figure 3)

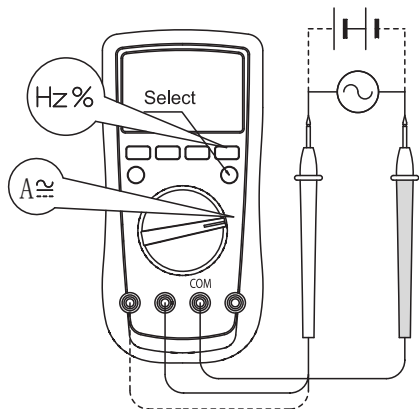

GDM-360/397/398

figure 3

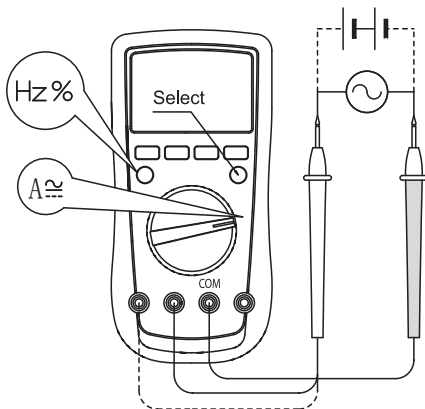

GDM-461

⚠ Warning

Before connecting the Meter to the return circuit to be tested, cut off the current of the return circuit.

If the fuse burns out during measurement, the Meter may be damaged or the operator may be hurt.

Use the proper terminals, function, and range for each measurement.

When the testing leads are connected to the current terminals, do not connect them in parallel to any circuit.

To measure current, do the following:

1. Insert the red test lead into the **μmA** or **A** input terminal and the black test lead into the **COM** terminal.
2. Set the rotary switch to **μA** , **mA**, or **A**.
3. The Meter defaults to DC current measurement mode. To toggle between the DC and AC current measurement function, press the **BLUE** button.
4. Connect the test lead in series to the return line of the circuit to be tested. The measured value is shown on the display.

GDM-397/398: Displays the effective value of sine wave (mean value response).

GDM-360/461: Displays the true rms value.

5. Press **Hz%** (**GDM-360/397/398**) or the **yellow button** (**GDM-461**) to obtain the frequency and duty cycle value.
 - Input Amplitude: (DC offset is zero)
 - Input Amplitude: $\geq \text{range} \times 30\%$
 - Frequency response: GDM-397/398: $\leq 400\text{Hz}$, GDM-360/461: $\leq 1\text{kHz}$

Note

- If the value of the current to be measured is unknown, set to the highest range and reduce the range step by step until a satisfactory reading is obtained.
- For safety, the measurement time for currents greater than 5A ($>5\text{A}$) should be less than 10 seconds and the interval time between 2 measurements should be greater than 15 minutes.
- When current measurement has been completed, disconnect the connection between the testing leads and the circuit under test, and remove the testing leads from the input terminals of the Meter.

C. Resistance Measurement (see figure 4)

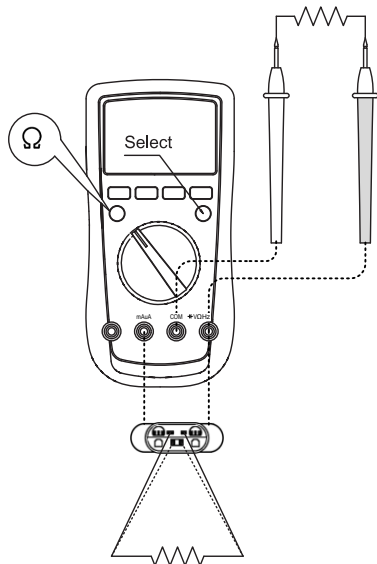

figure 4

⚠ Warning

To avoid damaging the Meter or the DUT, disconnect power from the circuit and discharge all high-voltage capacitors before measuring resistance.

To avoid harm to yourself, do not input voltages greater than DC 60V or AC 30V.

To measure resistance, connect the Meter as follows:

1. Insert the red test lead into the Ω terminal and the black test lead into the **COM** terminal.
2. Set the rotary switch to Ω ; resistance measurement (Ω) is the default or press the **BLUE** button to select Ω measurement mode.
3. Connect the test leads to the DUT. If there is a lead on the resistor or SMT resistor, it is more convenient to use the included multi-purpose socket to carry out testing.
4. The measured value shows on the display.

Note

- The test leads can add 0.2Ω to 0.5Ω of error to the resistance measurement. To obtain precise readings for low-resistance measurements, short the leads beforehand to obtain the resistance of the test leads and use the relative measurement function button, **REL Δ** , to automatically subtract the resistance of the test leads from the measured value.
- If the Ω reading with shorted test leads is not $\leq 0.5\Omega$, check to see that the test leads are properly connected and are not loose.
- For high-resistance measurements ($>1M\Omega$), it is normal to take several seconds to obtain a stable reading. To obtain a stable reading, use test leads that are as short as possible or use the included multi-purpose socket to carry out the measurement.
- The LCD displays **OL** to indicate an open-circuit or that the resistor value is higher than the selected range of the Meter.
- When resistance measurement has been completed, disconnect the connection between the testing leads and the circuit under test, and remove the testing leads away from the input terminals of the Meter.

D. Testing for Continuity (see figure 5)

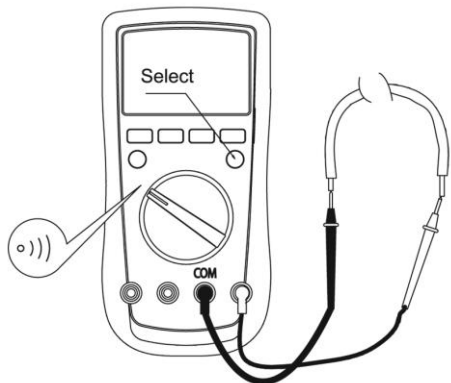

figure 5

⚠ Warning

To avoid damage to the Meter or to the device under test, disconnect the circuit power and discharge all high-voltage capacitors before testing for continuity.

To avoid harm to yourself, do not input voltages greater than DC 60V or AC 30V.

To test for continuity, connect the Meter as described below:

1. Insert the red test lead into the Ω terminal and the black test lead into the **COM** terminal.
2. Set the rotary switch to $\bullet\Omega$ and press **BLUE** button to select $\bullet\Omega$ measurement mode.
3. The buzzer sounds continuously if the resistor to be tested is $<10\Omega$.
The buzzer does not sound if the resistor to be tested is $>35\Omega$.

Note

- GDM-360/397/398: open circuit voltage is around 0.45V
GDM-461: open circuit voltage is around -3V
- When continuity testing has been completed, disconnect the connection between the testing leads and the circuit under test, and remove the testing leads away from the input terminals of the Meter.

E. Testing Diodes

(see figure 6)

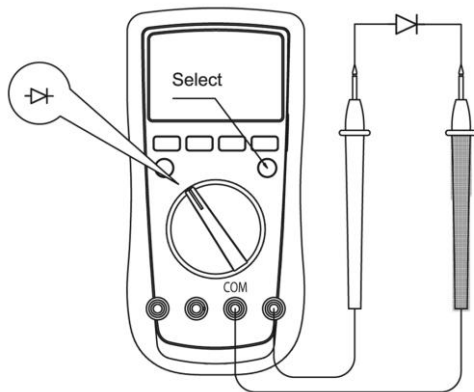



figure 6

⚠ Warning

To avoid possible damage to the Meter and to the device under test, disconnect the circuit power and discharge all high-voltage capacitors before testing diodes.

To avoid harm to yourself, do not input voltages greater than DC 60V or AC 30V.

1. Insert the red test lead into the Ω terminal and the black test lead into the **COM** terminal.
2. Set the rotary switch to  and press **BLUE** button to select the  measurement mode.
3. For forward voltage drop readings on any semiconductor component, place the red test lead on the component's anode and place the black test lead on the component's cathode. The measured value shows on the display.

Note

- In a circuit, a good diode should still produce a forward voltage drop reading of 0.5V to 0.8V; however, the reverse voltage drop reading can vary depending on the resistance of other pathways between the probe tips.

- Connect the test leads to the proper terminals as said above to avoid errors. The LCD will display OL to indicate that the diode being tested is open or that the polarity is reversed. The Meter will display the forward voltage drop in voltage (V) units.
- When diode testing has been completed, disconnect the connection between the testing leads and the circuit under test, and remove the testing leads away from the input terminals of the Meter.

F. Capacitance Measurement (see figure 7)

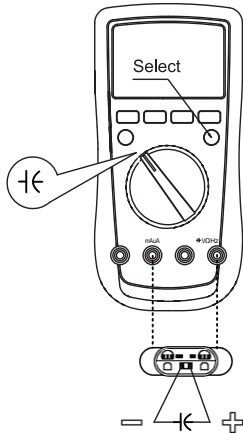

figure 7

⚠ Warning

To avoid damage to the Meter or to the equipment under test, disconnect the circuit power and discharge all high-voltage capacitors before measuring capacitance. Use the DC Voltage function to confirm that the capacitor is discharged.

To measure capacitance, connect the Meter as follows:

1. Insert the red test lead into the $\text{V}\checkmark$ terminal and the black test lead into the **COM** terminal.
2. Set the rotary switch to $\text{V}\checkmark$. On the GDM-360/397/398, press **BLUE** button to select the **nF** measurement mode.
 - At that time, the Meter will display a fixed value as shown below which is the internal capacitance of the Meter. To ensure accuracy when measuring a small value of capacitance, the tested value must be subtracted from this value. The REL mode can be used to achieve this.
GDM-360/397/398: approximately 10nF
GDM-461: approximately 50pF
 - For convenience, use the included multi-purpose socket for measuring capacitors with leads or SMT capacitors. Insert the capacitor to be tested into the corresponding “+” and “-” jack of the multi-purpose socket. This method is more stable and correct for measuring small capacitances.

3. Connect the test leads to the DUT.
The measured value shows on the display.

Note

- It takes a longer time to measure a capacitance of more than 100 μ F.
- The LCD displays **OL** to indicate that the tested capacitor is shorted or it exceeds the maximum range.
- When capacitance measurement has been completed, disconnect all the connections between the multi-purpose socket, capacitor and the Meter.

G. Frequency Measurement (see figure 8)

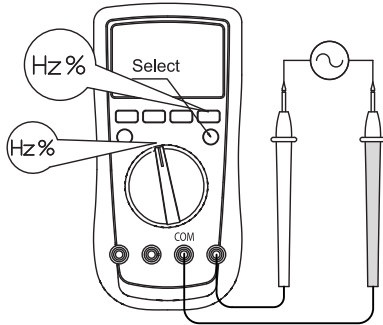

GDM-360/397/398

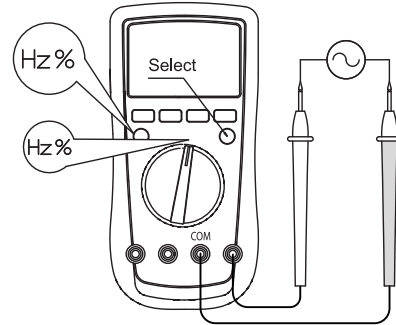

GDM-461

figure 8

⚠ Warning

To avoid personal harm, do not attempt to input more than 30V rms when testing frequency.

To measure frequency, connect the Meter as follows:

1. Insert the red test lead into the **Hz** terminal and the black test lead into the **COM** terminal.

2. Set the rotary switch to **Hz%**; frequency measurement is set to (Hz) as default, otherwise press the **Hz%** button (GDM-360/397/398) or the **yellow button** (GDM-461) to select **Hz** measurement mode.
3. Connect the test leads to the DUT.
The measured value shows on the display.
4. If you need to measure the duty cycle, press the **Hz %** button (GDM-360/397/398) or the **yellow button** (GDM-461) to select % measurement mode

Note

- Input Amplitude: (DC offset is zero)
 - GDM-360/397/398: When 10Hz ~ 10MHz: $200\text{mV} \leq a \leq 30\text{Vrms}$
 - GDM-461: When 10Hz ~ 10MHz: $300\text{mV} \leq a \leq 30\text{Vrms}$
When $\approx 10\text{MHz} \sim 40\text{MHz}$: $400\text{mV} \leq a \leq 30\text{Vrms}$
When $\geq 40\text{MHz}$: unspecified
- For GDM-461: When measuring Audio frequency, if the input voltage is more than 15volts the meter will simulate the sound at the same frequency.
- When frequency measurement has been completed, disconnect the connection between the testing leads and the circuit under test, and remove the testing leads away from the input terminals of the Meter.

H. Temperature Measurement (GDM-397 only) (see figure 9)

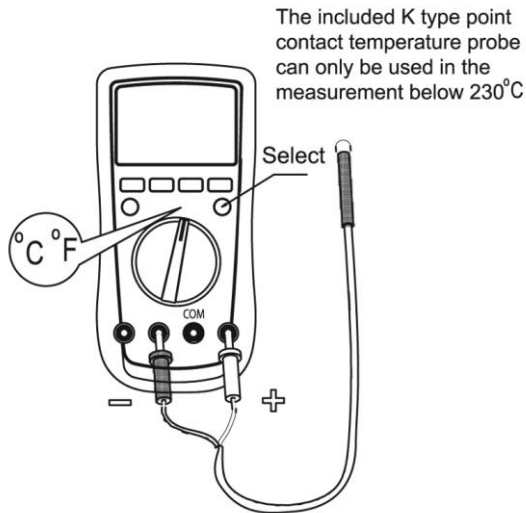

figure 9

 **Warning**

To avoid harm to yourself, do not input higher than DC 60V or AC 30V voltages.

To measure temperature, connect the Meter as follows:

1. Set the rotary switch to °C or °F
2. Insert the temperature probe into the input terminal as shown on the figure 9.
3. Place the temperature probe to the object being measured.
After few seconds, the measured value shows on the display.
4. Press **BLUE** button to toggle between °C and °F temperature.

Note

- To avoid measurement errors, especially low temperature measurement errors, ensure the operating temperature does not exceed 18 ~ 28°C.
- When temperature measurement has been completed, disconnect the connection between the temperature probe and the object being measured, and remove the temperature probe away from the input terminals of the Meter.

I. Transistor hFE Measurement (GDM-398 only) (see figure 10)

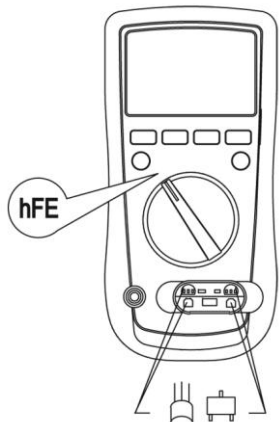

figure 10

1. Set the rotary switch to hFE.
2. Insert the multi-purpose socket into the input terminal as shown on figure 10.
3. Insert the transistor to be tested into the corresponding multi-purpose socket jacks.
4. The LCD will display hFE nearest value.

Note

- When transistor measurement has been completed, disconnect all the connections between the multi-purpose socket, transistor and the Meter.

J. EF Function (GDM-398 only) (see figure 11)

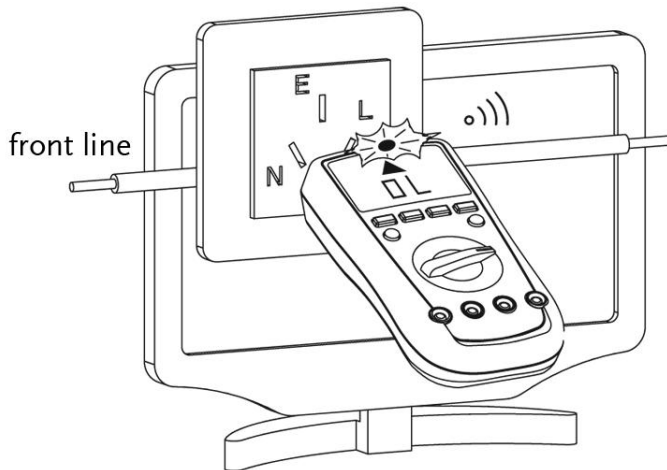



figure 11

To use the EF function, connect the Meter as follows:

1. Set the rotary switch to EF and remove the test lead from the input terminals.
2. Place the front part of the housing with the  marking towards the object being measured.
3. There will be three types of displays:
 - LCD displays different size of digits to represent the strength of detected signal.
 - When the LCD displays OL, the buzzer beeps and the red LED blinks.

Hold Mode

Warning

To avoid possibility of electric shock, do not use Hold mode to determine if circuits are without power. The Hold mode will not capture unstable or noisy readings.

The Hold mode is applicable to all measurement functions.

- Press **HOLD** to enter Hold mode; the Meter beeps.
- Press **HOLD** again to exit Hold mode; the Meter beeps.
- In Hold mode, **H** is displayed.

RANGE button

- Press **RANGE** to enter the manual ranging mode; the Meter beeps.
- Press **RANGE** to step through the ranges available for the selected function; the Meter beeps.
- Press and hold **RANGE** for over 2 seconds to return to auto ranging mode; the Meter beeps.

MAX MIN button (GDM-360/397/398 only)

- Press **MAX MIN** to start recording of maximum and minimum values. Steps the display through high (MAX) and low (MIN) readings. The Meter enters manual ranging mode after pressing **MAX MIN** button.
- Press and hold **MAX MIN** for over 2 seconds to exit MAX MIN mode and return to the present measurement range.

Peak Hold (GDM-461 only)

- Under voltage and current measurement mode, press the **PEAK** button to enter manual ranging mode and start recording of Pmax and Pmin values. The LCD displays MANU/Pmax.
- Press **PEAK** again to display MANU/Pmin.

- Press **PEAK** to step the display through Peak Max and Peak Min readings.
- Press and hold **PEAK** for over 2 seconds to exit Peak mode, the LCD displays the present measurement values.
- Don't press the "**PEAK**" key if the meter has entered "**CAL**" mode.

Outputting Data (Except GDM-398)



- Press and hold the **REL** Δ button for over 2 seconds to enter or exit RS232C or USB mode.
- The sleep mode feature will be disabled after entering RS232C or USB mode, the  icon on the LCD will disappear (GDM-397/360/398* only). *Note: for the GDM-398, entering the RS232C or USB mode has no function.
- If the Meter is carrying out HOLD, MAX/MIN or REL measurement, the LCD will display the corresponding readings (Hold, Max, Min, REL) but the interface output will output the actual measurement present on the input terminals.
- For GDM-461, Data Output mode is entered automatically.

The Use of Relative Value Mode

The REL mode applies to all measurement functions except frequency/duty cycle measurement. It subtracts a stored value from the present measurement value and displays the result.

For instance, if the stored value is 20.0V and the present measurement value is 22.0V, the reading would be 2.0V. If a new measurement value is equal to the stored value then the reading would be 0.0V.

To enter or exit REL mode:

- Press **REL**  to enter REL mode, and the present measurement is locked as the stored value. "0" is then shown on the display.
- Press **REL**  again to reset the stored value and exit REL mode.

The BLUE button

It is used for selecting the required measurement function when there is more than one function at one position of the rotary switch.

Turning on the Display Backlight (GDM-360/397/398 only)

Warning

In order to avoid mistakes arising from misread readings in insufficient light, please use the backlight function.

- Press and hold the **HOLD/LIGHT** button (yellow button) for over 2 seconds to turn the display backlight on.
- The display backlight will automatically turn off around after 10 seconds.

Sleep Mode (GDM-360/397/398 only)



To preserve battery life, the Meter automatically turns off if you do not turn the rotary switch or press any buttons after 15 minutes.

The Meter can be “woken up” by turning the rotary switch or pressing any button.

To disable the Sleep Mode function, press **BLUE** button while turning on the Meter.

GENERAL SPECIFICATIONS

- Maximum Voltage between any Terminals and Ground:
Refer to the different input ranges for the protection voltages.
- ⚠ Fused Protection for **μA mA** Input Terminal: 600mA H 1000V φ 6.35x31.8mm.
- ⚠ Fused Protection for **10A** Input Terminal: 10A H 1000V φ 10.3x38.1mm.
- Display
 - GDM-397/398: Maximum reading: 4000 (frequency 9999), analogue bar graph: 41 segments
 - GDM-360: Maximum reading: 6000 (frequency 9999), analogue bar graph: 61 segments
 - GDM-461: Maximum reading: 22000, analogue bar graph: 46 segments
- Measurement Speed: Updates 2~3 times/second.
- Range: Auto or Manual
- Polarity Display: Auto

- Overload indication: Display OL
- Battery Deficiency: Display 
- Temperature:
 - Operating: 0°C to +40°C (32°F to +104°F).
 - Storage: -10°C to +50°C (14°F to +122°F).
- Relative Humidity:
 - ≤75% @ 0°C ~ 30°C below
 - ≤50% @ 30°C - 40°C.
- Battery Type: 9V (NEDA1604 or 6F22 or 006P).
- Under the presence of electromagnetic fields, the instrument may have measurement errors. Measurement will return to normal when the interference is removed.
- Dimensions (HxWxL): 180 x 87 x 47 mm.
- Weight: Approximate 370g (battery included).
- Safety/Compliances:
EN 61010-1, EN 61010-2-030 CAT.III 1000V, CAT.IV 600V overvoltage and double insulation standard.
- Certifications: 

Accuracy Specifications

Accuracy: $\pm(a\% \text{ reading} + b \text{ digits})$, guaranteed for 1 year.

Operating temperature: $18^{\circ}\text{C} \sim 28^{\circ}\text{C}$.

Relative humidity: $<75\%$.

DC Voltage

GDM-397/398

Range	Resolution	Accuracy		Input Impedance	Fixed Value Input
		GDM-398	GDM-397		
40mV	0.01mV		$\pm(0.8\%+3)$	Around $>3000\Omega$	1000V dc/ac (Vpp)
400mV	0.1mV	$\pm(0.8\%+3)$			
4V	0.001V	$\pm(0.5\%+1)$		Around 10Ω	
40V	0.01V				
400V	0.1V				
1000V	1V	$\pm(1.0\%+3)$			

GDM-360

Range	Resolution	Accuracy	Input Impedance	Fixed Value Input
60mV	0.01mV	$\pm(0.8\%+3)$	Around >3000M Ω	1000V dc/ac (Vpp)
600mV	0.1mV	$\pm(0.8\%+3)$		
6V	0.001V	$\pm(0.5\%+1)$	Around 10M Ω	
60V	0.01V			
600V	0.1V			
1000V	1V	$\pm(1.0\%+3)$		

GDM-461

Range	Resolution	Accuracy	Input Impedance	Fixed Value Input
220mV	0.01mV	$\pm(0.1\%+5)$	Around >3000M Ω	1000V dc/ac (Vpp)
2.2V	0.0001V	$\pm(0.1\%+2)$	Around 10M Ω	
22V	0.001V			
220V	0.01V			
1000V	0.1V	$\pm(0.1\%+5)$		

AC Voltage

GDM-397/398

Range	Resolution	Accuracy 45~400Hz		Input Impedance	Fixed Value Input
		GDM-398	GDM-397		
40mV	0.01mV		$\pm(1.2\%+5)$	Around >3000M Ω	1000V dc/ 750Vrms ac
400mV	0.1mV	$\pm(1.0\%+3)$		Around 10M Ω	
4V	0.001V				
40V	0.01V				
400V	0.1V				
750V	1V	$\pm(1.2\%+5)$			

- Displays effective value of a sine wave. mV range is applicable from 5% of range to 100% of range.

GDM-360

Range	Resolution	Accuracy		Input Impedance	Fixed Value Input
		45~1kHz	>1kHz~3kHz		
60mV	0.01mV	$\pm (1.2\%+5)$	$\pm (2.0\%+5)$	Around >3000M Ω	1000V dc/ 750Vrms ac
600mV	0.1mV				
6V	0.001V	$\pm (1.0\%+3)$	$\pm (1.5\%+5)$	Around 10M Ω	
60V	0.01V				
600V	0.1V				
750V	1V	$\pm (1.2\%+5)$	$\pm (3.0\%+5)$		

- GDM-360:
 - True RMS is applicable from 10% of range to 100% of range.
 - AC crest factor can be up to 3.0 except 750V where it is 1.5.
 - A residual reading of 10 digits with test leads shorted, will not affect stated accuracy.

GDM-461

Range	Resolution	Accuracy		Input Impedance	Fixed Value Input
		45~1kHz	>1kHz~10kHz		
220mV	0.01mV	$\pm(1.0\%+10)$	$\pm(1.5\%+50)$	Around >3000M Ω	1000V dc/ 750Vrms ac
2.2V	0.0001V	$\pm(0.8\%+10)$	$\pm(1.2\%+50)$	Around 10M Ω	
22V	0.001V				
220V	0.01V				
750V	0.1V	$\pm(1.2\%+10)$	$\pm(3.0\%+50)$		

- True RMS is applicable from 10% of range to 100% of range.
- AC crest factor can be up to 3.0 except 750V where it is 1.5.
- A residual reading of 10 digits with test leads shorted, will not affect stated accuracy.

DC Current

GDM-397/398

Range	Resolution	Accuracy	Overload Protection
400 μ A	0.1 μ A	$\pm(1.0\%+2)$	Fuse 1: F600mA H 1000V, ϕ 6.35 x 31.8mm
4000 μ A	1 μ A		
40mA	0.01mA	$\pm(1.2\%+3)$	
400mA	0.1mA		
4A	0.001A	$\pm(1.5\%+3)$	Fuse 2: F10A H 1000V, ϕ 10.3 x 38.1mm
10A	0.01A		

Remarks:

- When $\leq 5A$: Continuous measurement is allowed.
- When $>5A$: Continuous measurement for less than 10 seconds with intervals of more than 15 minutes between measurements.

GDM-360

Range	Resolution	Accuracy	Overload Protection
600 μ A	0.1 μ A	$\pm(1.0\%+3)$	Fuse 1: F600mA H 1000V, ϕ 6.35 x 31.8mm
6000 μ A	1 μ A		
60mA	0.01mA		
600mA	0.1mA		
6A	0.001A	$\pm(1.2\%+5)$	Fuse 2: F10A H 1000V, ϕ 10.3 x 38.1mm
10A	0.01A		

Remarks:

- When $\leq 5A$: Continuous measurement is allowed.
- When $> 5A$: Continuous measurement for less than 10 seconds with intervals of more than 15 minutes between measurements.

GDM-461

Range	Resolution	Accuracy	Overload Protection
220 μ A	0.01 μ A	$\pm(0.5\%+10)$	Fuse 1: F600mA H 1000V, ϕ 6.35 x 31.8mm
2200 μ A	0.1 μ A		
22mA	0.001mA		
220mA	0.01mA		
10A	0.001A	$\pm(1.2\%+50)$	Fuse 2: F10A H 1000V, ϕ 10.3 x 38.1mm

Remarks:

- When $\leq 5A$: Continuous measurement is allowed.
- When $> 5A$: Continuous measurement for less than 10 seconds with intervals of more than 15 minutes between measurements.

AC Current

GDM-397/398

Range	Resolution	Accuracy 45Hz~400Hz	Overload Protection
400 μ A	0.1 μ A	$\pm(1.2\%+5)$	Fuse 1: F600mA H 1000V, ϕ 6.35 x 31.8mm
4000 μ A	1 μ A		
40mA	0.01mA	$\pm(1.5\%+5)$	
400mA	0.1mA		
4A	0.001A	$\pm(2.0\%+5)$	Fuse 2: F10A H 1000V, ϕ 10.3 x 38.1mm
10A	0.01A		

Remarks:

- When $\leq 5A$: Continuous measurement is allowed.
- When $> 5A$: Continuous measurement for less than 10 seconds with intervals of more than 15 minutes between measurements.
- Displays the effective value of a sine wave.

GDM-360

Range	Resolution	Accuracy		Overload Protection
		45~1kHz	1kHz~3kHz	
600 μ A	0.1 μ A	$\pm(1.2\%+5)$	$\pm(1.5\%+5)$	Fuse 1: F600mA H 1000V, ϕ 6.35 x 31.8mm
6000 μ A	1 μ A			
60mA	0.01mA	$\pm(1.5\%+5)$	$\pm(2.0\%+5)$	
600mA	0.1mA			
6A	0.001A	$\pm(2.0\%+5)$	$\pm(3.0\%+5)$	Fuse 2: F10A H 1000V, ϕ 10.3 x 38.1mm
10A	0.01A			

Remarks:

- When $\leq 5A$: Continuous measurement is allowed.
- When $> 5A$: Continuous measurement for less than 10 seconds with intervals of more than 15 minutes between measurements.
- GDM-360:
 - True RMS is applicable from 10% of range to 100% for range.
 - A residual reading of 10 digits with test leads shorted, will not affect stated accuracy.

GDM-461

Range	Resolution	Accuracy		Overload Protection
		45~1kHz	>1kHz~10kHz	
220 μ A	0.01 μ A	$\pm(0.8\%+10)$	$\pm(1.2\%+50)$	Fuse 1: F600mA H 1000V, ϕ 6.35 x 31.8mm
2200 μ A	0.1 μ A			
22mA	0.001mA	$\pm(1.2\%+10)$	$\pm(1.5\%+50)$	
220mA	0.01mA			
10A	0.001A	$\pm(1.5\%+10)$	>1kHz~5kHz	Fuse 2: F10A H 1000V, ϕ 10.3 x 38.1mm
			$\pm(2.0\%+50)$	

Remarks:

- When $\leq 5A$: Continuous measurement is allowed.
- When $> 5A$: Continuous measurement for less than 10 seconds with intervals of more than 15 minutes between measurements.
- True RMS is applicable from 10% of range to 100% of range.
- A residual reading of 10 digits with test leads shorted, will not affect stated accuracy.

Resistance

GDM-397/398

Range	Resolution	Accuracy	Overload Protection	Remark
400Ω	0.1Ω	±(1.2%+2)	1000V dc / ac (Vpp)	When measuring below 2kΩ, apply REL Δ to ensure measurement accuracy.
4kΩ	0.001kΩ	±(1.0%+2)		
40kΩ	0.01kΩ			
400kΩ	0.1kΩ			
4MΩ	0.001MΩ	±(1.2%+2)		
40MΩ	0.01MΩ	±(1.5%+2)		

GDM-360

Range	Resolution	Accuracy	Overload Protection	Remark
600Ω	0.1Ω	±(1.2%+2)	1000V dc / ac (Vpp)	When measuring below 2kΩ, apply REL Δ to ensure measurement accuracy.
6kΩ	0.001kΩ	±(1.0%+2)		
60kΩ	0.01kΩ			
600kΩ	0.1kΩ			
6MΩ	0.001MΩ	±(1.2%+2)		
60MΩ	0.01MΩ	±(1.5%+2)		

GDM-461

Range	Resolution	Accuracy	Overload Protection	Remark
220Ω	0.01Ω	±(0.5%+10)	1000V dc / ac (Vpp)	When measuring below 2kΩ, apply REL Δ to ensure measurement accuracy.
2.2kΩ	0.0001kΩ			
22kΩ	0.001kΩ			
220kΩ	0.01kΩ	±(0.8%+10)		
2.2MΩ	0.0001MΩ			
22MΩ	0.001MΩ	±(1.5%+10)		
220MΩ	0.01MΩ	±(3.0%+50)		

Capacitance

GDM-397/398

Range	Resolution	Accuracy	Overload Protection	Remark
40nF	0.01nF	±(3.0%+5)	1000V dc / ac (Vpp)	There is around 10nF residual reading when the circuit is open
400nF	0.1nF			
4μF	0.001μF			
40μF	0.01μF	±(4.0%+5)		
400μF	0.1μF			
4000μF	1μF	unspecified		

GDM-360

Range	Resolution	Accuracy	Overload Protection	Remark
40nF	0.01nF	±(3.0%+5)	1000V dc / ac (Vpp)	There is around 10nF residual reading when the circuit is open
400nF	0.1nF			
4μF	0.001μF			
40μF	0.01μF			
400μF	0.1μF	±(4.0%+5)		
4000μF	1μF	unspecified		

GDM-461

Range	Resolution	Accuracy	Overload Protection	Remark
22nF	0.001nF	±(3.0%+5)	1000V dc / ac (Vpp)	There is around 50pF residual reading when the circuit is open.
220nF	0.01nF			
2.2μF	0.0001μF			
22μF	0.001μF			
220μF	0.01μF	±(4.0%+5)		
2.2mF	0.0001mF			
22mF	0.001mF	unspecified		
220mF	0.01mF			

To measure a small value of capacitance, use REL Δ to ensure accuracy.

Frequency

Model	Range	Accuracy	Maximum Resolution
GDM-397/398/360	10Hz~10MHz	$\pm(0.1\%+4)$	0.01Hz
GDM-461	10Hz~220MHz	$\pm(0.01\%+5)$	0.001Hz

- Overload Protection: 1000Vdc/ ac (Vpp)
- Input Amplitude: (DC offset is zero)
 - GDM-360/397/398:
 - When 10Hz ~ 10MHz: $200\text{mV} \leq a \leq 30\text{Vrms}$
 - GDM-461:
 - When 10Hz ~ 10MHz: $300\text{mV} \leq a \leq 30\text{Vrms}$
 - When > 10MHz ~ 40MHz: $400\text{mV} \leq a \leq 30\text{Vrms}$
 - When > 40MHz: unspecified
 - When measuring on line frequency or duty cycle under AC Voltage and Current measurement mode, the input amplitude and frequency response must satisfy the following requirement:
 - Input amplitude $\geq \text{range} \times 30\%$
 - Frequency response: GDM-397/398: $\leq 400\text{Hz}$
 - GDM-360/461: $\leq 1\text{kHz}$

Diode Test

Model	Resolution	Remarks	Overload Protection
GDM-360/397/398	0.001V	Open circuit voltage around 2.8V	1000Vdc / ac (Vpp)
GDM-461	0.0001V		

Continuity Test

Model	Resolution	Overload Protection
GDM-360/397/398	0.1 Ω	1000Vdc / ac (Vpp)
GDM-461	0.01 Ω	

- GDM-360/397/398:
 - Open circuit voltage is around 0.45V.
 - Broken circuit resistance value is around $> 35\Omega$, the buzzer does not beep.
 - Good circuit resistance value is $\leq 10\Omega$, the buzzer beeps continuously.
- GDM-461:
 - Open circuit voltage is around -3V.
 - Broken circuit resistance value is around $> 30\Omega$, the buzzer does not beep.
 - Good circuit resistance value is ≤ 10 , the buzzer beeps continuously.

Temperature Measurement (GDM-397 only)

Range	Resolution	Accuracy	Overload Protection
°C	1°C	(-40~-20°C): -(8%+5)	1000Vdc / ac (Vpp)
		(>-20~0°C): ±(1.2%+4)	
		(>0~100°C): ±(1.2%+3)	
		(>100~1000°C): ±(2.5%+2)	
°F	1°F	(-40~4°F): -(8%+6)	
		(>4~32°F): ±(1.2%+5)	
		(>32~212°F): ±(1.2%+4)	
		(>212~1832°F): ±(2.5%+3)	

- Thermocouple:

It is suitable to use K-type thermocouples. The included K-type thermocouple can only be used to measure temperatures less than 230°C.

Transistor hFE (GDM-398 only)

Range	Resolution	Remark
hFE	1β	I _{bo} ≈10μA; 1000β MAX

M AINTENANCE

This section provides basic maintenance information including battery and fuse replacement instructions.

Warning

Do not attempt to repair or service your Meter unless you are qualified to do so and have the relevant calibration, performance test, and service information.

To avoid electrical shock or damage to the Meter, do not get water inside the case.

General Service

- Periodically wipe the case with a damp cloth and mild detergent. Do not use abrasives or solvents.
- Clean the terminals using cotton tips with detergent, as dirt or moisture in the terminals can affect readings.
- Turn off the power when it is not in use.
- Take out the battery when it has not been used for a long time.

- Do not use or store the Meter in a place of humidity, high temperature or in the presence of explosives, inflammable materials and strong magnetic fields.

Replacing the Battery

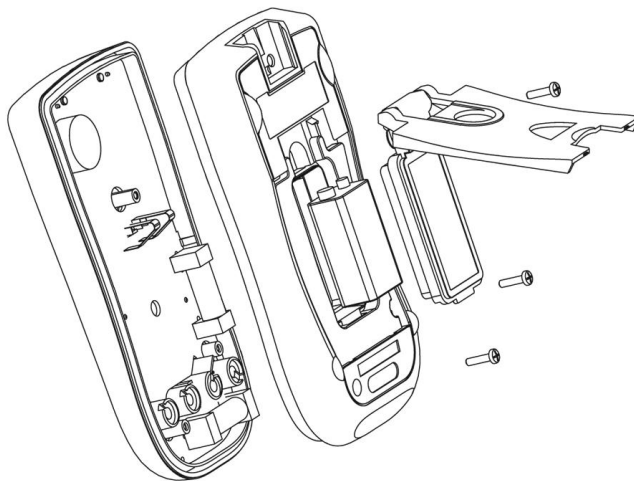



figure 12

**Warning**

To avoid false readings, which could lead to possible electric shock or personal injury, replace the battery as soon as the battery indicator “” appears.

Make sure the test leads are disconnected from the circuit being tested before opening the case bottom.

To replace the battery: (See figure 12)

1. Turn the Meter power off and remove all connections from the terminals.
2. Remove the screw from the tilt stand and the battery compartment and then separate the battery compartment and the tilt stand from the case bottom.
3. Remove the battery from the battery compartment.
4. Replace the battery with a new 9V battery.
5. Rejoin the tilt stand, battery compartment and case bottom, and reinstall the screw.

Replacing the Fuses

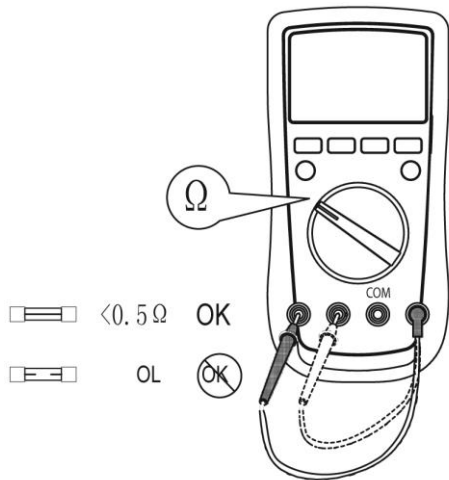

figure 13

⚠ Warning

To avoid electrical shock or arc blast, or personal injury or damage to the Meter, use specified fuses **ONLY** in accordance with the following procedure.

To test the fuse: (See figure 13)

If the Meter does not respond when measuring current or transistor hFE, inspect to see that the fuses aren't broken.

To replace the Meter's fuse: (See figure 12)

1. Turn the Meter power off and remove all the connections from the terminals.
2. Remove the screw from the tilt stand and the battery compartment and separate the battery compartment and the tilt stand from the case bottom.
3. Remove the two screws from the case bottom, and the separate the case top from the case bottom.
4. Remove the fuse by gently prying one end loose, then take out the fuse from its bracket.
5. **ONLY** install replacement fuses of an identical type and specification as shown below and make sure the fuse is fixed firmly in the bracket.
 $\mu\text{A}/\text{mA}$ range: F1, 600mA H 1000V, ϕ 6.35x31.8mm (CE)

10A range: F2, 10A H 1000V, ϕ 10.3x38.1mm. (CE)

6. Rejoin the case bottom and case top, and reinstall the screw.
7. Rejoin the tilt stand, battery compartment and case bottom, and reinstall the screw.

USB and RS232C Serial Port

USB is optional at extra cost.

Please refer to the **“Installation Guide & Computer Interface Software”** for installing and operating instructions for the **GDM-360/397/461 Interface Program**.