



testo 330-1, -2, -3 / testo 330-1 $L$ , -2 $L$   
Flue gas analyser

Instruction manual

en



205 Westwood Ave  
Long Branch, NJ 07740  
1-877-742-TEST (8378)  
Fax: (732) 222-7088  
salesteam@Tequipment.NET









# General notes

Please read this documentation through carefully and familiarise yourself with the operation of the product before putting it to use. Keep this document to hand so that you can refer to it when necessary.

The document describes the country-specific version **D** of the testo 330-1, -2, -3 and testo 330-1 LL, -2 LL products.



## Identification

Symbol	Meaning	Comments
 Warning!	Warning advice: Warning! Serious physical injury could be caused if the specified precautionary measures are not taken.	Read the warning advice carefully and take the specified precautionary measures!
 Caution!	Warning advice: Caution! Slight physical injury or damage to equipment could occur if the specified precautionary measures are not taken.	Read the warning advice carefully and take the specified precautionary measures!
	Important.	Please pay particular attention.
<b>(testo 330-1)</b>	The description applies only for the instrument indicated: testo 330-1, -2, -3 / testo 330-1 LL, -2 LL.	-
<b>Text</b>	Text appears on the instrument's display	-
	Key	Press the key.
	Function key with the function "OK".	Press function key.
 → xyz	Short form for operating steps.	See <i>short form</i> , p. 3.







### Short form

This document uses a short form for describing operating steps (e.g. calling up a function).

Example: Calling up the **Flue gas** function

Short form:  → **Measurements** →  → **Flue gas** →   
(1) (2) (3) (4) (5)

Steps required:

- 1 Open main menu: .
- 2 Select **Measurements** menu: , .
- 3 Confirm selection: .
- 4 Select **Flue gas** menu: , .
- 5 Confirm selection: .



# Contents

**!** See also *Functional overview*, p. 60.

<b>General notes</b>	<b>2</b>
<b>Contents</b>	<b>4</b>
<b>A. Safety advice</b>	<b>7</b>
<b>B. Intended purpose</b>	<b>9</b>
<b>C. Product description</b>	<b>10</b>
C.1 Measuring instrument	10
C.1.1 Overview	10
C.1.2 Keypad	11
C.1.3 Display	11
C.1.4 Device connections	12
C.1.5 Interfaces	13
C.1.6 Components	13
C.1.7 Carrying strap/barcode pen holder	14
C.2 Modular flue gas probe	15
<b>D. Commissioning</b>	<b>16</b>
<b>E. Operation</b>	<b>17</b>
E.1 Mains unit/rechargeable battery	17
E.1.1 Changing the battery	17
E.1.2 Charging batteries	18
E.1.3 Operation with the mains unit	18
E.2 Probes/Sensors	19
E.2.1 Connecting probes/sensors	19
E.2.2 Replacing the probe module	20
E.3 Regular care	20
E.3.1 Condensate trap	20
E.3.2 Checking/replacing the particle filter	21

E.4	Basic operating steps .....	21
E.4.1	Switching the measuring instrument on .....	21
E.4.2	Calling up a function .....	22
E.4.3	Entering values .....	22
E.4.4	Printing data .....	23
E.4.5	Saving data .....	23
E.4.6	Confirming an error message .....	23
E.4.7	Scanning locations with the barcode pen .....	24
E.4.8	Switching the measuring instrument off .....	24
E.5	Memory/Location .....	24
E.6	Instrument diagnosis .....	26
<b>F.</b>	<b>Configuration .....</b>	<b>28</b>
F.1	Instrument settings .....	28
F.1.1	Display edit .....	28
F.1.2	Printer .....	29
F.1.3	Alarm limits .....	30
F.1.4	Start Keys edit .....	30
F.1.5	Communication .....	31
F.1.6	Date/Time .....	31
F.1.7	Language .....	31
F.2	Sensor settings .....	32
F.3	Fuels .....	33
<b>G.</b>	<b>Measuring .....</b>	<b>34</b>
G.1	Preparing measurements .....	34
G.1.1	Zeroing phases .....	34
G.1.2	Using the modular flue gas probe .....	35
G.1.3	Configuring the reading display .....	35
G.1.4	Set memory/location .....	35



## 6 Contents

G.2	Measurements .....	36
G.2.1	Flue gas .....	36
G.2.2	Draught .....	37
G.2.3	Fine pressure probe (accessory) .....	37
G.2.4	BlmSchV (testo 330-3 / testo 330-2LL) .....	38
G.2.5	CO undiluted .....	40
G.2.6	Smoke No./HCT .....	40
G.2.7	Differential pressure .....	41
G.2.8	Differential temperature .....	42
G.2.9	O <sub>2</sub> air .....	42
G.2.10	Gas flow rate .....	43
G.2.11	Oil flow rate .....	43
G.2.12	Leak detection .....	44
G.2.13	Ambient CO .....	44
G.2.14	Ambient CO <sub>2</sub> .....	45
G.2.15	Burner control .....	46
H.1	Protocol printer .....	48
H.2	PC/Pocket PC .....	48
<b>I.</b>	<b>Care and maintenance .....</b>	<b>49</b>
I.1	Cleaning the measuring instrument .....	49
I.2	Replacing measuring cells .....	49
I.3	Recalibrating measuring cells .....	50
I.4	Replacing additional filter .....	50
I.5	Cleaning the modular flue gas probe .....	51
I.6	Changing the thermocouple .....	51
<b>J.</b>	<b>Questions and Answers .....</b>	<b>52</b>
<b>K.</b>	<b>Technical data .....</b>	<b>52</b>
K.1	Standards and inspections .....	52
K.2	Measuring ranges and accuracies .....	53
K.3	Other device data .....	54
K.5	Principles of calculation .....	56
K.5.1	Fuel parameters .....	56
K.5.2	Calculation formulae .....	56
<b>L.</b>	<b>Accessories/Spare parts .....</b>	<b>58</b>
	<b>Functional overview .....</b>	<b>60</b>

# A. Safety advice



## Avoid electrical hazards:

- ▶ Never use the measuring instrument and probes to measure on or near live parts!



## Protect the measuring instrument:

- ▶ Never store the instrument/measuring cells together with solvents (e.g. acetone). Do not use any desiccants.



## Product with **Bluetooth®** (Option)

Changes or modifications, which are not expressly approved by the responsible official body, can lead to a withdrawal of operating permission.

Interference with data transfer can be caused by instruments which transmit on the same ISM band, e.g. microwave ovens, ZigBee.

The use of radio connections is not allowed in e.g. aeroplanes and hospitals. For this reason, the following point must be checked before entering:

- ▶ Deactivate Bluetooth function:

 → **Inst' settings** → **OK** → **Communication** → **OK** → **IrDA** → **OK**.



## Product safety/preserving warranty claims:

- ▶ Operate the measuring instrument only within the parameters specified in the technical data.
- ▶ Handle the instrument properly and according to its intended purpose.
- ▶ Never apply force!
- ▶ Temperatures given on probes/sensors relate only to the measuring range of the sensors. Do not expose handles and feeders to any temperatures in excess of 70 °C unless they are expressly permitted for higher temperatures.
- ▶ Open the measuring instrument only when this is expressly described in the Operating Instructions for maintenance purposes.
- ▶ Carry out only the maintenance and repair work that is described in the Operating Instructions. Follow the prescribed steps exactly. For safety reasons, use only original spare parts from Testo.



## 8 A. Safety advice

- ▶ Any further or additional work must only be carried out by authorised personnel. Testo will otherwise refuse to accept responsibility for the proper functioning of the measuring instrument after repair and for the validity of certifications.



### **Ensure correct disposal:**

- ▶ Dispose of defective rechargeable batteries and spent batteries at the provided collection points.
- ▶ Send the measuring instrument directly to us at the end of its life cycle. We will ensure that it is disposed of in an environmentally friendly manner.



## B. Intended purpose

*This chapter describes the areas of application for which the measuring instrument is intended.*

The testo 330 is a handheld measuring device for the professional flue gas analysis of furnace systems:

- Small furnaces (burning oil, gas, wood, coal)
- Low-temperature and condensing boilers
- Gas heaters

These systems can be adjusted using the testo 330 and checked for compliance with the applicable limit values.

The measuring instrument is approved for measurements under the German regulations on immissions protection (1. BImSchV).

The following tasks can also be carried out with the testo 330:

- Regulating the O<sub>2</sub>-, CO- and CO<sub>2</sub>-, NO-, NO<sub>x</sub> values in furnaces for the purpose of ensuring optimal operation.
- Draught measurement.
- Measuring and regulating the gas flow pressure in gas heaters.
- Measuring and optimising the flow and return temperatures of heating systems.
- CO- and CO<sub>2</sub> environment measurement.
- Detection of CH<sub>4</sub> (methane) and C<sub>3</sub>H<sub>8</sub> (propane).

testo 330 should not be used:

- for continuous measurements
- as a safety (alarm) instrument

**!** The testo 330 with the Bluetooth option may only be operated in countries in which it is type approved (see Technical Data).

# C. Product description

*This chapter provides an overview of the individual components of the product.*

## C.1 Measuring instrument

### C.1.1 Overview



- ① Switch on/off
- ② Interfaces: USB, PS2, infrared
- ⚠ Do not direct infrared beam at human eyes.
- ③ Condensate trap (on rear)
- ④ Fixing eyelets for carrying strap (left and right)
- ⑤ Display
- ⑥ Magnetic holders (on rear)



Strong magnets

#### Damage to other magnets

- ▶ Keep safe distance from products which could be damaged by magnets (e.g. monitors, computers, pacemakers, credit cards).

- ⑦ Keypad
- ⑧ Service cover (on rear)
- ⑨ Gas outlet
- ⑩ Unit connections: flue gas probe, probe, pressure probe, mains unit

## C.1.2 Keypad

Key	Functions
	Switch measuring instrument on/off
	Function key (orange, 3x), relevant function is shown on the display
	Scroll up, increase value
	Scroll down, reduce value
	Back, cancel function
	Open <b>Main menu</b> : press briefly (changed settings are stored, measurement values are carried over into the menu <b>Flue gas</b> ); open <b>Measurements</b> menu: press and hold down for 2s (changed settings are stored, measurement values are carried over into the menu <b>Flue gas</b> )
	Open <b>Inst' diagnosis</b> menu
	Switch over display light: display light is permanently on or display light goes on for 10 seconds everytime a key is activated.

## C.1.3 Display

Depending on the menu that is active, the display shows a variety of elements.

### Header (active in all views)

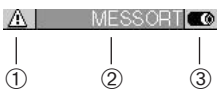

- ① Warning symbol (only if there is a device error; the device error is displayed in the **Inst' diagnosis** menu).
- ② Active location.
- ③ Power supply symbol:

Symbol	Characteristic	Symbol	Characteristic
	Mains operation		Rech. battery operation, capacity: 26-50%
	Rech. battery operation, capacity: 76-100%		Rech. battery operation, capacity: 6-25%
	Rech. battery operation, capacity: 51-75%		Rech. battery operation, capacity: 0-5%

### Function select view

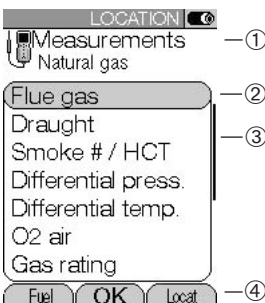

- ① Active menu, activated fuel
- ② Selection field for functions:  
The chosen function is shown with a grey background.  
Unavailable functions are written in grey type.
- ③ Scroll bar
- ④ Function keys for entering commands

**Settings view**

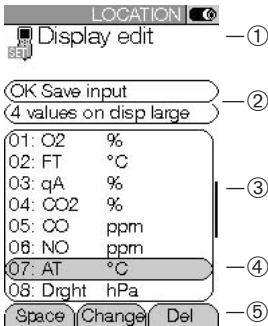

- ① Active menu
- ② Function fields for entering commands
- ③ Scroll bar
- ④ Selection field for adjustable values:  
The chosen value is shown with a grey background. Unavailable values are written in grey type.
- ⑤ Function keys for entering commands

**Measuring view**

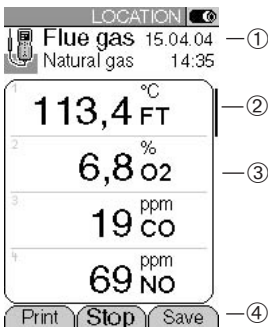

- ① Active menu, depending on the chosen function:  
Additional information (e.g. activated fuel, date and time)
- ② Scroll bar
- ③ Display field for readings, parameters
- ④ Function keys for entering commands

**C.1.4 Device connections**



- ① Probe socket
- ② Flue gas socket
- ③ Mains unit socket
- ④ Pressure socket

## C.1.5 Interfaces



- ① USB interface:  
connection to PC
- ② PS2 interface:  
connection to barcode pen, adapter for automatic furnaces
- ③ Infrared interface (IrDA):  
connection to Testo-printers/Pocket PC

## C.1.6 Components

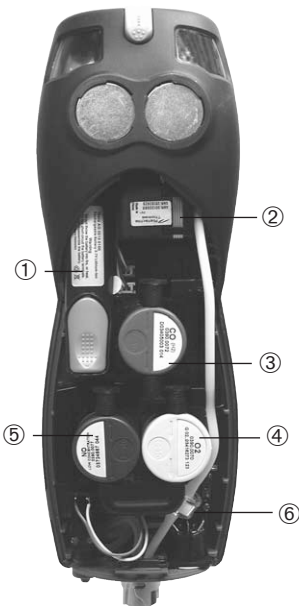

- ① Rechargeable battery
- ② Measuring gas pump
- ③ Slot for CO measuring cell
- ④ Slot for O<sub>2</sub> measuring cell
- ⑤ Slot for NO-, NO low measuring cell
- ⑥ Additional filter

### C.1.7 Carrying strap/barcode pen holder

To secure the carrying strap:

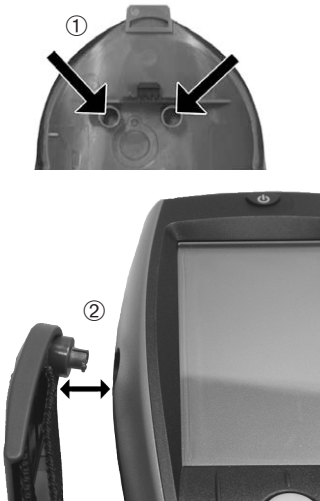

- 1 Remove sealing caps from the sides of the housing.

**Fix sealing caps on the inside of the service cover:**

- 1 Place the measuring instrument on its front.
  - 2 Pick the service cover up at the markings (arrows) using your index finger and thumb and press gently to release the lock.
  - 3 Fold the service cover up and remove it.
  - 4 Secure the sealing caps in the two holders on the inside of the service cover (①).
  - 5 Attach the service cover and engage it in place.
- 2 Engage the carrying strap clip in the fixing eyelets on the side of the device. Note the guide groove. The strap must point “down” (②).

To secure the barcode pen holder to the carrying strap:

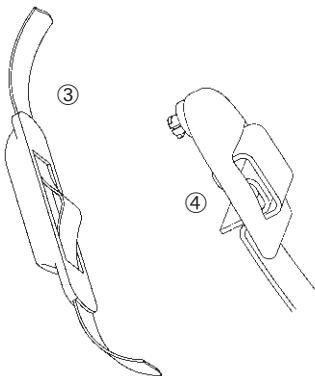

- 1 Loosen the carrying strap at the buckle and remove.
- 2 Lead carrying strap through the strap guide of the barcode pen holder (③).
- 3 Lead carrying strap through the buckle (④) and tighten.

## C.2 Modular flue gas probe

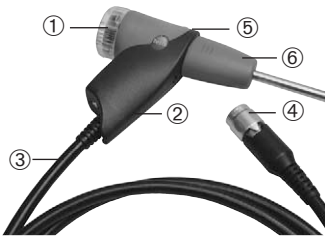

- ① Removable filter chamber with window and particle filter
- ② Probe handle
- ③ Connecting cable
- ④ Connecting plug for measuring instrument
- ⑤ Probe module lock release
- ⑥ Probe module

## D. Commissioning

*This chapter describes the steps required to commission the product.*

- ▶ Remove the protective film from the display.

The measuring instrument is supplied with a rechargeable battery already fitted.

- ▶ Charge the battery up fully before using the instrument (see *Charging batteries*, p. 18).



# E. Operation

*This chapter describes the steps that have to be executed frequently when using the product.*

**!** Please read this chapter carefully. The following chapters of this document will assume you are already familiar with the content of this chapter.

## E.1 Mains unit/rechargeable battery

If the mains unit is connected, the measuring instrument is automatically powered from the unit. It is not possible to charge the battery in the instrument during operation.

### E.1.1 Changing the battery

**!** The measuring instrument must not be connected to a mains socket via the mains unit. The instrument must be switched off. Change the rechargeable battery within 60 minutes so that device settings (e.g. date/time) are not lost.

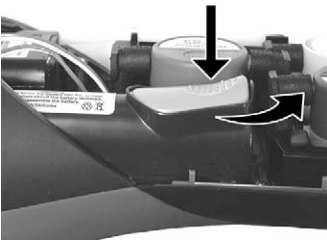

- 1 Place the measuring instrument on its front.
- 2 Remove the service cover: Take hold of it at the markings (arrows) using the index finger and thumb, press slightly, fold up and remove.
- 3 Open the battery lock: Press the orange key and push in the direction of the arrow.
- 4 Remove the battery and insert a new rechargeable battery. Only use the Testo rechargeable battery 0515 0100.
- 5 Close battery lock: Press the orange key and push against the direction of the arrow until the battery engages.
- 6 Attach the service cover and engage it in place.

## E.1.2 Charging batteries

The rechargeable battery can only be charged at an ambient temperature of  $\pm 0$  to  $+35$  °C. If the battery has discharged completely, the charging time at room temperature is approximately 5-6 h.

### Charging in the measuring instrument

**!** The instrument must be switched off.

- 1 Connect the plug of the mains unit to the mains unit socket on the measuring instrument.
- 2 Connect the mains plug of the mains unit to a mains socket.
  - The charging process will start. The charge condition will be shown on the display. The charging process will stop automatically when the battery is fully charged.

### Recharging in the charging station (0554 1087)

- ▶ Refer to the documentation enclosed with the charging station.

### Battery care

- ▶ If possible, always discharge the battery and recharge it fully.
- ▶ Do not store the battery for long periods when discharged. (The best storage conditions are at 50-80% charge level and 10-20 °C ambient temperature; charge fully before further use).

## E.1.3 Operation with the mains unit

- 1 Connect the plug of the mains unit to the mains unit socket on the measuring instrument.
- 2 Connect the mains plug of the mains unit to a mains socket.
  - The measuring instrument is powered via the mains unit.
  - If the instrument is switched off and a rechargeable battery is inserted, the charging process will start automatically. Switching the instrument on has the effect of stopping battery charging and the instrument is then powered via the mains unit.

## E.2 Probes/Sensors

### E.2.1 Connecting probes/sensors

#### ! Probe socket:

Probe detection is carried out at the socket during the initial switch on activation process: Probes that are required must always be connected before the measuring instrument is switched on, or the instrument must be switched off and then on again after a change of probe, so that the correct data can be read into the instrument.

#### Flue gas socket:

Probe/sensor detection at the flue gas socket is carried out continuously. It is possible to change the probe/sensor even while the measuring instrument is switched on.

#### Connect flue gas probes/gas pressure adapters/temperature adapters



- ▶ Insert the connector into the flue gas socket and lock by turning it clockwise gently (bayonet lock).

- ! Only one hose extension (0554 1201) should be connected between the measuring instrument and the flue gas probe.

#### Connecting other probes



- ▶ Insert the connector of the probe into the probe socket.

#### Connecting the pressure hose



- ▶ Fit the pressure hose on the connecting nipple of the pressure socket.

## E.2.2 Replacing the probe module

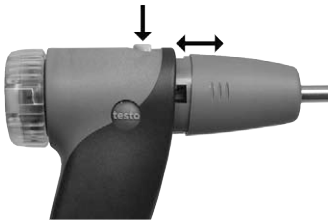

- 1 Press the key on the top of the probe handle and remove the probe module.
- 2 Fit a new probe module and engage it in place.

## E.3 Regular care

### E.3.1 Condensate trap

The fill level of the condensate trap can be read from the markings on the trap. A warning message (⚠ red flashing light) is displayed if the level in the condensate trap reaches 90%.

#### Emptying the condensate trap

! The condensate consists of a weak mix of acids. Avoid contact with the skin. Make sure that the condensate does not run over the housing.



Caution!

Condensate in gas path.

#### Damage to measuring cells and flue gas pump.

- ▶ Do not empty condensate trap while pump is operating.



- 1 Hold the measuring instrument so that the condensate outlet points up.
- 2 Open condensate outlet in condensate trap: Pull out approx. 5mm or until it will not go any further (①).
- 3 Let the condensate run out into a sink (②).
- 4 Dab off drops at condensate outlet using a cloth.
- 5 Close the condensate outlet.

! The condensate outlet must be fully closed (marking) otherwise incorrect measurements due to inleaking air may result.

## E.3.2 Checking/replacing the particle filter

### Checking the particle filter:



- ▶ Particle filters of the modular flue gas probe must be checked regularly for contamination: Check visually by looking through the window of the filter chamber. Replace the filter if there are signs of contamination.

### Replacing the particle filter:

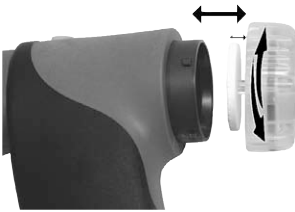

- ! Filter chamber may contain condensate.
- 1 Open the filter chamber: Turn gently anticlockwise.
- 2 Remove the filter plate and replace it with a new one (0554 3385).
- 3 Fit the filter chamber and lock it: Turn gently clockwise.

## E.4 Basic operating steps

### E.4.1 Switching the measuring instrument on



- The start screen is displayed (for about 5 s).
- Display illumination is switched on for 10 s.

#### Option:

- ▶ To go directly to a measurement while the start screen is being displayed, press the function key for the desired measurement. See also *Start key configuration*, p. 30.

- The **Measurements** menu is opened.

-or-

- If another probe/sensor is connected rather than a flue gas probe: the measuring menu for that probe/sensor is opened.

-or-

- If the power supply was interrupted for a longer period: the **Date/Time** menu is opened.

-or-

- There is an instrument error: **Error diagnosis** is displayed.

## E.4.2 Calling up a function

**!** Functions which cannot be selected, because the required probe/sensor is not connected, are shown in grey type.

1 Select the function: , .

- The chosen function is shown with a grey background.

2 Confirm selection: .

- The chosen function is opened.

## E.4.3 Entering values

Some functions require values (numbers, units, characters) to be entered. Depending on the function that is chosen, the values are entered via either a list field or an input editor.

### List field



1 Select the value to be changed (number, unit):



2 Set the value: , .

3 Repeat steps 1 and 2 as required.

4 Confirm the input: .

5 Save the input: **OK Save input** → .

## Input editor



- 1 Select the value (character): , , , .
- 2 Accept the value: .

### Options:

- ▶ To switch between upper-case/lower-case letters: **A <=> a** (not always available).
  - ▶ To delete characters: **<=**.
  - ▶ To position the cursor in the text: Select the text input field: , and position the cursor: , .
  - ▶ To delete characters in front of the cursor: .
- 3 Repeat steps 1 and 2 as required.
  - 4 Save the input: **OK Save input** → .

## E.4.4 Printing data

Data are printed out via the function key . The function is only available if a printout is possible.

If data are to be transferred to a protocol printer via the infrared interface, the printer that is to be used must be activated, see *Printer*, p. 29.

## E.4.5 Saving data

Data are saved either via the function key or the function field **OK Save input**. The functions are only available if saving is possible.

See also *Memory/Location*, p. 24.

## E.4.6 Confirming an error message

If an error occurs, an error message is shown in the display.



- ▶ To confirm an error message: .

Errors which have occurred and have not yet been rectified are shown by a warning symbol () in the header.

Error messages which have not yet been removed can be viewed in the **Inst' diagnosis** menu, see *Instrument diagnosis*, p. 26.

## E.4.7 Scanning locations with the barcode pen

Locations marked with barcode labels can be scanned using the barcode pen (0554 0461).

- 1 Connect the connector of the barcode pen to the PS2 interface of the measuring instrument.
- 2  → **Memory / Location** → .
- 3 Scan the barcode: Hold the barcode pen over the white surface and then move swiftly over the barcode label.
  - If the scanned barcode is already created as a location in the measuring instrument, this location is activated automatically.
  - If the scanned barcode is not yet created as a location in the instrument, a new location is created.See also *Memory/Location*, on this page.

## E.4.8 Switching the measuring instrument off

 Unsaved readings are lost when the measuring instrument is switched off.

- ▶ .
- Possibly: The pump starts and the measuring cells are rinsed until the shut-off thresholds ( $O_2 > 20\%$ , other parameters  $< 50$  ppm) are reached. Rinsing lasts no more than 3 minutes.
- The measuring instrument switches off.



## E.5 Memory/Location

All readings are allocated to the location that is activated at the time and can be saved in the **Flue gas** menu. Unsaved readings are lost if the measuring instrument is switched off!

Locations can be created, edited and activated. (Measuring) protocols can be printed. The special function **Extras memory** can be used to display the available memory. All protocols can be printed or deleted. The entire memory (locations and protocols) can also be cleared.

### Calling up the function:

 → **Memory / Location** → .

### Creating a new location:

Locations are identified by a unique location name. Each location name can only be allocated once.

- 1 **New location** → .
- 2 Select **Location name** → .
- 3 Enter values → **OK Save input** → .
- 4 Execute steps **2** and **3** for the other criteria accordingly (only testo 330-2, -3 / testo 330-2LL).
- 5 **OK Go to measurement** or **OK TO memory/location** → .

### Ordering a list (testo 330-2, -3):

- 1 **Locations list** → .
- 2 Select the order criterion: ,  (only testo 330-2, -3 / testo 330-2LL) or  (only testo 330-2, -3 / testo 330-2LL).

### Restoring a list (testo 330-2, -3):

- 1 Order the list in the sequence in which the locations were created:  
**Restore list** → .

### Activating a location:

- ▶ Select the location → .
- The location is activated and the **Measurements** menu is opened.

### Printing/displaying protocols:

If automatic furnace data are stored with a measurement protocol the following symbol is displayed next to the protocol name: . The data are printed with the protocol printout.

1 Select the location → .

**Options:**

▶ To print all data of the chosen location: **Print all** → .

▶ To delete all data of the chosen location: **Delete all** → .

2 To print a single data: Select the protocol → .

-or-

2 To display saved readings of a measurement: Select the protocol → .

**Options:**

▶ To print the protocol: .

▶ To delete the protocol: .

**Editing the location:**

1 Select the location → .

**Options:**

▶ To delete the location: .

▶ To change the location: .

**Special function Extras memory**

**Calling up a function:**

▶  → **Memory/Location** → .

- The available memory is displayed.

**Options:**

**Print all data** → .

**Delete all data** → .

**Delete memory** → .

## E.6 Instrument diagnosis

Important operating values and device data are displayed. A gas path check (testo 330-2, -3 / testo 330-2LL) can be carried out. The status of the measuring cells and device errors which have not yet been rectified can be viewed.

### Calling up the function:

▶  → **Inst' diagnosis** → .

-or-

▶ .

### Carrying out a gas path check (testo 330-2, -3 / testo 330-2LL)

1 **Gas path check** → .

2 Place the black sealing cap on the tip of the flue gas probe.

- The pump flow is displayed. If the flow rate is  $\leq 0,02$  l/min, the gas paths are not leaking.

3 End the check: .

### Viewing device errors:

▶ **Error diagnosis** → .



- Unrectified errors are displayed.

▶ View next/previous error: , .

### Viewing sensor diagnosis:

1 **Sensor check** → .

- Possibly: Gas zeroing (30 s).

2 Select measuring cell: , .

- The status of the measuring cell is displayed.

# F. Configuration

This chapter describes the possible steps for adapting the product to the particular measurement task or the requirements of the user.

**!** Familiarity with the contents of the chapter *Operation* (see p. 17) is assumed.

## F.1 Instrument settings

### F.1.1 Display edit

The parameters/units and the display representation (number of readings displayed per display page) can be set.

Available parameters and units:

Display	Parameter	Units
<b>FT</b>	Flue gas temperature	°C, °F
<b>CO2</b>	Carbon dioxide	%
<b>qA</b>	Flue gas loss	%
<b>λ</b>	Air ratio	-
<b>O2</b>	Oxygen	%
<b>CO</b>	Carbon monoxide	ppm, %, mgm <sup>3</sup> , g/GJ, mgKW
<b>uCO</b>	Carbon monoxide undiluted	ppm
<b>η</b>	Efficiency	%
<b>NO</b>	Nitrogen monoxide	ppm, %, mgm <sup>3</sup> , g/GJ, mgKW
<b>NOx</b>	Nitrogen oxide	ppm, %, mgm <sup>3</sup> , g/GJ, mgKW
<b>AT</b>	Ambient temperature	°C, °F
<b>O2 air</b>	Oxygen addition	%
<b>Drght</b>	Flue draught	mbar, hPa, mmWS, inW

Display	Parameter	Units
<b>T1</b>	Temperature 1 (flue gas socket)	°C, °F
<b>T2</b>	Temperature 2 (probe socket)	°C, °F
<b>ΔT</b>	Differential temperature T1 - T2	°C, °F
<b>Itemp</b>	Instrument temperature	°C, °F
<b>DP</b>	Flue gas dew point temperature	°C, °F
<b>ΔP</b>	Differential pressure	mbar, hPa, mmW, inW
<b>Gasfl</b>	Gas flow rate	m <sup>3</sup> /h, l/h
<b>GasP</b>	Gas burner output	kW
<b>OilFI</b>	Oil flow rate	kg/h
<b>Oil p</b>	Oil pressure	bar
<b>OilP</b>	Oil burner output	kW
<b>CO2</b>	Carbon dioxide	%
<b>amCO2</b>	Ambient carbon dioxide	ppm
<b>amCO</b>	Ambient carbon monoxide	ppm
<b>Pabs</b>	Absolute pressure	hPa, mbar
<b>Pump</b>	Pump output	l/m

**Calling up the function:**

▶  → **Inst' settings** →  → **Display edit** → .

**Setting the display representation:**

▶ Select **4 values on disp large** or **8 values on disp small** → .

**Changing parameters and units:**

1 Select the display position.

**Options:**

▶ To insert a line: .

▶ To delete a parameter: .

2  → Select parameter →  → Select unit → .

**Saving settings:**

▶ **OK Save input** → .

## F.1.2 Printer

The headers (lines 1-3) and the footer for the printout can be set. The printer that is used can be activated.

**Calling up the function:**

▶  → **Inst' settings** →  → **Printer** → .

**Setting the printed text:**

1 **Print text** → .

2 Select **Line 1**, **Line 2**, **Line 3** or **Footnote** → .

3 Enter values → **OK Save input** → .

4 Execute steps 2 and 3 for the other lines in the same way.

5 **OK Save input** → .

**Printer selection:**

▶ **Select Printer** →  → Select printer → .

## F.1.3 Alarm limits

A limit value can be set for ambient CO probes, leak detection probes and CO<sub>2</sub> probes. A visual and optical alarm is triggered if a limit value is exceeded.

### Calling up the function:

▶  → **Inst' settings** →  → **Alarm limits** → .

### Setting the alarm thresholds/alarm signal:



#### Optional:

▶ To reset all values to default values: **Default values** → .

1 Select the parameter.

#### Optional:

▶ To reset the alarm threshold of the chosen parameter to the default value:  
.

2  → Set the values → .

3 Repeat steps 1 and 2 for the other parameters/the alarm signal as required.

### Saving settings:



▶ **OK Save input** → .

## F.1.4 Start Keys edit

How the function keys are configured depends on the chosen function. Only the function keys in the start screen (shown when the measuring instrument is switched on) can be assigned any function from the **Measurements** menu.

The function keys are only active if the required probes are connected.

### Calling up the function:

▶  → **Inst' settings** →  → **Start Keys edit** → .

### Assigning a function to the start keys:

1 Select function → Press the function key that is to be assigned the chosen function.

2 Repeat step 1 for the other function keys as required.

### Saving settings:

▶ **OK Save input** → .

## F.1.5 Communication

Select interface IrDa/Bluetooth.

Calling up the function:

▶  → **Inst' settings** →  → **Communication** →

Set IrDa/Bluetooth:

▶ Select **IrDA** oder **Bluetooth** → .

## F.1.6 Date/Time

The date and the time can be set.

Calling up the function:

▶  → **Inst' settings** →  → **Date/Time** →

Setting the date/time:

▶ Select **Time** or **Date** →  → Set the values → .

Saving settings:

▶ **OK Save input** → .

## F.1.7 Language

The menu language can be set.

Calling up the function:

▶  → **Inst' settings** →  → **Language** → .

-or-

▶  → **Geräteinst.** →  → **Sprache** → .

Setting the language:

▶ Select **Deutsch** or **Englisch** → .

-or-

▶ Select **German** or **English** → .

## F.2 Sensor settings

NO<sub>2</sub> addition and shut-off thresholds for protecting the measuring cells can be set. Recalibration can be carried out (a calibration adapter is required: 0554 1205).

### Calling up the function:

▶  → **Sensor settings** → .

### Setting the NO<sub>2</sub> addition:

▶ **NO2 addition** →  → Set the value → .

### O<sub>2</sub> reference:

The O<sub>2</sub> reference value is set to 21.00%. It cannot be changed.

### Setting sensor protection:



Protection limits can be set to protect the measuring cells against overload. The sensor protection is activated if the threshold is exceeded:

- testo 330-1 / testo 330-1 LL: Switch-off
- testo 330-2, -3 / testo 330-2 LL: Dilution, if exceeded again: Switch-off

If the threshold is set to 0ppm, the sensor protection is deactivated.

1 **Sensor protection** → .

2 Select the parameter.

3  → Set the values → .

4 Repeat steps 2 and 3 for the other parameters in the same way.

▶ Saving settings: **OK Save input** → .

### Recalibration:

CO and NO measuring cells can be recalibrated. A calibration adapter (0554 1205) must be connected.

If obviously unrealistic readings are displayed, the measuring cells should be checked and recalibrated as required.

Have the check/recalibration carried out by a Testo qualified service centre.



Dangerous gases

#### Danger of poisoning!

- ▶ Observe safety regulations/accident prevention regulations when handling test gases.
- ▶ Use test gases in well ventilated rooms only.



! Recalibration with low gas concentrations can lead to fluctuations in accuracy in the upper measuring ranges.

- 1 Connect the calibration adapter to the flue gas socket.
- 2 **Recalibration** → .
- Gas zeroing (30 s).
- 3 Select the parameter →  → Enter the test gas concentration (required value).
- 4 Attach the connecting cable of the test gas bottle to the calibration adapter.
- 5 Charge the measuring cell with test gas.
- 6 Start calibration: .
- 7 Accept the actual value as soon as the required value is stable: .

## F.3 Fuels

The fuel can be chosen. The fuel-specific coefficients can be set.

### Calling up the function:

- ▶  → **Fuels** → .

### Activating fuel:

- ▶ Select the fuel .

### Setting coefficients:

- 1 .

#### Optional:

- ▶ To reset all coefficients to default values: **Default values** → .

- 2 Select the coefficients.

#### Optional:

- ▶ To reset the chosen coefficients to default values: .

- 3  → Set the values → .

- 4 OK Save input .

# G. Measuring

*This chapter describes the measuring tasks that can be carried out with the product.*

**!** Familiarity with the contents of the chapter *Operation* (see p. 17) is assumed.

## G.1 Preparing measurements

### G.1.1 Zeroing phases

#### Measuring the combustion air temperature

If no combustion air temperature probe is connected, the temperature measured by the thermocouple of the flue gas probe during the zeroing phase is used as the combustion air temperature. All dependent parameters are calculated by this value. This method of measuring combustion air temperature is sufficient for systems dependent on ambient air. However, the flue gas probe must be near the intake duct of the burner during the zeroing phase.

If a combustion air temperature probe is connected, the combustion air temperature is measured continuously via this probe.

#### Gas zeroing

The first time a gas measuring function is called up after the instrument has been switched on, the measuring cells are zeroed.

**!** testo 330-1, -3 / testo 330-1 LL: The flue gas probe must be in the open air during the zeroing phase!

The “Gas zeroing, probe in flue (0440 3331)” option is available as an option for the testo 330-3.

testo 330-2 / testo 330-2 LL: The flue gas probe can be in the flue pipe even during the zeroing phase, if a separate AT probe is attached.

#### Draught/pressure zeroing

The pressure sensors are zeroed when a pressure measuring function is called up.

**!** testo 330-1, -2 / testo 330-1 LL: The flue gas probe must be in the open air during the zeroing phase/the instrument must not be pressurised during zeroing! The “Draught zeroing, probe in flue (0440 3330)” option is available as an option for the testo 330-2.

testo 330-3 / testo 330-2 LL: The flue gas probe can be in the flue pipe even during the zeroing phase, if a separate AT probe is attached.

## G.1.2 Using the modular flue gas probe

### Checking the thermocouple



The thermocouple of the flue gas probe must not lie against the probe cage.

- ▶ Check before use. Bend the thermocouple back if necessary.

### Aligning the flue gas probe



The flue gas must be able to flow freely past the thermocouple.

- ▶ Align the probe by turning it as required.

The tip of the probe must be in the centre of the flue gas flow.

- ▶ Align the flue gas probe so that the tip is in the centre of the flow (area of the highest flue gas temperature).

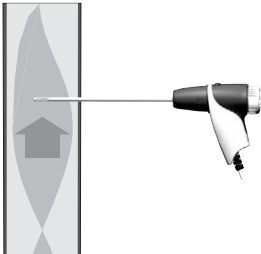

## G.1.3 Configuring the reading display

Only those parameters and units which are activated in the reading display appear in the reading display, the saved measurement protocols and the protocol printouts.

- ▶ Before beginning measurements, configure the reading display so that the required parameters and units are activated, see *Display edit*, p. 28.

## G.1.4 Set memory/location

Before carrying out measurements, the measurement location and the fuel must be correctly selected siehe *Memory/Location*, p. 24 and *Fuels*, p.33.

## G.2 Measurements

### G.2.1 Flue gas

The **Flue gas** menu is the main measuring menu in which - in addition to the readings measured with this function - the readings of all measurements carried out are displayed (if selected in the **Display edit** menu). All readings can also be saved or printed out from this menu.

The **Flue gas** menu can always be selected, regardless of which probes are connected.

! The measurement values from the functions **Draught, O2 air, Differential temp., Differential press** and **Smoke No./HCT** are transferred to the the central measurement menu **Flue gas** and must therefore be carried out before the flue gas measurement.

#### Calling up the function:

▶  → **Measurements** → **OK** → **Flue gas** → **OK**.

- Possibly: Gas zeroing (30 s).

#### If no fuel has yet been selected:

▶ Select the fuel → **OK**.

#### Measuring:

1 Start measuring: **Start**.

#### Reading CO undiluted:

If a separate measurement of CO undiluted has not yet been carried out, this value is calculated using the readings of the flue gas probe and is updated continuously.

If CO undiluted has already been measured separately, the value obtained is adopted.

- The readings are displayed.

2 Stop measuring: **Stop**.

#### Options:

▶ To print readings: **Print**.

▶ To save readings: **Save**.

- The readings from the flue gas measurement, as well as any readings taken over into the menu **Flue Gas** from other measurement functions are stored and/or printed in a measurement protocol (automatic furnace data are not printed).

## G.2.2 Draught

A flue gas probe must be connected.

- ! The pressure socket of the instrument must be free (i.e. unpressurised, not closed).
- ! Do not measure for longer than 5 min, as the drift of the pressure sensor means that the readings could be outside the tolerance limits.

### Calling up the function:

▶  → **Measurements** → **OK** → **Draught** → **OK**.

### Measuring:

- 1 Start measuring: **Start**.
  - Draught zeroing (5 s).
- 2 Position the flue gas probe in the hot spot (area of the highest flue gas temperature). The display showing the maximum measured flue gas temperature (FT) helps when positioning the probe.
  - The reading is displayed.
- 3 Stop measuring **Stop**.
  - The reading is recorded.

### Optional:

- ▶ To print the reading: **Print**.
- 4 Copy the reading to the **Flue gas** menu: **OK**.
    - The **Measurements** menu is opened.

## G.2.3 Fine pressure probe (accessory)

The following measurements can be carried out using the fine pressure probe:

- E-draught
- E-Delta-P
- See also instruction manual *Fine pressure probe*.

## G.2.4 BlmSchV (testo 330-3 / testo 330-2LL)

Two different prescribed measurement sequences can be performed in the **BlmSchV** menu: They are the BlmSchV measurement sequence and the qA mean value measurement sequence.

CO measurement can then be switched off.

In the qA mean value sequence, 3 successive flue gas loss measurements are taken and the mean value is calculated from them.

In the BlmSchV sequence, a draught measurement is performed first, then a flue gas measurement. Regardless of the device settings, 8 readings are shown per display page in a fixed order.

The readings are recorded in the **BlmSchV** menu and are not copied to the **Flue gas** menu! A flue gas probe and a combustion air temperature probe must be connected.

### Calling up the function:

▶  → **Measurements** →  → **BlmSchV** → .

- Possibly: Gas zeroing (30 s).

#### If no fuel has yet been selected:

▶ Select the fuel → .

### Activating/deactivating the CO measurement and Hot spot search:

1 Select **CO measurement ON** or **CO measurement OFF**.

2 Position the flue gas probe in the hot spot (area of the highest flue gas temperature). The display showing the current and maximum measured flue gas temperature (FT) helps when positioning the probe.

#### Optional:

▶ To reset the temperature value **max FT**: .

### qA mean value measurement sequence:

3 Start the measurement sequence: .

- The **qA** menu is opened.

4 Start qA value measuring: .

- The three qA values are measured one after the other (25s respectively).

- The mean value of the three qA measurements is shown.

5 Copy the readings to the **BlmSchV** menu: .

- The **BlmSchV** menu is opened.

**Options:**

- ▶ To print readings: .
- ▶ To save readings: .
- ▶ Start flue gas measurement (BlmSchV measurement sequence): continue with the *BlmSchV sequence, Step 4*, on this page.

**BlmSchV measurement sequence:**

- 3 Start the measurement sequence: .
  - The **BlmSchV** menu is opened.
- 4 Start flue gas measurement: .
- The readings are displayed.
- 5 Stop flue gas measurement: .
- The **Draught** menu is opened.
- 6 Start draught measurement: .
- Draught zeroing (5 s).
- The reading is displayed.
- 7 Stop measurement .
- The reading is recorded.
- 8 Copy the reading to the **BlmSchV** menu: .
- The reading is copied to the **BlmSchV** menu.
- The **BlmSchV** menu is opened.

**Options:**

- ▶ To print readings: .
- ▶ To save readings: .

## G.2.5 CO undiluted

A multi-hole probe (0554 5762) must be connected.

### Calling up the function:

▶  → **Measurements** → **OK** → **CO undiluted** → **OK**.

### Measuring:

- 1 Start measurement: **Start**.
  - Possibly: Gas zeroing (30 s).
  - The reading is displayed.
- 2 Stop measurement: **Stop**.
  - The reading is recorded.

### Options:

- ▶ To print the reading: **Print**.
- 3 Copy the reading to the **Flue gas** menu: **OK**.
    - The **Measurements** menu is opened.

## G.2.6 Smoke No./HCT

### Calling up the function:

▶  → **Measurements** → **OK** → **Smoke No./HCT** → **OK**.

### Recording smoke tester no./smoke numbers/oil derivative with the smoke pump and manual input:

The function is only available if the chosen fuel is an oil.

- 1 **Sm. tester no.** → **Change** → Enter pump number → **OK**.
- 2 **Smoke# 1** → **Change** → Enter the value → **OK**.
- 3 Repeat step 2 for the other smoke numbers and oil derivative as required.

### Recording smoke tester no./smoke numbers/oil derivative with the smoke tester testo 308 and wireless transfer:

- testo 308 must be in data transfer mode (  lights up).

- 1 Press function key **t308**.
  - The values recorded by the smoke tester are transferred.
- 2 Once all values have been transferred, select function key **OK**.

### Entering the heat carrier temperature:

▶ **Heat carrier** → **Change** → Enter the value → **OK**.



### Copy the values to the Flue gas menu:

! The smoke number/HCT-values are not displayed in the menu **Flue gas**. They can, however, be printed or stored in a measurement protocol, together with the measurement values of a flue gas measurement. In the menu **Memory / Location**, the smoke count/WTT values can be displayed in the measurement program, printed or transferred to a Pocket PC/PC.

- ▶ **OK Copy readings** → **OK**.
- The **Measurements** menu is opened.

## G.2.7 Differential pressure

The gas pressure set (0554 1203) must be connected.



Dangerous mixture of gases

### Danger of explosion!

- ▶ Make sure there are no leaks between the sampling point and the measuring instrument.
- ▶ Do not smoke or use naked flames during measurement.

! Do not measure for longer than 5 min, as the drift of the pressure sensor means that the readings could be outside the tolerance limits.

### Calling up the function:

 → **Measurements** → **OK** → **Differential press.** → **OK**.

### Measuring:

- 1 Start measurement: **Start**.
  - Pressure zeroing (3 s).
  - ▶ Pressurise the connecting lines.
  - The reading is displayed.
- 2 Stop measurement: **Stop**.
  - The reading is recorded.

### Options:

- ▶ To print the reading: **Print**.
- 3 Copy the reading to the **Flue gas** menu: **OK**.
    - The **Measurements** menu is opened.

## G.2.8 Differential temperature

The difference temperature set (0554 1204) must be connected.

### Calling up the function:

▶  → **Measurements** → **OK** → **Differential temp.** → **OK**.

### Measuring:

1 Start measurement: **Start**.

- The readings and the calculated temperature difference (T1 - T2) are displayed.

2 Stop measurement: **Stop**.

- The readings are recorded.

### Options:

▶ To print readings: **Print**.

3 Copy the readings to the **Flue gas** menu: **OK**.

- The **Measurements** menu is opened.

## G.2.9 O<sub>2</sub> air

An O<sub>2</sub> dual wall clearance probe (0632 1260) must be connected.

### Calling up the function:

▶  → **Measurements** → **OK** → **O<sub>2</sub> air** → **OK**.

### Measuring:

1 Start measurement: **Start**.

- Possibly: Gas zeroing (30 s).

- The reading is displayed.

2 Stop measurement: **Stop**.

- The reading is recorded.

### Optional:

▶ To print the reading: **Print**.

3 Copy the reading to the **Flue gas** menu: **OK**.

- The **Measurements** menu is opened.

## G.2.10 Gas flow rate

The **Gas flow rate** function is only available if the activated fuel is a gas.

### Calling up the function:

▶  → **Measurements** → **OK** → **Gas flow rate** → **OK**.

### Measuring:

- 1 Enter the duration of measurement: **Sample time** → **Change** → Enter the value (**18, 36 or 180s**) → **OK**.
- 2 Start measuring: **Start**. Observe the counter reading of the gas meter.
  - The remaining measurement period is displayed.
  - When the measurement period has lapsed, a long beep is emitted. The last 5s are indicated by a short beep.
- 3 Enter the flow rate: **Flow rate** → Enter the value → **OK**.
  - The calculated gas burner output is displayed.
- 4 Copy the values to the **Flue gas** menu: **OK Copy readings** → **OK**.
  - The **Measurements** menu is opened.

## G.2.11 Oil flow rate

The **Oil flow rate** function is only available if the activated fuel is an oil.

### Calling up the function:

▶  → **Measurements** → **OK** → **Oil flow rate** → **OK**.

### Measuring:

- 1 Enter the flow rate: **Flow rate** → **Change** → Enter the value → **OK**.
- 2 Enter the oil pressure: **Oil pressure** → **Change** → Enter the value → **OK**.
  - The calculated oil burner output is displayed.
- 3 Copy the values to the **Flue gas** menu: **OK Copy readings** → **OK**.
  - The **Measurements** menu is opened.

## G.2.12 Leak detection

Gas is detected during leak detection; the gases are not measured.

A gas leak probe (0632 3330) must be connected.

**!** Please refer to the documentation enclosed with the gas leak probe.

### Calling up the function:

▶  → **Measurements** → **OK** → **Leak detection** → **OK**.

### Measuring:

- ▶ Carry out the setting for the gas to be detected according to the instructions found in the documentation for the gas leak probe.
- The gas concentration is shown in a graph (trend display).
- An alarm message is given if the alarm threshold is exceeded.
  - ▶ Set alarm threshold: see *Alarm limits*, p. 30.

## G.2.13 Ambient CO

An ambient CO probe (recommended) or a flue gas probe must be connected.

**!** Cigarette smoke influences the measurement by more than 50 ppm. The breath of a smoker influences the measurement by about 5 ppm.

When using an ambient CO probe, note that:

The direction of flow of the gas has an effect on the accuracy of measurement.

Frontal flow onto the probe leads to higher readings. The best measurement results are achieved when the probe is moved gently backwards and forwards.

When using the ambient CO probe 0632 1247, note that:

The sealing cap must remain closed during the zeroing phase.

Only open the sealing cap for the period of measurement.

When using ambient CO probe 0632 3331 or a flue gas probe, note that:

The probe must be located in fresh air (CO free) during the zeroing phase.

### Calling up the function:

▶  → **Measurements** → **OK** → **Ambient CO** → **OK**.

### Measuring:

1 Start measurement: **Start**.

- If measuring using a flue gas probe or the ambient CO probe 0632 1247 possibly: gas zeroing (30 s).
- Measuring starts and the reading is displayed as a number and graphically.

- An alarm message is given if the alarm threshold is exceeded.
  - ▶ Set alarm threshold: see *Alarm limits*, p. 30.

2 Stop measurement: **Stop**.

- The reading is recorded.

#### Options:

- ▶ To print the reading: **Print**.

3 Copy the reading to the **Flue gas** menu: **OK**.

- The **Measurements** menu is opened.

## G.2.14 Ambient CO<sub>2</sub>

An ambient CO<sub>2</sub> probe (0632 1240) must be connected.

! In order to obtain correct readings, it is imperative to enter the prevailing absolute pressure.

#### Calling up the function:

▶  → **Measurements** → **OK** → **Ambient CO<sub>2</sub>** → **OK**.

#### Enter absolute pressure directly:

▶ **Absolute** → **OK** → Set the value → **OK**.

-or-

#### Enter absolute pressure via barometric pressure and height:

1 **From height** → **OK** → **Barometric** → **Change** → Set the value → **OK**.

2 **Altitude** → **Change** → Set the value → **OK**.

3 **OK Save input** → **OK**.

#### Measuring:

1 Start measuring: **Start**.

- Possibly: warming-up phase (up to 30s).
- The reading is displayed.
- An alarm message is given if the alarm threshold is exceeded.
  - ▶ Set alarm threshold: see *Alarm limits*, p. 30.

2 Stop measuring: **Stop**.

- The reading is recorded.

#### Optional:

To print the reading: **Print**.

- 3 Copy the reading to the **Flue gas** menu: **OK** .
- The **Measurements** menu is opened.

## G.2.15 Burner control

With the help of the readout adapter for automatic furnaces (0554 1206), status data and malfunction reports can be read out from compatible automatic furnaces, see also documentation for readout adapter. The range of data which can be read out is dependent on the automatic furnace type.

### Calling up the function:

- 1 Connect readout adapter to the instrument (PS2 interface) and the automatic furnace (use adapter ring if necessary).

- 2  → **Measurements** → **OK** → **Burner Control**.

#### Option:













- ▶ Display type and version of the adapter: **Adapt.**

- 3 **OK** .

- The data are read from the automatic furnace. An update of the data takes place every 30s at the latest, this is dependent on the automatic furnace.

### Reading out current status data:

The current data are displayed when a connection to the automatic furnace exists. The following data are displayed with the help of symbols:

Component	Status ON	Status OFF	Component	Status ON	Status OFF
Air controller			Flame		Symbol not displayed
Motor			Ignition		
Valve1			Oil prewarmer		
Valve 2					

### Printing data:

- ▶ **Print** .

### Display identification data:

- ▶ **Info** → **OK** .

### Display failure statistic:

- ▶ **Failure statistic** → **OK** .

### Reading out failure store:

Automatic furnaces are equipped with circular buffer memories, i.e. failure reports are overwritten when the failure store is full.. The last failure occurring is at position 1 in the failure list.

▶ **Failure**.

#### Option:

▶ Scroll through failure list: ▲, ▼.

### Taking readings over into the menu **Flue Gas**:

! The readings are not presented in the display, in the menu **Flue Gas** they can be stored with the readings from a flue gas measurement, stored in a measurement protocol or transferred to a pocket PC/PC.

For taking data over into the menu **Flue Gas** the function fields **Info** and **Failure statistic** must not be active (grey background).

▶ **OK**.

- The Menu Measurements is opened.

# H. Transferring data

## H.1 Protocol printer

If data are to be transferred to a Testo protocol printer via the infrared interface, the printer that is to be used must be activated, see *Printer*, p. 29.

Data are printed out via the function key . The function is only available if a printout is possible.

## H.2 PC/Pocket PC

Data can be transferred to a PC via USB, IrDA oder Bluetooth®.

Data can be transferred to a Pocket PC via infrared or Bluetooth®.

You must also refer to the documentation that comes with the software.



# I. Care and maintenance

*This chapter describes the steps and action required in order to keep the product functioning properly.*

See also *Regular care*, p. 20.

## I.1 Cleaning the measuring instrument

- ▶ If the housing of the instrument is dirty, clean it with a damp cloth. Do not use any aggressive cleaning agents or solvents! Weak household cleaning agents and soap water may be used.

## I.2 Replacing measuring cells

A slot bridge (0192 1552) must be inserted in slots which do not have a measuring cell. Used measuring cells must be disposed of as special waste!

The instrument must be switched off.

- 1 Place the measuring instrument on its front.
- 2 Remove the service cover: Take hold of it at the markings (arrows) using the index finger and thumb, press slightly, fold up and remove.
- 3 Pull hose connections from the fault measuring cell/bridge.
- 4 Remove the faulty measuring cell/bridge from the slot.

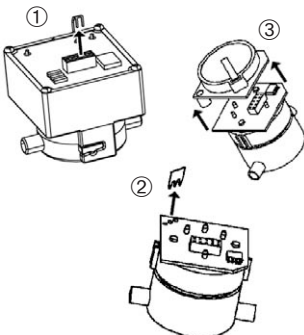

**!** Remove short-circuit brackets/additional boards from the new measuring cells just prior to insertion. Do not leave measuring cells for longer than 15 minutes without short-circuit brackets/additional boards.

- ▶ CO measuring cell for testo 330-1 / testo 330-1 LL: Remove the shorting jumper ①.
- ▶ CO measuring cell for testo 330-2, -3 / testo 330-2LL: Remove the shorting jumper ②.
- ▶ NO/NO<sub>low</sub> measuring cell: Remove the auxiliary circuit board ③.

- 5 Insert a new measuring cell/bridge in the slot.
- 6 Attach hose connections to the measuring cell/bridge.
- 7 Attach the service cover and engage it in place.

**!** After replacing an O<sub>2</sub> measuring cell, wait 60 minutes before using the instrument again.

The corresponding parameter and unit have to be activated when measuring cells are upgraded. See *Display edit*, p.28.

## I.3 Recalibrating measuring cells

See *Sensor settings*, p. 32.

## I.4 Replacing additional filter

The additional filter provides added protection should problems occur with the particle filter in the flue gas probe. The additional filter is very rarely contaminated if the measuring instrument is used normally.

- ▶ Check the additional filter (visually) for contamination from time to time and replace it if necessary.



- 1 Place the measuring instrument on its front.
- 2 Remove the service cover: Take hold of it at the markings (arrows) using the index finger and thumb, press slightly, fold up and remove.
- 3 Release the additional filter from the hose connections.
- 4 Fit a new filter (0133 0010) on the hose connections.
- 5 Attach the service cover and engage it in place.

## I.5 Cleaning the modular flue gas probe

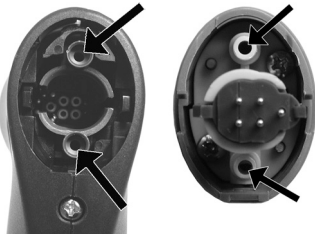

**!** Disconnect the flue gas probe from the measuring instrument prior to cleaning.

- 1 Release the probe catch by pressing the key on the probe handle and remove the probe module.
- 2 Blow compressed air through the flue ducts of the probe module and probe handle (see illustration). Do not use a brush!
- 3 Fit a new probe module on the handle and engage it in place.

## I.6 Changing the thermocouple

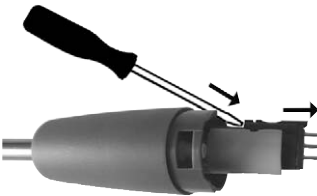

- 1 Release the probe catch by pressing the key on the probe handle and remove the probe module.
- 2 Remove the thermocouple plug-in head from the socket using a screwdriver and pull the thermocouple out of the probe shaft.
- 3 Keep inserting new thermocouple in the probe shaft until the connection head clicks into place.
- 4 Fit a new probe module on the handle and engage it in place.

# J. Questions and Answers

*This chapter gives answers to frequently asked questions.*

Question	Possible causes	Remedy
Measuring instrument keeps switching off by itself <b>or</b> Measuring instrument will not switch on.	Battery spent	▶ Charge the battery or connect the mains unit (see <i>Operation</i> , p. 17).
Display of the battery capacity appears faulty	Battery was often not fully discharged/charged.	▶ Discharge battery fully (until instrument switches off by itself) and then charge fully.
Failure report: <b>Pump flow rate to high</b>	Gas output closed.	▶ Ensure that gas output is free

If we were unable to answer your question, please contact your distributor or Testo Customer Service. For contact data, see back of this document or web page [www.testo.com/service-contact](http://www.testo.com/service-contact)

## K. Technical data

### K.1 Standards and inspections

- As declared in the certificate of conformity, this product fulfils the guidelines of 2004/108/EEC.
- This product is TÜV approved to 1. BImSchV.
- This product is TÜV tested in accordance with EN50379 part 2, exception: The parameter CO in the instrument versions testo 330-1/testo 330-1 LL are TÜV tested in accordance with EN50379 part 3.

## K.2 Measuring ranges and accuracies

Parameter	Measuring range	Accuracy	Resolution	t90 <sup>1</sup>
O <sub>2</sub>	0...21 Vol.%	±0.2 Vol.%	0.1 Vol.%	< 20s
CO (testo 330-1 / testo 330-1LL)	0...4,000 ppm (H <sub>2</sub> level <10%)	±20 ppm ±5 % of reading ±10 % of reading	at 0...400 ppm at 400.1...1,000 ppm at 1,000.1...4,000 ppm	1 ppm < 40s
CO, H <sub>2</sub> -comp. (testo 330-2, -3 / testo 330-2LL) <sup>2</sup>	0...8,000 ppm	±10 ppm or ±10 % of reading <sup>3</sup> ±20 ppm or ±5 % of reading <sup>3</sup> ±10 % of reading	at 0...200 ppm at 201...2,000 ppm at 2,001...8,000 ppm	1 ppm < 40s
amCO <sub>2</sub> via flue gas probe	0...2,000 ppm	±10 ppm ±10 % of reading	at 0...100 ppm at 101...2,000 ppm	1 ppm < 35s
amCO <sub>2</sub> via 0632 3331	0...500ppm	±5ppm ±5% of reading	at 0...100ppm <sup>4</sup> at 101...500ppm <sup>4</sup>	1ppm -
NO (NOlow meas. cell)	0...300 ppm	±2 ppm ±5 % of reading	at 0.0...40.0 ppm at 40.1...300.0 ppm	0.1 ppm < 30s
NO (NO meas. cell)	0...3,000 ppm	±5ppm ±5% of reading ±10% of reading	at 0...100ppm at 101...2,000ppm at 2001...3,000ppm	1ppm < 30s
Draught <sup>5</sup>	-9.99...40 hPa	±0.02 hPa or ±5% of reading <sup>3</sup> ±0.03 hPa ±1.5 % of reading	at -0.50...0.60 hPa at 0.61...3.00 hPa at 3.01...40.00 hPa	0.01 hPa -
ΔP	0...200 hPa	±0.5 hPa ±1 % of reading ±1.5 % of reading	at 0.0...50.0 hPa at 50.1...100.0 hPa at 100.1...200.0 hPa	0.1 hPa -

<sup>1</sup> Response time 90%; recommended minimum measurement time to ensure correct measurement values: 3 min;  
<sup>2</sup> above sensor protection limit: Resolution 500ppm (up to max. 3000ppm);<sup>3</sup> the larger value applies;  
<sup>4</sup> at 10...30°C, outside this range additionally ±0.2% of reading/°C ; <sup>5</sup> with fine draught measurement option:  
 Measuring range 0...100.0Pa, Resolution 0.1Pa

Parameter	Measuring range	Accuracy	Resolution	t90 <sup>1</sup>	
Temperature	-40...1,200 °C	±0.5 °C ±0.5 % of reading	at 0.0...100.0 °C in rem. range	0.1 °C at -40...999.9 °C 1 °C at 1,000°C...1,600 °C	Depending on probe
Efficiency	0...120 %	-		0.1 %	-
Flue gas loss	-20.0...99.9 %	-		0.1 %	-
amCO <sub>2</sub> via 0632 1240	0...10,000ppm	±50ppm+2% of reading ±100ppm+3% of reading	at 0...5,000ppm at 5001...10,000ppm	1ppm	-

<sup>1</sup> Response time 90%; recommended minimum measurement time to ensure correct measurement values: 3 min



## K.3 Other device data

Characteristic	Values
Operating temperature range	-5...45 °C
Storage/transport temperature	-20...50 °C
Power supply	Battery block: 3.7V/2.4Ah Mains unit: 6.3 V/1.2 A
Dimensions (L x W x H)	270 x 90 x 65 mm
Weight	600 g (excluding battery)
Memory	testo 330-1, -2 / testo 330-1 LL: 200 locations testo 330-3 / testo 330-2 LL: 400 locations
Display	Monochrome, 4 grey levels, 160 x 240 pixels
Battery storage temperature:	±0...35°C
Battery life	>6h (pump on, display lighting off, 20 °C ambient temperature)
Battery charge time	approx. 5-6h
Warranty	testo 330-1, -2, -3: Measuring instrument: 24 months Measuring cells: 24 months  Flue gas probe: 24 months Thermocouple: 12 months Battery: 12 months  testo 330-1 LL, -2 LL: Measuring instrument: 48 Monate LL-Measuring cells O <sub>2</sub> , CO: 48 Monate, Other Measuring cells: 24 Monate Flue gas probe: 48 Monate Thermocouple: 12 Monate Battery: 12 Monate
Option Bluetooth®	Typ-designation: BlueNiceCom IV Bluetooth Qualified Product Notice: BNC4_HW2x_SW2xx Bluetooth listing identifier: B013784 Bluetooth listing company: 10274
Option Bluetooth®	Range <10m
Option Bluetooth® Certification	<b>EU countries</b> Belgium (BE), Bulgaria (BG), Denmark (DK), Germany (DE), Estonia (EE), Finland (FI), France (FR), Greece (GR), Ireland (IE), Italy (IT), Latvia (LV), Lithuania (LT), Luxembourg (LU), Malta (MT), Netherlands (NL), Austria (AT), Poland (PL), Portugal (PT), Romania (RO), Sweden (SE), Slovakia (SK), Slovenia (SI), Spain (ES), Czech Republic (CZ), Hungary (HU), United Kingdom (GB) and Republic of Cyprus (CY). <b>Other EFTA Countries</b> Iceland, Liechtenstein, Norway and Switzerland <b>Non-European countries</b> Colombia, Turkey <b>Information from FCC (Federal Communications Commission)</b> Contains FCC ID: P1403B - Paragraph 15.19 Labeling requirements - This instrument fulfils 15 of the FCC guideline - Commissioning is subject to the following two conditions: 1. This instrument may not cause any dangerous interference 2. This instrument must accept any interference received, including interference which may cause undesired operation. <b>Changes</b> The FCC requires that the user is informed that all changes and modifications to the instrument which are not expressly approved by Testo AG, can void the right of the user to operate the instrument.

## K.4 EC declaration of conformity



### EG-Konformitätserklärung

### EC declaration of conformity

Für die nachfolgend bezeichneten Produkte:

We confirm that the following products:

**Testo 330-1 LL / -2 LL**  
(*bluetooth*)

Best. Nr.: / Order No.: 0632 3304; 0632 03305

wird bestätigt, daß sie den wesentlichen Schutzanforderungen entsprechen, die in der Richtlinie des Rates zur Angleichung der Rechtsvorschriften der Mitgliedstaaten über die **elektromagnetische Verträglichkeit** (2004/108/EG) festgelegt sind.

corresponds with the main protection requirements which are fixed in the EEC "Council Directive 2004/108/EC on the approximation of the laws of the member states relating to electromagnetic compatibility".  
The declaration applies to all samples of the above mentioned product.

Zur Beurteilung der Erzeugnisse hinsichtlich elektromagnetischer Verträglichkeit im Kleingewerbebereich wurden folgende Normen herangezogen:

*For assessment of the product following standards have been called upon:*

**Störaussendung / Pertubing radiation:**  
**Störfestigkeit: / Pertubing resistance:**

DIN EN 50270:2000-01 Typ 1  
DIN EN 50270:2000-01 Typ 1

**R&TTE Richtlinie:**

EN 300 328 V1.7.1 (2006-10)  
EN 301 489-1 V1.6.1 (2005-09)  
EN 301 489-17 V1.6.1 (2002-08)  
EN 60950-1 (2006-11)

**Sicherheits-Richtlinie:**

Diese Erklärung wird für:

*This declaration is given in responsibility for:*

Testo AG  
Postfach / P.O. Box 1140  
79849 Lenzkirch / Germany  
www.testo.com

abgegeben durch / by:

Herr Walleser Mr. Walleser  
(Name) (name)

Vorstand Managing Director  
(Stellung im Betrieb des Herstellers) (Position in the company of the manufacturer)

Lenzkirch, 10.12.2008  
(Ort, Datum / place, date)

  
(Rechtsgültige Unterschrift / Legally valid signature)



Der Hersteller betreibt ein zertifiziertes Qualitätssicherungssystem nach DIN ISO 9001

*The manufacturer operates a certified quality assurance system according to DIN ISO 9001*

## K.5 Principles of calculation

### K.5.1 Fuel parameters

Fuel	A2 <sup>1</sup>	B <sup>1</sup>	CO <sub>2</sub> max	O <sub>2</sub> reference
Natural gas	0,660	0,009	11,8 Vol.%	3 Vol.%
Light oil	0,680	0,007	15,4 Vol.%	3 Vol.%
LPG	0,630	0,008	13,7 Vol.%	3 Vol.%
Wood	0,765	0,000	20,3 Vol.%	13 Vol.%
Pellets	0,765	0,000	20,3 Vol.%	13 Vol.%
Briquette	0,833	0,000	18,9 Vol.%	8 Vol.%
Lignite	0,955	0,000	19,8 Vol.%	8 Vol.%
Anthracite	0,758	0,000	20,5 Vol.%	8 Vol.%
Coke oven gas	0,600	0,011	10,3 Vol.%	3 Vol.%
Town gas	0,630	0,011	13,6 Vol.%	3 Vol.%
Test gas	0,0000	0,000	0,00 Vol.%	0 Vol.%

<sup>1</sup> Fuel-specific factor

<sup>2</sup> Default setting

### K.5.2 Calculation formulae

Carbon dioxide: 
$$CO_2 = \frac{CO_{2max} \times (21\% - O_2)}{21\%}$$

CO<sub>2</sub>max: Maximum carbon dioxide specific to fuel  
 21%: Oxygen level of air  
 O<sub>2</sub>: Measured oxygen level in %

Flue gas loss: 
$$qA = \left( (FT - AT) \times \left( \frac{A2}{21\% - O_2} + B \right) \right) - Kk$$

FT: Flue gas temperature  
 AT: Ambient temperature  
 A2/B: Fuel-specific parameters  
 21%: Oxygen level of air  
 O<sub>2</sub>: Measured oxygen level in %  
 Kk: Calculated value allowing for regained condensate heat if dewpoint level is not reached (for condensing furnaces).

Efficiency: 
$$\eta = 100 - qA$$

qA: Calculated flue gas loss



Air ratio:	$\lambda = \frac{CO2max}{CO2}$	<p>CO2max: Maximum carbon dioxide specific to fuel</p> <p>CO2: Calculated carbon dioxide value</p>
Nitrogen oxide:	$NOx = NO + (NO2add \times NO)$	<p>NO: Measured nitrogen monoxide value</p> <p>NO2add: Nitrogen dioxide addition factor</p>
Carbon monoxide undiluted:	$uCO = CO \times \lambda$	<p>CO: Measured carbon monoxide value</p> <p><math>\lambda</math>: calculated air ratio</p>
Flue gas dew point temperature:	$FTP = \frac{\ln\left(\frac{FH20 \times PAbs}{610.78}\right) \times 234.175}{\ln\left(\frac{FH20 \times PAbs}{610.78}\right) - 17.08085}$	<p>FH20: Flue gas specific water vapour level in Vol. %</p> <p>PAbs: Absolute pressure in mbar/hPa</p>
Conversion of ppm in mg/m <sup>3</sup> :		
Carbon monoxide:	$CO \text{ [mg/m}^3\text{]} = \frac{21\% - O2ref}{21\% - O2} \times CO \text{ [ppm]} \times 1.25$	<p>21%: Oxygen level of air</p> <p>O2: Measured oxygen level in %</p> <p>O2ref: Fuel-specific oxygen reference value in %</p>
Nitrogen oxide:	$NOx \text{ [mg/m}^3\text{]} = \frac{21\% - O2ref}{21\% - O2} \times NOx \text{ [ppm]} \times 2.05$	<p>21%: Oxygen level of air</p> <p>O2: Measured oxygen level in %</p> <p>O2ref: Fuel-specific oxygen reference value in %</p>



# L. Accessories / Spare parts





Designation	Part no.
<b>Modular flue gas probes</b>	
Modular flue gas probe 180 mm, 500 °C, thermocouple 0.5 mm, probe shaft diameter: 8 mm	0600 9760
Modular flue gas probe 300 mm, 500 °C, thermocouple 0.5 mm, probe shaft diameter: 8 mm	0600 9761
Modular flue gas probe 180 mm, 500 °C, thermocouple 0.5 mm, probe shaft diameter: 6 mm	0600 9762
Modular flue gas probe 300 mm, 500 °C, thermocouple 0.5 mm, probe shaft diameter: 6 mm	0600 9763
<b>Probe modules / Accessories for modular flue gas probes</b>	
Probe shaft module 180 mm, 500 °C, thermocouple 0.5 mm, probe shaft diameter: 8 mm	0554 9760
Probe shaft module 300 mm, 500 °C, thermocouple 0.5 mm, probe shaft diameter: 8 mm	0554 9761
Probe shaft module 180 mm, 500 °C, thermocouple 0.5 mm, probe shaft diameter: 6 mm	0554 9762
Probe shaft module 300 mm, 500 °C, thermocouple 0.5 mm, probe shaft diameter: 6 mm	0554 9763
Probe shaft module 300 mm, 1,000 °C, thermocouple 1.0 mm, probe shaft diameter: 6 mm	0554 8764
Probe shaft module 700 mm, 1,000 °C, thermocouple 1.0 mm, probe shaft diameter: 6 mm	0554 8765
Spare thermocouple for module 0554 9760, 0554 9762	0430 9760
Spare thermocouple for module 0554 9761, 0554 9763	0430 9761
Spare thermocouple for module 0554 8764	0430 8764
Spare thermocouple for module 0554 8765	0430 8765
Cone, 8mm, steel	0554 3330
Cone, 6mm, steel	0554 3329
Flexible probe shaft module	0554 9764
Extension for modular flue gas probe, 2.80 m	0554 1201
Particle filter, 10 pcs.	0554 3385
<b>Temperature probes</b>	
Combustion air temperature probe, 300 mm	0600 9791
Combustion air temperature probe, 190 mm	0600 9787
Combustion air temperature probe, 60 mm	0600 9797
Pipe wrap probe	0600 4593
Surface probe	0600 0194
<b>Other probes</b>	
O <sub>2</sub> dual wall clearance probe	0632 1260
Gas leak probe	0632 3330
Ambient CO probe	0632 3331
Ambient CO <sub>2</sub> probe (without connecting cable)	0632 1240
Connecting cable for Ambient CO <sub>2</sub> probe, 1,5m	0430 0143
Gas pressure set: Draught path adapter, silicone hose 4 mm/6 mm, reducing cones	0554 1203
Difference temperature set, 2 pipe contact probes, adapter	0554 1204
Readout adapter for automatic furnaces	0554 1206

Designation	Part no.
<b>Retrofitted measuring cells</b>	
NOlow retrofitting	0554 3931
NO retrofitting	0554 3922
<b>Upgrade to testo 330 LL</b>	
Retrofitting of LL measurement cells, only by Testo customer service	on request
<b>Spare measuring cells</b>	
O <sub>2</sub> measuring cell for testo 330-1, -2, -3	0390 0092
CO measuring cell for testo 330-1 (H <sub>2</sub> -compensated)	0390 0095
CO measuring cell for testo 330-2, -3 (H <sub>2</sub> -compensated)	0390 0109
O <sub>2</sub> measurement cell for testo 330-1 LL, -2LL	0390 0061
CO measurement cell for testo 330-1 LL	0390 0110
CO measurement cell for testo 330-2LL (H <sub>2</sub> -compensated)	0390 0090
NOlow measuring cell	0390 0094
NO measuring cell	0390 0074
<b>Cases</b>	
Service case high	0516 3331
Service case flat	0516 3330
<b>Printers</b>	
Desktop printer	0554 0547
IrDA fast printer incl. rechargeable battery and charging adapter	0554 0548
<b>Other accessories</b>	
Barcode pen	0554 0461
Mains unit	0554 1086
Charger with spare battery	0554 1087
Spare battery (rechargeable)	0515 0100
Device/PC connecting cable	0449 0047
Easyheat (PC configuration software)	0554 3332
Full version Easyheat and Easyheat mobile (PC configuration software and software for Windows Handheld PCs)	0554 1210
Upgrade Easyheat mobile (Software für Windows Handheld PCs)	0554 1211
Additional filter	0133 0010
Flue draught set	0554 3150
Fine pressure probe	0638 0330
Capillary hose set	0554 1215

# Functional overview

The table gives an overview of the most important functions configured on the individual instruments. Detailed information about the individual functions can be found on the pages indicated.

testo 330 -1 -2 -3 -1LL -2LL	Task	Call/function	see page
		 → Measurements → <input type="button" value="OK"/> →	
x x x	Carry out flue gas measurement	Flue gas → <input type="button" value="OK"/>	p. 36
x x x	Carry out draught measurement	Draught → <input type="button" value="OK"/>	p. 37
	x Carry out flue gas measurement sequence BlmSchV or qA mean value	BlmSchV → <input type="button" value="OK"/>	p. 38
x x x	Carry out CO undiluted measurement	CO undiluted → <input type="button" value="OK"/>	p. 40
x x x	Enter smoke no./heat carrier temperature	Smoke No. / HCT → <input type="button" value="OK"/>	p. 40
x x x	Carry out differential pressure measurement	Differential press. → <input type="button" value="OK"/>	p. 41
x x x	Carry out differential temperature measurement	Differential temp. → <input type="button" value="OK"/>	p. 42
x x x	Carry out O2 air supply measurement	O2 air → <input type="button" value="OK"/>	p. 42
x x x	Determine gas flow rate	Gas flow rate → <input type="button" value="OK"/>	p. 43
x x x	Determine oil flow rate	Oil flow rate → <input type="button" value="OK"/>	p. 43
x x x	Carry out gas leak search	Leak detection → <input type="button" value="OK"/>	p. 44
x x x	Carry out ambient CO measurement	Ambient CO → <input type="button" value="OK"/>	p. 44
x x x	Carry out ambient CO2 measurement	Ambient CO2 → <input type="button" value="OK"/>	p. 45
x x x	Read automatic furnace	Burner control → <input type="button" value="OK"/>	p. 46
		 → Memory/Location → <input type="button" value="OK"/> →	
x x x	Create new location	New location → <input type="button" value="OK"/>	p. 24
x	Order location list by location name	Locations list → <input type="button" value="Locat"/>	p. 24
	x x Order location list by name or address	Locations list → <input type="button" value="Name"/> or <input type="button" value="Addr"/>	p. 24
x x x	Order location list by sequence of creation	Restore list → <input type="button" value="OK"/>	p. 24
x x x	Display measurements of one location	Select location → <input type="button" value="Data"/>	p. 24
x x x	Print all measurements of a location	Select location → <input type="button" value="Data"/> → <input type="button" value="Print all"/> → <input type="button" value="OK"/>	p. 24
x x x	Delete all measurements of a location	Select location → <input type="button" value="Data"/> → <input type="button" value="Delete all"/> → <input type="button" value="OK"/>	p. 24
x x x	Show readings of selected measurements of a location	Select location → <input type="button" value="Data"/> → Select protocol → <input type="button" value="Value"/>	p. 24
x x x	Print selected measurements of a location	Select location → <input type="button" value="Data"/> → Select protocol → <input type="button" value="Print"/>	p. 24
		 → Memory/Location → <input type="button" value="Extra"/> →	
x x x	Print all measurements in the memory	Print all data → <input type="button" value="OK"/>	p. 24
x x x	Delete all measurements in the memory	Delete all data → <input type="button" value="OK"/>	p. 24
x x x	Delete entire memory (measurements and locations)	Delete memory → <input type="button" value="OK"/>	p. 24

testo 330 -1 -2 -3 -1LL -2LL	Task	Call / function	see page
		 → Instr' settings → <input type="button" value="OK"/> →	
x x x	Set reading display	Display edit → <input type="button" value="OK"/>	p. 28
x x x	Select printer, set printing text	Printer → <input type="button" value="OK"/>	p. 29
x x x	Set alarm thresholds	Alarm limits → <input type="button" value="OK"/>	p. 30
x x x	Set start screen function key assignment	Start Keys edit → <input type="button" value="OK"/>	p. 30
x x x	Set date/time	Date/Time → <input type="button" value="OK"/>	p. 31
x x x	Set language	Language → <input type="button" value="OK"/>	p. 31
		 → Sensor settings → <input type="button" value="OK"/> →	
x x x	Enter NO <sub>2</sub> addition	NO <sub>2</sub> addition → <input type="button" value="ändern"/>	p. 32
x x x	Set sensor protection	Sensor protection → <input type="button" value="OK"/>	p. 32
x x x	Perform recalibration	Recalibration → <input type="button" value="OK"/>	p. 32
		 → Fuels →	
x x x	Activate fuel	Select fuel → <input type="button" value="OK"/>	p. 33
x x x	Change fuel coefficients	Select fuel → <input type="button" value="Coeff"/>	p. 33
		 -or-  → Inst' diagnosis →	
x x	Perform gas path check	Gas path check → <input type="button" value="OK"/>	p. 26
x x x	View device errors	Error diagnosis → <input type="button" value="OK"/>	p. 26
x x x	View sensor diagnosis	Sensor check → <input type="button" value="OK"/>	p. 26



**205 Westwood Ave**  
**Long Branch, NJ 07740**  
**1-877-742-TEST (8378)**  
**Fax: (732) 222-7088**  
**salesteam@Equipment.NET**





