

Operating Manual

E20/20 TDR & Avionics TDR

Step Time Domain Reflectometer



E20/20 Step TDRs and Avionics TDR all models



Testing Made Simple!

AEA Technology, Inc.



Proprietary Information

Reproduction, dissemination, or use of information contained herein for purposes other than operation and/or maintenance is prohibited without the written authorization from AEA Technology, Inc.

© 2012-2016 by AEA Technology, Inc. All rights reserved. This document and all software or firmware designed by AEA Technology, Inc. is copyrighted and may not be copied or altered in any way without the written consent from AEA Technology, Inc.

E20/20 TDR™, Avionics TDR™, ETDR PC Vision™ and the AEA Logos are trademarks of AEA Technology, Inc.

Cable data available in this manual, TDR firmware, or ETDR PC Vision software, TDR training and training aids reflects information published by the respective manufacturers. This information is believed to be accurate at the time of publication, but can not be guaranteed. Please consult specific cable manufacturer's website or catalogs and specification sheets for up-to-date information.

Acknowledgements:

Windows XP, Windows 7, Windows Vista, Excel, Word, and Power Point are registered trademarks of Microsoft Corp.

WD-40 is a registered trademark of WD-40 Company

409 cleaner is a registered trademark of Clorox Corp.

FTDI Drivers are products of Future Technology Devices International, Ltd.

Popper Clips (Telco Clips) are products of J. S. Popper Company

Alpha, Andrews, Belden, BerkTek, Commscope, Superior-Essex, Times Fiber, and other cable manufacturer's names appearing in this manual or TDR firmware and software are trademarks and property of their respective owners. AEA Technology, Inc. is not sponsored by, and is not affiliated with any of these companies.

Table of Contents

Warnings and Precautions	V
Section 1 Getting Started	1
Operating Guidance Documents	1
Keypad and LCD Display	2
Connector Configurations	3
Measurement Screen.....	4
Keypad	4
ON/OFF Key	4
Soft Reset	4
Hard Power Down	5
Arrow, Escape & Enter Keys	5
Menu Keys	6
Help	6
Meter	6
Trace	7
Memory	7
Cable	8
Function Keys	8
Range	8
Zoom	9
Z Scale	9
Cursors 1 & 2	9
Tone	10
Alpha-numeric Keys & Backspace key	10
Section 2 Setup and Basic Operation	11
General	11
Step TDR Operation	11
Impedance affects	12
Velocity factor (VF)	13
Loop resistance and dribble up	13
Menu Navigation Guide	13
Setup Wizard.....	14
Manual Setups.....	15
Help.....	15
Meter.....	15
Battery Menu.....	16
Charger Status.....	17
Date/Time Menu.....	17
Trace.....	18
Z Scale	18
Trace Range	18
Start Distance.....	18
MicroFault.....	18
Test Lead Null	19
Noise filter	20

Section 2 – Setup and Basic Operation (continued)	
Cables.....	20
Pick/Edit List	20
Manual Entry.....	20
Velocity Search.....	21
Sample a Cable.....	21
Distance Units.....	22
Selected Cable.....	22
Measurement Screen and Controls (Function Keys).....	22
Range.....	22
Z Scale.....	22
Cable Type	23
CRSR 1 & CRSR 2.....	23
Tone.....	24
Section 3 Test and Measurement Setups	25
Introduction	25
Coaxial Test Setups	25
Coax Cable Parameters	26
Impedance	26
Velocity Factor	28
Loop Resistance	30
Coax Cable Connections	31
Example Coax Cable Traces	34
Twisted Pair Test Setups	37
Twisted Pair Cable Parameters	38
Impedance	38
Velocity Factor.....	40
Loop Resistance	41
Twisted Pair Cable Connections and Pair Selection	43
Example Twisted Pair Cable Traces	47
Testing Single Wires in a Harness	52
Testing Power Cables or Other Cables with Large Gauge Conductors	55
Other E20/20 Step TDR Applications	56
Advance Testing Features	56
Z Scale Function	56
Zoom Function	57
Start Distance	60
Test Lead Null	61
Micro Fault Locating	64
Noise Filter	65
Velocity Search and Sample a Cable.....	67
Velocity Search	67
Sample a Cable	69

Section 4 – E20/20 TDR Trace Memory and Cable Lists	73
Introduction	73
Saving and Recalling Traces.....	73
General	73
Saving traces	74
Recall traces	75
Deleting Traces	76
Restore prior settings	78
Editing the TDR's Cable List	78
General	78
Edit Cable List Instructions	79
Section 5 – ETDR PC Vision™ Software	83
Operating Systems	83
Installation	83
Run ETDR PC Vision	84
Working <u>with</u> the E20/20 TDR connected	84
Get Trace Tab	85
Connection error correction	86
Check List to Establish Communications	86
Stored Traced Tab	88
Open Trace Plot	89
Chart Information	90
Plot controls	90
TDR Setups Tab	94
Cables Tab	95
Working <u>without</u> the E20/20 TDR connected	96
FTDI Driver Installation	97
Windows 7	97
Preventing Auto Increment of the Serial Port	98
Introduction	98
Overview	99
Choosing a Different COM Port	100
Default Locations for data files supplied with ETDR PC Vision	101
ETDR PC Vision Software Updates	101
Software Technical Support	102
Section 6 – Warranty, Troubleshooting Guide, Maintenance, and Service Returns	103
Limited warranty	103
Operating Precautions	103
External DC Power	104
Batteries	104
Cleaning	104
TDR Troubleshooting Guide.....	105
ETDR PC Vision Troubleshooting Guide.....	106
Power/Battery Troubleshooting Guide.....	106

Instrument Return Instructions	107
Contact Us	107
Return Material Authorization (RMA) Number	107

Appendices

Specifications	A-1
Twisted Pair Wiring and Connection Guide	B-1
Accessories List	C-1
TDR LCD and ETDR PC Vision Trace Resolution Tables	D-1
Extreme Cold Weather Operations.....	E-1



WARNING

Explosive atmosphere testing was accomplished on our TDRs to meet MIL-SPEC 810G, Method 511.5, Procedure 1. The E20/20 TDR and Avionics TDR are free of any internal ignition sources. However, the following ignition sources are a potential spark hazard and appropriate precautions apply:

DC Charging Port and A/C Adapter

Charging the E20/20 TDR or Avionics TDR or operating while using the A/C or D/C adapters can create external sparks. Connecting or use of these power sources in an explosive atmosphere is dangerous and should never be attempted. Always charge the TDR away from any explosive atmosphere. Use ONLY internal battery power if the presence of explosive fumes is a potential hazard.

Coax and RJ-45 Test Ports

The presence of any voltage, from an applied source or static build-up on cables, can cause an ignition spark when the cable is connected to the TDR. Caution should be taken to ensure cables are free of any voltages or static charge prior to connecting the TDR in a potentially explosive atmosphere.

Operating Precautions

1. The TDRs are designed for recharging NiMH or NiCd AA cells only. Do NOT install and attempt to charge Lion cells as overheating or fire may result. The resulting damage is not covered under warranty.
2. Alkaline cells may be used safely in the TDR, but when installed go to the Battery Menu and change the Battery Type to ALKALINE or NONE to turn off the charger. Attempting to charge alkaline or carbon cells may result in the cells outgassing. The resulting damage is not covered under warranty.
3. The TDR has input voltage protection and a high voltage detection system which will warn if connected to more than 50VDC or 1 VAC pk-to-pk. Use caution with the cable if this detection warning appears in the display as the actual voltage will be unknown.
4. The TDR is splash resistant and designed to work for relatively long periods in rain depending on intensity. It is not designed to be immersed in water.

Section 1 Getting Started

The E20/20 Step TDRs and Avionics TDR have three operational guidance documents:

Quick Start Guide – Laminated tri-fold guide designed to be carried in the belt case and provide quick reminders on how to navigate the menus and operate functions on the TDR.

Basic Guide – The printed booklet with basic information for setting up and using the TDR. This booklet contains more information and step-by-step guidance than the Quick Start Guide, but is not as complete and detailed as the Operating Manual.

Operating Manual – This book is available on the CD included with all TDRs or at www.aeatechnology.com. It contains complete operating instructions, testing examples, full specifications, troubleshooting guides, warranty information, and cleaning instructions. It's a PDF document formatted for local printing.

Warning and Operating Precautions

If you have not already done so, please read the Explosive Atmosphere Warning and other operating precautions on page v right after the Table of Contents.

Both the E20/20 TDRs and Avionics TDR operate essentially the same. Differences between these TDRs will be pointed out in all the documents where appropriate. Most differences are identified in the Appendices.

Basic and Advanced Training for the E20/20 TDR's and Avionics TDR is available in Microsoft Power Point® Format on the CD included with the TDR and our web site at www.aeatechnology.com. Customers are also welcome to call or email us at techsupport@aeatechnology.com to get assistance with getting started, ask operational questions, or questions about test results. Group training via web conference is also available upon request.

If you have any questions concerning the operation, application, training or environment use please contact AEA Technology, Inc. at 1-800-258-7805 or +1-760-931-8979 or at www.aeatechnology.com.

Keypad and Display

Top Connectors - See Figure 1-2 for all available connector combinations

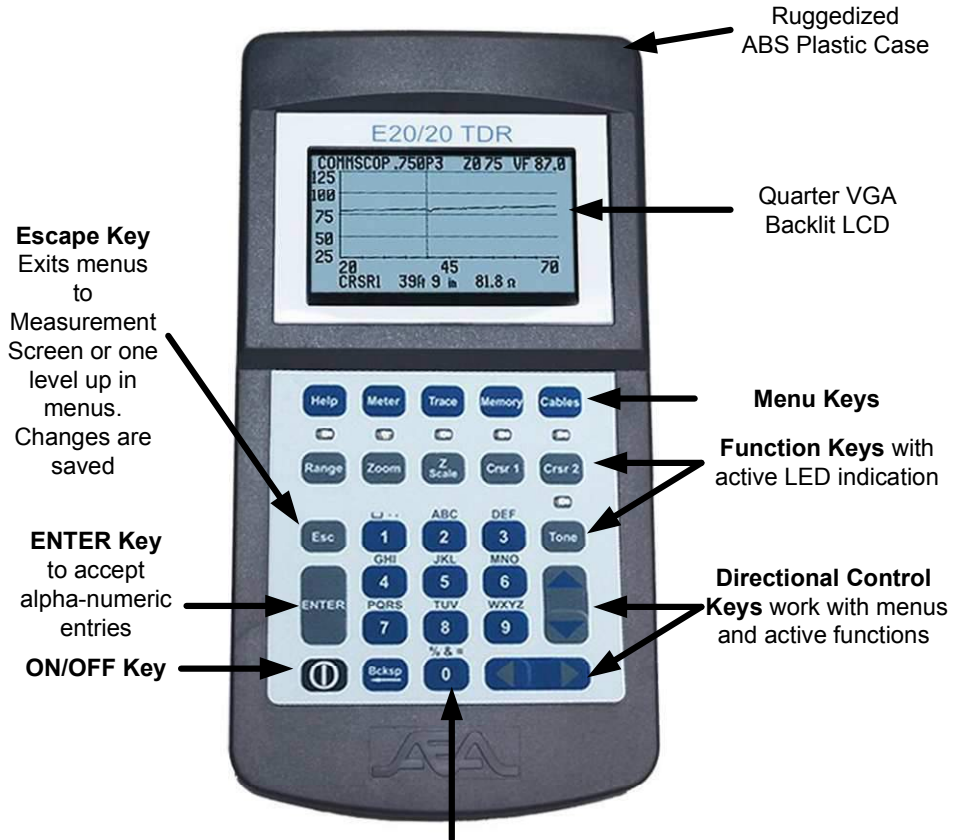

Escape Key
Exits menus to Measurement Screen or one level up in menus. Changes are saved

ENTER Key
to accept alpha-numeric entries

ON/OFF Key

Ruggedized ABS Plastic Case

Quarter VGA Backlit LCD

Menu Keys

Function Keys with active LED indication

Directional Control Keys work with menus and active functions

Alpha-numeric Keypad and Backspace Key

Figure 1-1

Physical layout is the same for the Avionics TDR

Top End Connector Configurations (figure 1-2)

E20/20N TDR

Part Number 6021-5000 – Broadcast Cable List and N-to-BNC adapter included.



E20/20F Network (F and RJ-45 Connectors)

Part Number 6021-5041 – CATV Cable List

Part Number 6021-5042 – Telco Cable List



E20/20B Network (BNC and RJ-45 Connectors)

Part Number 6021-5053 – VDV/RF Cable List

Avionics TDR

Part Number 6021-5054 – TDR with Avionics Cable List

Part Number 6021-5154 – TDR Kit with Avionics Cable List



Figure 1-2

Measurement Screen (figure 1-3)

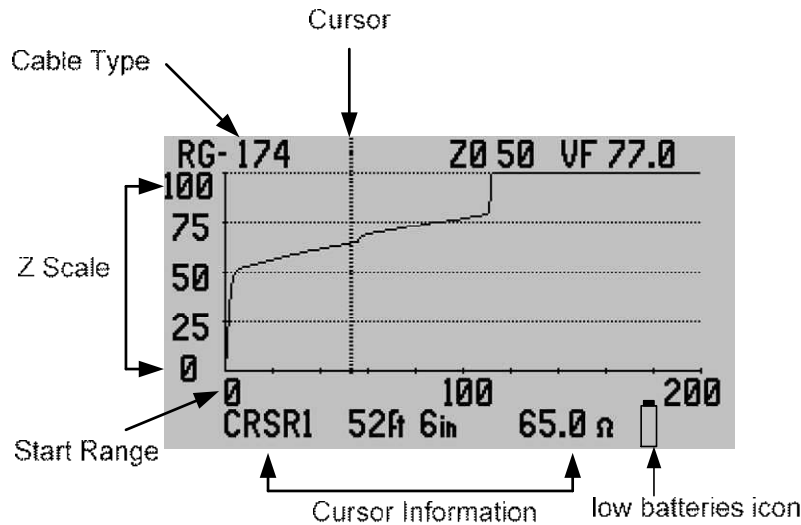

Figure 1-3

Keypad



ON/OFF key – Press once to turn the TDR on. This will restore all the previous settings from the last time it was turned off. Press once to turn the TDR off.

Soft Reset

- Step 1. With the TDR off, press and hold the ENTER key.
- Step 2. Press the ON/OFF key for 1 second and release.
- Step 3. After 2 seconds release the ENTER key.

Note: If the TDR's menu cursors stop responding, the measurement screen does not show correctly, or any other failures to perform correctly occur, the TDR's firmware may need to be reset. The Soft Reset (similar to rebooting a PC) function performs several housekeeping functions and restores the TDR to factory default values. It will NOT erase saved traces or changes to the Cable List. The low battery icon's operation is not affected. It will still appear and blink to warn about a low battery condition. See figure 1-3.

Hard Power Down

If the firmware hangs up during operation the TDR may not power down with a 1 second press of the ON/KEY. In this case press and hold the key for at least 10 seconds. When released, the TDR should power down. If a Hard Power Down is required, perform a Soft Reset on the first power on to ensure proper operation.

Arrow, Escape and Enter Keys

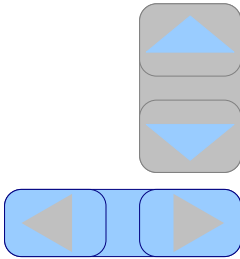

Arrow Keys – In the menus the up/down arrow keys control the cursor arrow and the left/right arrow keys control the selected feature's options or ranges. In the Measurement Screen the up/down arrow keys activate for the Z Scale and Tone function keys. The left/right arrow keys control the Range, Zoom, Cursor 1, and Cursor 2 when those functions are active. The ◀▶ ▲▼ Indicators in the TDR's menus and user literature indicate when to use the appropriate arrow keys.

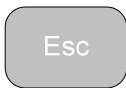

Escape Key – Unless specified otherwise in the TDR's directions, this key is used to exit the menus and either return to the Measurement Screen or back up one menu level. Any changes made in the menus will be saved and applied to the measurements or instrument operation when Esc is pressed.



ENTER key – This key is used to accept alpha-numeric changes in the menus. Example: Save function requests a name for the saved trace. After the name is complete using the alpha-numeric keypad, press ENTER to store the trace.

The ENTER key is also used to perform a Soft Reset of the instrument's firmware:

- Step 1. With the TDR off, press and hold the ENTER key.
- Step 2. Press the ON/OFF key for 1 second and release.
- Step 3. After 2 seconds release the ENTER key.

Menu Keys

General – Menus are designed to make TDR setups and cable selection easy as possible. When making selections in different menus pressing the next desired menu key will jump directly from the current menu to the new menu. It is not necessary to escape back to the Measurement Screen after work in each menu to save the changes and select another menu. When selections are done in one or more menus press the “Esc” key to save the changes and exit to the Measurement Screen.



Help Key has two functions: 1. If no keypad functions are active (all LED's unlit) and the TDR is not in a menu, the Help key will open its own menu shown in Figure 1-4.

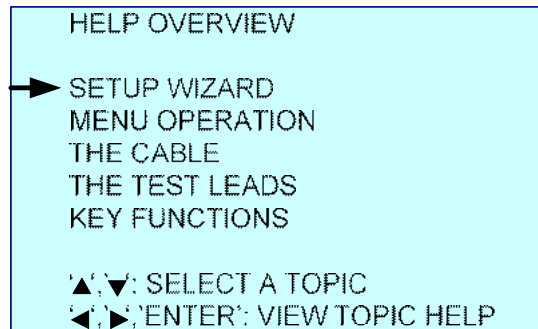

Figure 1-4

2. If a function key is active or any menu is open pressing the Help key will provide context sensitive help about the menu feature pointed at by the menu's cursor, sub-menu, or feature being used.



Meter Key opens a menu for making changes in the instrument's settings. The Meter's menu is shown in Figure 1-5.

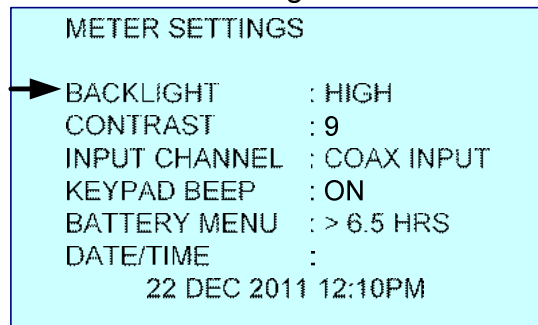

Figure 1-5

NOTE: The E20/20N TDR model has only one input port so no INPUT CHANNEL selection appears on that TDR's Meter menu.

Both the BATTERY MENU and DATE/TIME are sub-menus selected by pressing the right arrow key when the cursor is next to that item. The BATTERY MENU permits setting BATTERY SAVER ON/OFF, BATTERY TYPE, and BATTERY MA-HR. The DATE/TIME menu is for setting the current date and time. See Section 2 in this manual for full details on both sub-menus.

Trace

Trace Key opens a menu for viewing and making changes in the display plot settings, turning on MICRO FAULT detection, eliminating the test leads distance (CABLE NULL), and activating a noise filter. The Trace key's menu is shown in Figure 1-6.

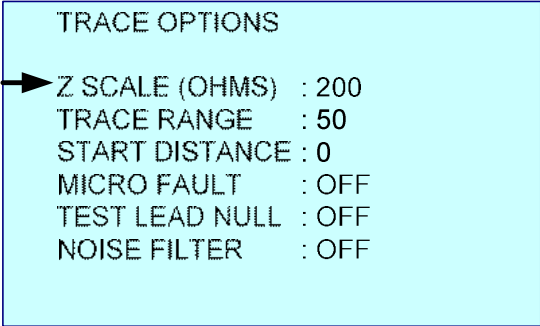

Figure 1-6

Memory

Memory key opens a menu for saving and recalling traces. Saving a trace opens a sub-menu for entering the trace name and automatically saves the date/time with the trace data. Recall opens a list of saved test results. Recalling a trace resets the instrument to the recalled trace's settings. This makes all stored traces a stored instrument set up as well. After recalling one or more traces, selecting PRIOR SETTINGS will restore the TDR to original settings before the recalls. The Memory key's menu is shown in Figure 1-7.

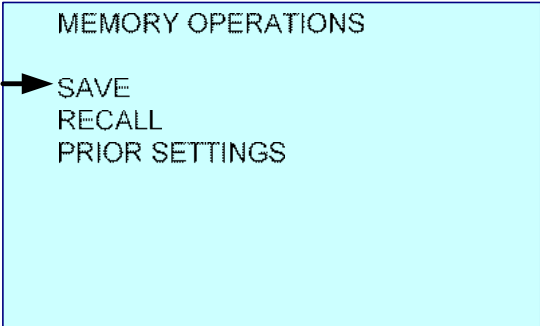

Figure 1-7

Cables

Cables key opens a menu for selecting cable types from a list, editing the list, manually creating a new cable, searching a displayed cable trace for correct velocity, sampling a cable to find its velocity, or changing distance unit between feet or meters. The Cables key's menu is shown in Figure 1-8.

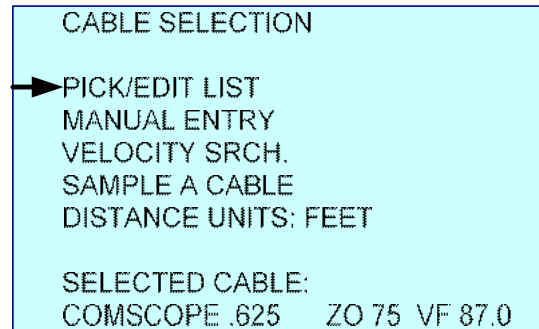

Figure 1-8

Function Keys

General - All the function keys activate and de-active with one press. When active the green LED will light. Some function keys can not be operating simultaneously and will automatically de-activate other function keys when selected.

Range

Range Key – When active, this key uses the ◀▶ keys to control the display ranges. Available ranges are:

Feet	Meters
10	2
20	5
50	10
100	20
200	50
500	100
1,000	200
2,000	500
5,000	1,000
10,000	2,000
20,000	5,000

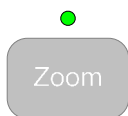

Zoom Key – When active, this key will zoom on Cursor 1 or Cursor 2. If both cursors are on-screen, Zoom will center on the last Cursor key pressed (the active Cursor). When Zoom is active use the ◀▶ keys to control the zoom span. Pressing the ◀ key will reduce the range either side of the cursor until minimum range is reached, pressing the ▶ key will expand the range either side of the cursor until original range setting is reached. To disable the Zoom function, press the Zoom key again. The LED will extinguish and the Measurement Screen will return to the full range originally selected.

NOTE: Zoom function is not available when viewing saved traces

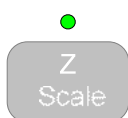

Z Scale Key – When active, this key permits control of the Z (impedance) scale on the left side of the plot. Use the ▲▼ keys to increase or decrease the impedance scale as required. When the impedance is reduced, the TDR will keep the selected cable's impedance (Z_0) centered in the display. Example: For a 75 Ohm coax cable if the impedance is reduced to 20 Ohms the display scale will read 65 Ohms to 85 Ohms.

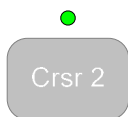
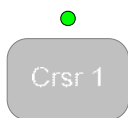

Cursor 1 & Cursor 2 Keys – These keys control the use of the Measurement Screen cursors, one or both at the same time as follows:

Cursor 1 only – Single cursor in the display and a single CRSR1 data line below the plot.

Cursor 2 only – Single cursor in the display and a single CRSR 2 data line below the plot.

Cursor 1 & 2 Dual cursors in the display and two data lines below the plot. Top data line will indicate the last cursor key pressed (active cursor), display that cursor's data, and is under control of the ◀▶ keys. The second data line (CRSRΔ) will be the difference in distance and impedance from the opposite cursor. Both LED's will be lit. To change cursor control press the cursor key desired to be active.

NOTE: When the differential reading from the active cursor is from the left to the right the differential readings will be positive. When the differential reading from the active cursor is right to left the differential range readings will be negative. The Z reading will rely purely on the positive or negative slope of the trace.

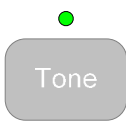

Tone Key – This key activates tones for either coax or twisted pair cables based on INPUT CHANNEL selection in the METER menu. Use standard twisted pair or coaxial cable inductive amplifiers (probes) to detect the tones on the cable.

NOTE: Toning works ONLY when operating on batteries. When the AC adapter is connected some AC is induced with the tones and tones are weakened making them unusable.

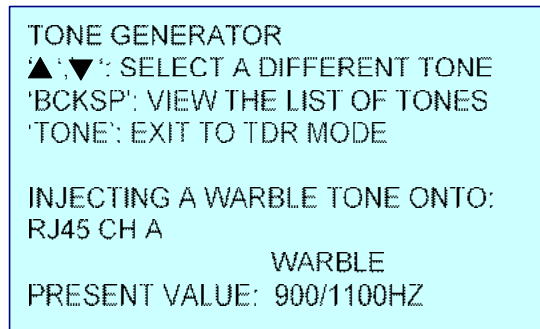

Figure 1-9

Alpha-Numeric Keypad and Backspace Key

General – The alpha-numeric keypad shown in figure 1-10 is for entering values and names. The keys work similar to cell phone pads. Repeated pressing of the same key will cycle from the number to the next alphabetic character. First character above the “1” key is the “space.” The “Bcksp” key (Backspace) will delete the last character entered or character just left of the name entry cursor. Refer to specific menu screen directions for using arrow keys to delete entire entries.



Figure 1-10

Section 2 Setup and Basic Operation

General Information

The following pages provide some basic information concerning cable construction and how a step TDR works. This information is designed to help users set up their TDRs and better understand what a step TDR can show about a particular cable type. The information in Section 2 is for basic operation. Full cable parameters, testing explanations, test and measurement setups, and example traces are covered in Section 3.

Step TDR Operation

TDR's are divided into two basic types: Pulse and Step. A pulse TDR sends out just one pulse at a time and waits until no more reflection can be received from that pulse to send another pulse. This requires adjusting the pulse width and/or gain control on those TDR's to clearly see longer cables and faults further away.

Step TDR's, like the E20/20 TDR and Avionics TDR, transmit continuous wave sweeps on the cable and interpret the reflections to provide more detailed information on the condition of the cable. A Step TDR can not only provide accurate distance to the end of the cable or faults. It can also provide the cable's impedance over length, loop resistance and more detailed reflective information to determine fault type and amplitude.

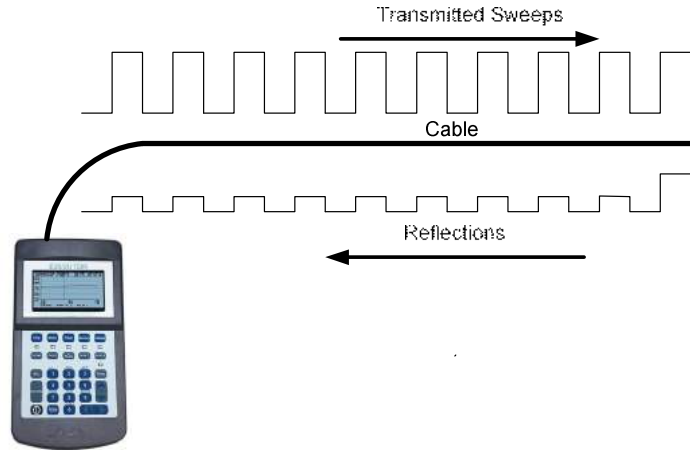

Figure 2-1

Figure 2-1 is a representation of the sweep sent by a Step TDR. The wave is uniform at any range setting and the TDR calibrates to the range selected by the user and the cable's velocity factor used. The result is accurate measurements both in distance and fault amplitude. In a Step TDR, the same 10 Ohm fault will show up as 10 Ohms, no matter what distance it is detected.

Impedance Effects

The impedance measured along the length of a good cable is known as the characteristic impedance (Z_0) and is designed in at the time of manufacture. When measuring with a TDR, the readings displayed are the actual impedance (Z) at each data point along the cable. When a cable is good, you will see impedance readings that are near or equal to Z_0 . When a fault occurs the impedance deviates from Z_0 . Figures 2-2 and 2-3 show the effect of an open or short on the cable's impedance. A Step TDR's trace will react per the display on the right. The reading will change from the horizontal normal impedance reading to either the maximum Ohms for an open or down to 0 Ohms for a short.



Figure 2-2



Figure 2-3

Velocity Factor

A cable's velocity factor (VF) is also designed in at the time of manufacture. VF is expressed as a fraction of the speed of light in a vacuum [c]. A VF of 0.677c indicates that a transmitted wave travels along that cable at 67.7% the speed of light in a vacuum.

TDR's measure the delay time of the reflected signals. The time is divided in two because it is always a round trip, then multiplied by the cable's VF in feet or meters per second to obtain the distance to a particular reflection.

$$\frac{\text{Time}}{2} \times \text{Velocity} = \text{Distance}$$

Loop Resistance and dribble up

Along with measuring the impedance of a cable, a Step TDR also measures a cable's loop resistance. The result is a slight upward slope over distance of the cable as the loop resistance is added to the impedance reading. This phenomenon is referred to as "Dribble Up."

More detailed information about impedance, velocity factor and loop resistance are contained in Section 3 in this manual, AEA Technology's TDR application notes found on the enclosed CD, and at www.aeatechnology.com.

Menu Navigation

When working in the menus here are some basic navigation rules:

- ▼ ▲ Use the up/down arrow keys to move the menu cursor [→] to the desired feature/function.
- ◀ ▶ Use the right arrow key to enter a feature or function and make selections. Many features have a hidden horizontal menu of options. Use the left/right arrows to reveal and select the option desired.

 Esc

Use the Escape key to

1. Save changes and exit the menu to the Measurement Screen.
2. Exit back up one menu level
3. Exit a completed step in Setup Wizard and go on to the next step
4. Exit Cable Table without changing selection
5. Exit Sample Cable or VF Search without saving changes

 ENTER

Use the ENTER key where indicated to make a value or name change (entry is made from the alpha-numeric pad). This will set the new value or name and exit back to the menu item or features list.

Setup Wizard

 Help

Setup Wizard is located in the TDR'S's menu. It's a step-by-step guided setup procedure for preparing the TDR'S for measuring any cable type. The guided process includes:

- Selecting a cable type from a pre-stored list in the TDR or manually entering data
- Set the Z Scale
- Choose units of measurement – feet or meters
- Set the display range
- Set the start distance from the end of the TDR
- Select the input channel – Coax or RJ-45 channel A, B, C, or D (pair selection)
- Test Lead Null. This removes the test lead's length from the measurement

Press the “Esc” key after each selection to move to the next screen and to return to the Measurement Screen after Test Lead Null.

NOTE: Test Lead Null can be a handy way to remove the test lead from measurements, but a word of caution about this feature. If you have test lead Null ON for a 6 ft (2m) test lead for example and you do NOT use that test lead when connecting a cable to the TDR, you will be blind about the cable attached directly to the TDR for 6ft (2m) and any measurements will be off by that distance. Test Lead Null ON is indicated by “(NULL)” in the Measurement Screen

 Trace

or can easily be checked in the menu and turned OFF when not required.

Manual Setups

Help

In addition to the Setup Wizard, the Help key has Help text on the following subjects: Menu Operation, The Cable, The Test Leads and Key Functions. To enter any of these subjects be sure no Function Key is active (no LEDs lit) and no menu open. Then press the Help key, select the subject using the cursor and press the ► key to read the information.

The Help key also provides context sensitive help for:

1. The menu item pointed to by the menu cursor.
2. sub-menus selected
3. when in selected operations like “Sample a Cable”
4. Any active action key – as denoted by the keypad LED.

Press the Help key whenever assistance or more detailed information is required with making selections or using the action keys.

Meter

Use this menu to select the backlight intensity, contrast level, turn on/off keypad beep, or to make settings in the BATTERY MENU or DATE/TIME menu.

BACKLIGHT

The Backlight feature has four settings: OFF, LOW, MID, and HIGH. Use the ◀▶ keys to adjust the backlight intensity or turn the backlight off. When on, the backlight will reduce operating battery hours by 6-10% depending on intensity setting.

CONTRAST

The Contrast will need adjustment depending on temperature of the LCD. Its temperature is affected by the environment, direct sunlight, TDR's operating temperature which will climb with operation time. Use the ◀▶ keys to change the contrast as required. Range is 1-15. Lower numbers will give a clearer display when LCD is warmer and higher numbers a clearer display when LCD is cold. See Appendix E for Cold Weather Operation.

KEYPAD BEEP

The Keypad Beep feature provides an audio feedback that a key was pressed. Use the ◀▶ keys to turn the beep on or off as desired.

BATTERY MENU

Press the ► key to enter the Battery Menu as shown in figure 2-4.

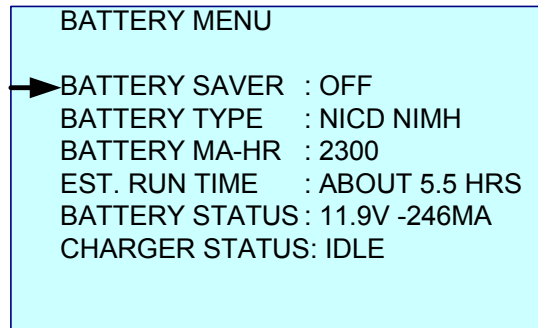

Figure 2-4

BATTERY SAVER

Use ► to turn BATTERY SAVER on and ◀ to turn BATTERY SAVER off. When on, the TDR will automatically power down if no key is pressed in 5 minutes. This is a normal power down that will save all settings and re-store them on the next power up.

BATTERY TYPE

There are three battery types: NICD-NIMH, ALKALINE, NONE. The battery charger will only operate when in NICD-NIMH. If alkaline cells or other than NiCd or NiMH cells are used this menu selection should be in alkaline or none to prevent attempting to charge the cells.

CAUTION – The E20/20’s smart charger is not designed for charging Lion cells. Attempting to do so may result in damaged cells, damage the instrument and potentially cause a fire. This type of damage is not covered under warranty.

BATTERY MA-HR

Use this feature to change the mAhrs setting to the re-chargeable cell rating installed. This will adjust the charging and compute the correct time remaining per the cell’s rating.

The remaining items in the BATTERY MENU are status only and not user adjustable.

EST. RUN TIME

This time is based on the cell rating (mA), charge status, and cell age. New NiMH cells rated at 2300mA and in good condition will provide about 5.5 hours continuous operation.

As the cells age this run time will reduce even with a maximum charge.

Run time = 0 hrs – Normally the result of installing new cells or

selecting a battery type of alkaline or none. The charger will need one complete charge or discharge period to compute the new cell's run time.

Run time = N/A – Normal indication when the TDR is on external power.

BATTERY STATUS

Displays the cells' current voltage level (normally 11.5 to 8.6V) and mA of charge or discharge. Discharge, indicated by a negative mA, indicates the instrument is running on battery power. Charging, indicated by a positive mA, indicates external power is applied to the batteries. The level of mA will depend on the Charger Status' state.

CHARGER STATUS

STATUS	MEANING	LED
IDLE	No external power applied, cells are too hot or cold to accept a charge, or BATTERY TYPE is set to Alkaline or None and the charger is off.	Not lit
BATT CHK	External power is applied and charger is checking the cells.	Red blink
PRE CHRГ	Pre-Charge - Low current charge is being applied to provide initial charge.	Red solid
CHARGING	Full charge power is being applied	Red solid
TRICKLE	Cells are 95% or more charged and being topped off. This state prevents overcharging	Green blink
FULLY CHARGED	Cells are 100% charged	Green Solid

DATE AND TIME MENU

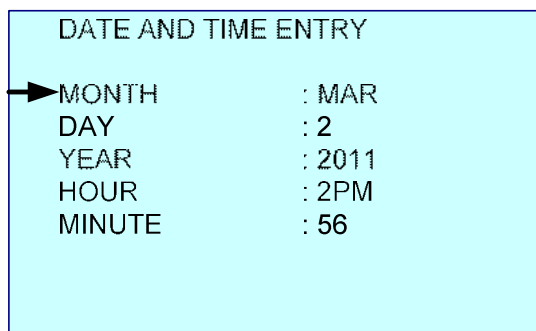

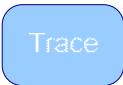

Figure 2-5

Use the ▲ ▼ keys to select the date or time entry to change and the ◀ ▶ keys to

cycle through the selections. Press the  to save and return to the "Meter" menu.



The “Trace” menu permits viewing or setting all of the following Measurement Screen options:

Z SCALE (OHMS) – Impedance scales: 20, 50, 100, 200, 500, and 1,000 Ohms. The best starting point is a scale that places the cable’s impedance (Z_0) about mid-scale on the display.

TRACE RANGE – Sets the plot width. Ranges in feet are: 10, 20, 50, 100, 200, 500, 1,000, 2,000, 5,000, 10,000, and 20,000. Ranges in meters are: 2, 5, 10, 20, 50, 100, 200, 500, 1,000, 2,000, and 5,000.

START DISTANCE – Sets the left plot starting point xx ft (m) away from the TDR’s connector. The plot will show the start and end range at the bottom. Cursor distances will still be measured from the TDR’s connector or end of a “Test Lead Null” if on.

Press the ► then use the alpha-numeric keypad to



enter the start distance desired, then press to save and return to the menu.

MICROFAULT – This feature provides two modes of locating small faults on coax cables. Use the ◀▶ keys to select one of the following modes:

OFF – TDR presents normal impedance trace on Measurement Screen.

KINKS ONLY – TDR presents an amplified trace of reflections from kinks, crimps or crushed areas along the cable. The cable’s Z_0 is plotted at the bottom of the plot with the faults appearing as upward refecton spikes. See figure 2-6A.

ALL FAULTS – TDR presents a reduced Z Scale trace with dribble up removed to maintain a flat trace at Z_0 . By eliminating the dribble up and reducing the Z Scale small faults of any kind can be more easily identified. See figure 2-6B

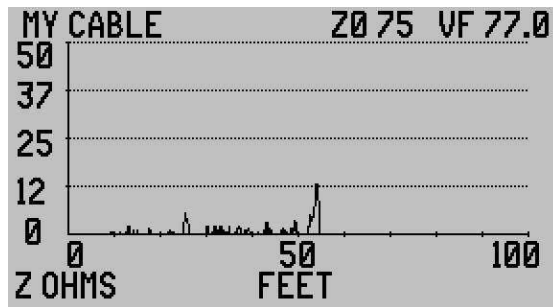

Figure 2-6A

In figure 2-6A the micro fault at about 25 feet (5 Ohms) may not be service affecting. The micro fault at 55 feet (12 Ohms) is most likely service affecting. Anything over 15 Ohms is certain to affect service.

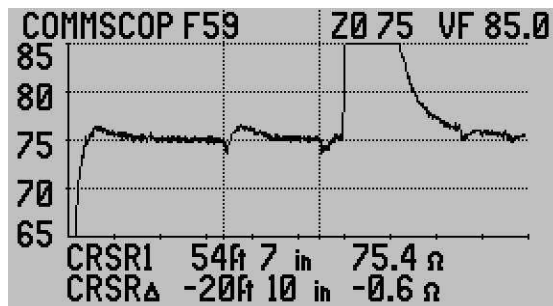

Figure 2-6B

In figure 2-6B there are two small faults. The first fault is marked by Cursor 2 at about 34ft is a worn barrel connector and the second marked by Cursor 1 is a kink in the cable. Both could be service affecting at higher frequencies.

TEST LEAD NULL – ON or OFF

Use ◀▶ to turn ON or OFF. When ON the stored test lead's length will be removed from the cable's distance measurements. The Measurement Screen indicates Null is on when "(NULL)" appears below the plot on the left side.

TEST LEAD NULL – Store a Test Lead's Length



With the cursor arrow at TEST LEAD NULL press the  to measure a test lead and store its length. Connect the desired test lead and follow the on-screen instructions which will direct marking the end of the test lead with the cursor and press ENTER again to store that length, turn Null on, and return to the Measurement Screen.

NOISE FILTER

Use ◀▶ to turn ON or OFF the filter. When ON this filter reduces unwanted noise signature on the cable's trace.

Cables

This menu provides for two ways to select a cable:



1. From a pre-stored Cable List of up to 64 cables.
2. By manually entering a cable's impedance, velocity and name.

Other features are VELOCITY SRCH. for finding an installed cable's VF, SAMPLE A CABLE for finding the VF of a reel or box's cable using a sample length, and DISTANCE UNITS for setting feet or meters for the measurements.

PICK/EDIT LIST - PICK

The Cable List contained in the TDR will be either pre-loaded at the factory depending on model type or can be loaded from one of the Cable Lists stored in ETDR PC Vision software. The Cable List contains 64 cable types with their impedance (Z_0) and velocity factor (VF). Use the ▲▼ arrows to move the bold



highlight to the desired cable type and press  to select, then  to return to the Measurement Screen.

NOTE: To move up or down the Cable List faster press and hold the ◀▶ keys or to move by a page at a time use the ◀▶.

PICK/EDIT LIST – EDIT

To edit this list select a cable type to replace or an empty cable list slot and press



. Then follow the on-screen instructions to enter new description, impedance (Z_0), and Velocity Factor (VF).

NOTE: In the Cable List open slots are indicated in two ways:

OPENnn – These are open slots at the end of a factory list that with nn= the number of open slots remaining.

OPEN Z=33 VF=33 – These are open slots created by deleting a cable from the list, then uploading the list to the TDR. Z_0 and VF must contain some value to avoid list format errors, so 20 is the default set by the ETDR PC Vision.

MANUAL ENTRY

Use for a one time entry not to be saved on the Cable List. Permits entering a cable's name or description, impedance (Z_0) and velocity factor (VF). Use ▼▲ to select the menu item to change and ▶ to select. Make the desired entry using



the alpha-numeric keypad and press

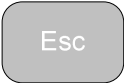

to save and exit back to the Cables menu. Press at Cables menu to return to the Measurement Screen.

VELOCITY SRCH.

This feature permits adjusting a cable’s Velocity Factor (VF) manually to get the end of the cable or a known event on the cable’s trace to match a known length measurement or measurement on a cable plat. Follow the on-screen instructions. After the “Preparing” screen use the ◀▶ keys to move the active cursor to a known “target length” on the cable. When the cursor is in position, use the ▲▼ keys to adjust the VF higher or lower until the cable’s end or known event is at the cursor. The resulting VF will be the cable’s actual VF.



Press to accept the modified VF and return to the Measurement Screen.

NOTE: The term “Target Distance” refers to a distance obtained by actual length measurement in feet or meters, cable plat, or best estimated distance.

SAMPLE A CABLE

This feature permits measuring a cable’s velocity factor. It requires knowing the cable’s length in feet and inches or meters to make that entry valid and obtain an accurate velocity factor. A cable’s point-to-point measurement on a cable plat will suffice as long as there are no undocumented maintenance loops in the cable. Use ▶ to select this feature and follow the on-screen instructions to connect the cable, leave the opposite end open and mark the end with the



cursor. Pressing will calculate and display the velocity factor to accept or decline for use.

DISTANCE UNITS

Use the ◀▶ keys to switch between FEET & METERS.

SELECTED CABLE

Displays the selected cable for final review prior to Pressing  to exit to the Measurement Screen. The TDR will re-calibrate to the new cable type's impedance (Z_0) and Velocity Factor (VF) prior to measuring.

Measurement Screen and Controls

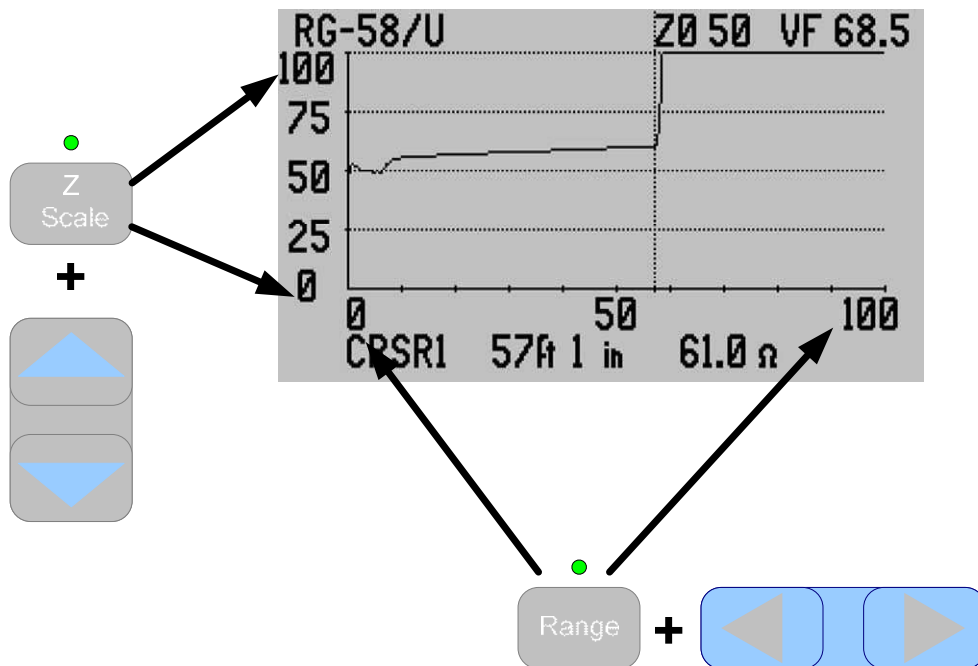

Figure 2-7

Figure 2-7 is an example of the measurement screen. The plot displayed has two axis controls. The "Range" key, when active, used with the ◀▶ keys control the display range. The "Z Scale" key used with the ▲ ▼ keys control the impedance scale.

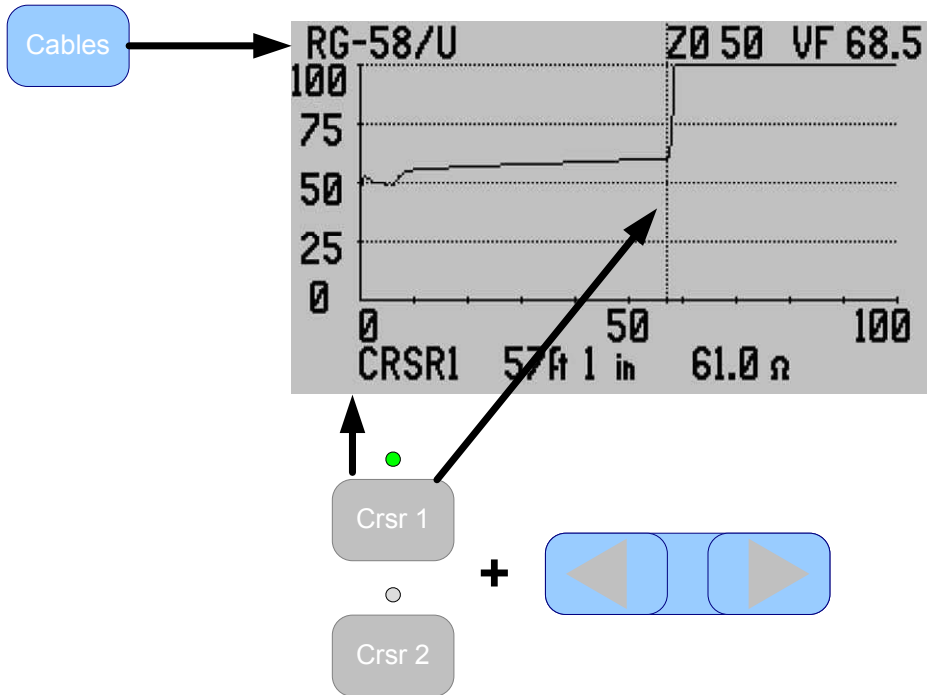

Figure 2-8

Figure 2-8 shows the Measurement Screen and "Cable" menu which controls the cable type selected. Once selected, it will display at the top of the Measurement Screen.

The "Crsr 1" and/or "Crsr 2" keys used with the ◀▶ keys control the active cursor, which in this screen is Cursor 1 only. If Cursor 2 is activated, both cursors will appear on screen and both cursor LED's will be green. The last cursor key pressed will have control of the ◀▶ keys. That cursor's data will appear in the top data line and the difference in the measurement to the other cursor will appear in the bottom data line (CRSRΔ). See Figure 2-9.

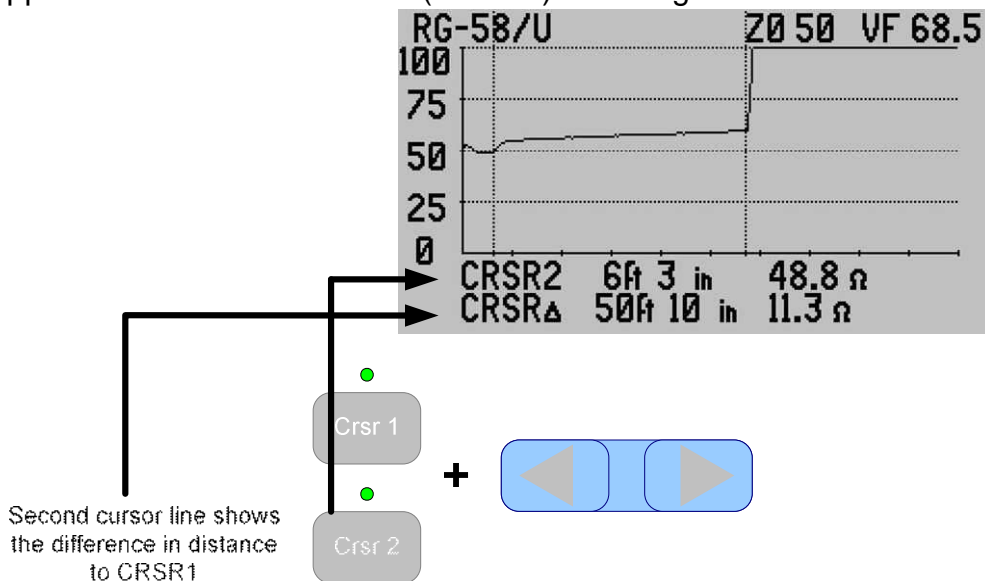

Figure 2-9

NOTE: When the differential reading from the active cursor is from the left to the right the differential range readings will be positive. When the differential reading from the active cursor is right to left the differential range readings will be negative. The differential impedance readings will depend on the slope of the trace going positive or negative.



The **Tone** key is activated when pressed and the green LED is lit. A Tone menu will be presented in the LCD as shown in Figure 2-10. Use the **▲▼** keys to select the tone frequency desired and the **◀▶** keys to select having the tone steady or warbled. Items with a frequency shown will cause the TDR to generate that frequency on the cable. Standard inductive amplifiers (Probes) will pick up the tone to ID the cable or cable pair. If “Pocket Toners” are selected the TDR will generate the DC voltage required to turn on their tone attachment at the far end of the cable.

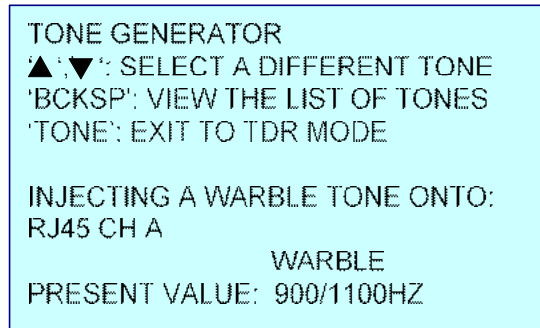

Figure 2-10

- NOTES:
1. Toner should be used on battery power only. Use with the AC charger connected will cause 50/60Hz interfere with the tone frequencies.
 2. When the Tone feature is active the TDR measurement will not be active.
 3. When the Tone feature is active the Battery Saver time-out will be suspended to prevent automatic turn-off of the TDR.

The information in Section 2 is for basic operation. Full cable parameters, testing explanations, test and measurement setups, and example traces are covered in Section 3.

NOTE: Avionics TDR users should pay particular attention to Section 3 pages 52 – 54 concerning testing Single-Wires in a harness. Their testing presents some unique cable impedance changes throughout the harness that requires complete understanding to correctly interpret the Avionics TDR’s traces.

Section 3 – Test and Measurement Setups

Introduction

Sections 1 and 2 in this manual and the TDRs' Basic Guide describe the TDR, menus, Function keys, and provide a general background on how the TDR operates. This section of the manual will expand on that information to provide:

- Basic test setups and measuring coax, twisted pair, and other cable types
- Background on cables' impedance, velocity factor, and loop resistance
- More complex test setups and measurements
- Advanced features in the TDR

Coax Test Setups

Coaxial cable, aka coax, comes in thousands of styles, types, and brands. All are constructed around a single premise. It uses a center conductor surrounded by a shield and the two are separated by a dielectric material or air. The shield is not a passive element, but an interactive conductor along with the center conductor. Together they can provide a relatively high quality, low loss, signal path to transport RF signals from a transmitter to an antenna or antenna to a receiver or between transmitter and receiver equipment i.e. CATV broadband media. Having a properly grounded shield around the center conductor also works to counter-act on electro-magnetic interference (EMI), aka "ingress."

Coax cable also has a variety of connector types. The table below will translate which TDR connector is best suited to the type of connectors used in individual applications:

TDR Coax Connector (see Section 1 for models)	Coax Cable Connector Type	Recommended Adapter	AEA Technology Part Number
N female	N type	None or double male if required	
N female	BNC type	N to BNC female	0070-1190
N female	TNC type	N to TNC female	0070-1134
N female	SMA type	N to SMA female	6025-0260 (kit)
N female	UHF SO-239 type	N to UHF female	0070-1195
(continued) N female	Other	N male to other male	None

		or female connector via matched 4-6ft (1-2m) coax lead	
BNC female	BNC type	None or double male if required	
BNC female	N type	BNC male to N male or female connector via matched 4-6ft (1-2m) coax lead to keep strain off the BNC connector	
BNC female	TNC type	BNC male to TNC male or female	
BNC female	SMA type	BNC male to SMA male or female	
BNC female	UHF SO-239 type	BNC male to UHF male or female	
BNC female	Other	BNC male to Other male or female via match 4-6ft (1-3m) lead	

The term “matched” refers to matching the lead’s impedance with the impedance of the cable to be tested. The TDR can measure through a mis-matched test lead, but matching is a better method.

Coax Cable Parameters

There are a large number of parameters published for each brand and type of coax. They include conductor size and type, shield type, cable diameter, weight, and tables for attenuation at specific frequencies. For the use of the TDR we are primarily interested in only three cable parameters:

- Impedance (Z_0)
- Velocity Factor (VF) aka Velocity of Propagation (VP or VoP)
- Loop Resistance

To obtain the best specifications for the cable being tested visit the manufacturer’s web site and search for the cable type and part number to download complete specifications. Also pay attention the tolerances (+ / -) for each as this is important for permitted deviations.

Impedance

Impedance specifies the total AC and DC resistance a cable offers to the RF signal being transmitted on the cable. It’s important the cable’s impedance matches the equipment it is connecting. Otherwise there will be unwanted signal reflections in the system. Measured as VSWR (Voltage Standing Wave Ratio) or

SWR (Standing Wave Ratio). All systems will have some VSWR, but when measured, a low ratio is better (1:1.25 in radio systems or less is generally good). All systems have their designed maximum acceptable VSWR. If a cable's impedance is not within its specifications or the cable has deviations due to damage, poor connections, moisture, etc. this will increase the VSWR. This is where using a Step TDR to measure the cable's impedance becomes critical.

Coax cables come in a variety of impedances. Their impedance is designed in by the manufacturer and in most high quality coax will be very close to the published specified impedance. Additionally, the specification will have a +/- value associated with the impedance that should be noted. The following table is a list of popular impedances and their common applications.

Coax Impedance (Z_0)	Common Applications
50 and 52 Ohm	Almost all RF communications or radio applications including broadcast, land and marine mobile, cellular, amateur radio (HAM), etc.
62.5 Ohm	Specialized broadband applications. Example is the old Ethernet thinnet and thicknet applications now considered obsolete
75 Ohm	Video mainly CATV and CCTV systems
93 -125 Ohm	Special applications not commonly used

On the TDR'S's display there is an impedance scale (Z Scale) on the left side of the plot. The scale can be controlled using the Z Scale function key (see Figure 3-1) or by pressing the Trace key, selecting Z SCALE (OHMS), and use the ◀▶ keys to step the scale up or down in set increments (20, 50, 100, 200, 500, and 1KOhms). See figure 3-2.

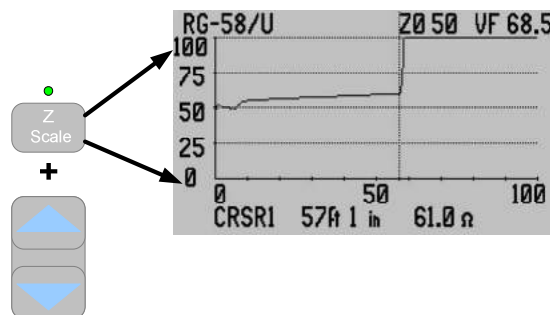

Figure 3-1

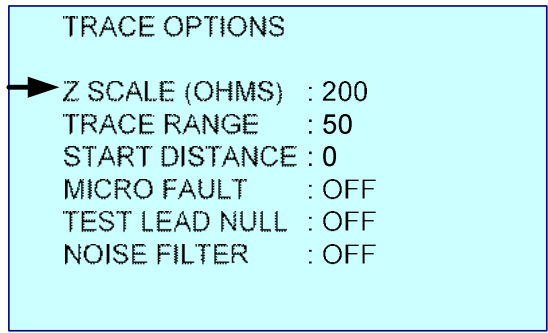

Figure 3-2

The Cable List in the TDR contains various cable types and their impedances. The Cable Menu also has an option to enter a cable type, Z_0 and VF manually. When a specific cable type is selected or entered, it will set the TDR's Z_0 to that impedance value. The TDR will keep the selected Z_0 value centered if the impedance scale is lowered. See figure 3-3 and note the Cable's Z_0 is 75 Ohms and the Z Scale is set to 100 Ohms . This causes the Z Scale to display from 25 to 125 Ohms to keep the 75 Ohm cable trace centered. For higher Z Scales (200, 500 and 1K Ohms) the cable's Z_0 will appear lower in the display.

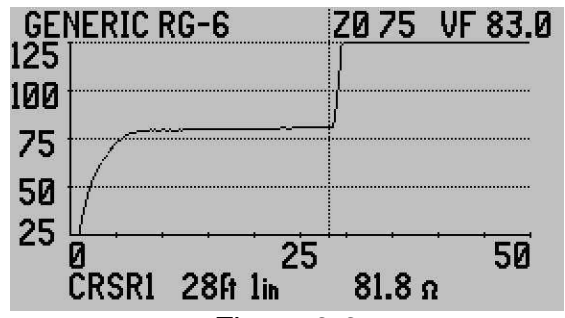

Figure 3-3

Velocity Factor (VF)

This parameter has a number of names all referring to the speed at which an AC signal will travel on a particular cable. It's also known as VP or VoP – Velocity of Propagation and NVP – Nominal Velocity of Propagation. The velocity is expressed as a fraction of the speed of light in a vacuum. The figure 67.6c indicates a signal on this cable will travel at 67.6% the speed of light in a vacuum.

At the time the cable is constructed the VF is designed into the cable. However, manufacturers are permitting a percentage of allowable deviation from their published VF specification. Most high quality coax cable, as delivered from the manufacturer, will not deviate more than 1 or 2% from the manufacturer's specification. However, once un-spoiled, pulled to installation, cut, and spliced

and/or connectorized, VF deviations can begin to affect the cable's overall VF. As long as quality installation practices are used per the cable and connector manufacturer's recommendations these will be minimal. Older cable installations, depending on application and location, can suffer from wear and tear, abuse, moisture intrusion, etc. All of which will slow a cable's VF in spots and produce TDR distance variations. As discussed in Section 2, the TDR determines distance on a cable by multiplying time by the VF to obtain distance to marked events on the cable. If the reflections are delayed, even slightly in one spot on the cable, all the distance measurements after that spot will be off by a factor of that delay.

All that being said, it's best to find a way to verify a cable's velocity either by measuring a sample length or measuring a known physical distance to the end or an event on the cable and using that obtained VF. Ways of accomplishing this will be covered later in this section under "Advanced Features."

The basic methods for setting a cable's VF is by selecting the cable type from the TDR's Cable List or entering the cable's parameters manually. This will set the TDR's VF. All time based measurements of reflections as marked by the cursors will be converted to distance using this VF. In figure 3-4 the Cursor 1 is marking the open end of the cable at 57ft 1 inch (17.4m) based on a VF of 68.5c. If the VF is set correctly, that distance will be correct. If the TDR's VF is set too slow the cable's trace will appear shorter than its physical length. If the TDR's VF is set too fast the cable's trace will appear longer than its physical length.

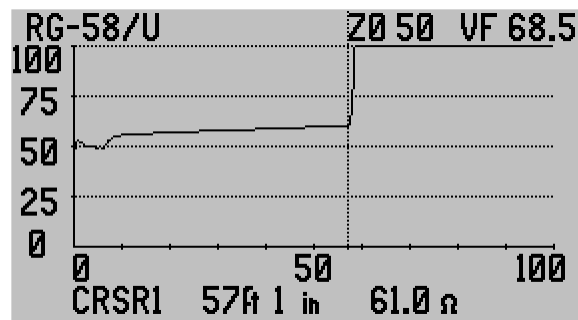

Figure 3-4

NOTE: "Jacket length" is a term used to indicate a cable's cut length or actual physical length. "Electrical length" is used to define a cable's TDR measured length based on a specific velocity. When a cable cut to jacket length has multiple conductors (i.e. twinax or triax cable), the different coax paths may have slightly different electrical lengths if the same VF is used to measure each coax conductor. The percent of distance variation depends on VF variations between them.

Loop Resistance

Loop resistance is defined as the DC resistance of the two conductors in a cable as measured by an Ohm meter at one end and having a zero Ohm short between the conductors at the opposite end of the cable. In the case of a coax cable, that would be a short between the center conductor and shield. Resistance specifications are normally published separately for the center conductor and shield as the DC resistance in one direction over 1000 feet (300m). The center conductor will have the higher resistance and the shield a lower resistance due to the nature of their construction. To calculate the total loop resistance, add the two resistances, center conductor and shield. Since this value is linear over the length of the cable it will divide evenly for shorter lengths. 100ft (30m) of cable will have 10% the loop resistance as the total calculated value for 1000 feet (300m) of the same cable.

While the Ohm meter requires a zero Ohm short be placed on the conductors at the far end of the cable to read the loop resistance, the TDR does not. It will add in the loop resistance for the conductors being measured whether the far end is open or shorted. This added resistance will cause the TDR's trace to have an upward slope over the length of the conductors known as "Dribble-up." The amount of dribble-up is relative to the amount of DC loop resistance that is added to the impedance measurement. Cables with relatively small center conductors will have higher loop resistances than cables with larger center conductors. As an example: 75 Ohm hard-line cables which have diameters ranging from about .400 to 1.125 inches (10mm to 32mm) will have nominal loop resistances of 10 to 2 Ohms/1kft (300 meters) respectively. However, 75 Ohm drop cable (significantly smaller and more flexible) will have a nominal loop resistance of 25-40 Ohms/1kft (300 meters) depending on type and brand.

Figure 3-5 is an example of how adding the resistance to the impedance measurement can be valuable in finding poorly performing cables. Cursor 2 is positioned on the end of 50 Ohm test lead at 6ft 3inches (1.9m) and reads relatively close (-1.2 Ohms) from specification. Cursor 1 (data not shown) is positioned at the end of the 50 foot (15.2m) cable. The CRSR Δ (difference) reading between the cursors shows an 11.3 Ohm gain over 50 feet. The cause is a combination of slightly high impedance at the cable's start and loop resistance shown by the dribble-up in the trace. While the dribble-up may be within specification, added to the higher than specified impedance this cable is less than optimum for use in a 50 Ohm system.

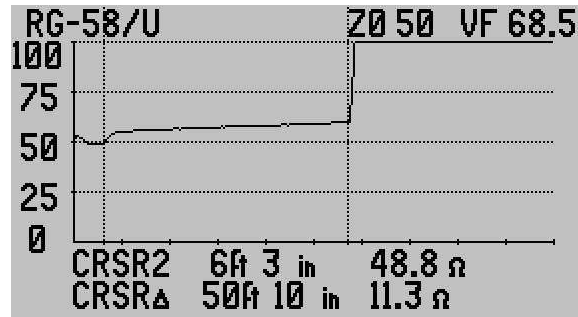

Figure 3-5

For more information and details on cable impedance, velocity, and loop resistance refer to the following AEA Technology, Inc. Application Notes:

AN200 – Basic Theory of Operation

AN203 – Getting the Most from Your TDR

AN204 – Impedance Shifts

AN210 – Cable Resistance (Coax)

AN220 – Cable Resistance (Twisted Pair)

The application notes are included on the enclosed E20/20 TDR and Avionics TDR CD or are available on our web site at

<http://www.aeatechnology.com/software/application-notes>.

Coax Cable Connections

In most cases, coax cable is connected directly to the TDR or through a connection adapter. In some cases via a test lead. If the test lead and adapters are all well matched, this generally results in a smooth transition from the TDR to the cable under test. See figures 3-6 and 3-7.



Figure 3-6

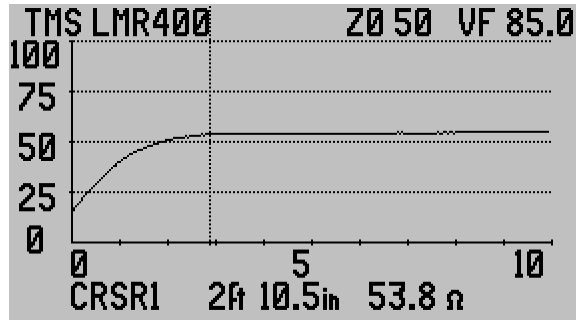

Figure 3-7

In this example the transition to the cable under test is normal with no impedance deviations as in figure 3-4. The TDR'S's soft impedance zone is close to the TDR's connector on the left of Cursor 1. This zone is not a dead zone as in pulse TDR's. If there was a fault in this 2ft 10inch (850mm) zone it would show as an open, short, or serious impedance bump/dip in the trace. The soft impedance zone is the result of the TDR's waveform requiring time to fully develop on the cable. After this zone the TDR's cursors will read the impedance correctly. The best zone to read the cable's impedance is generally 5-10ft (1.5 to 3.0m) from the TDR. This is clear of the soft impedance zone, but not so far down the cable as to be affected by dibble-up (loop resistance added to the impedance).

In some cases the correct adapter is not available or the coax cable to be tested does not have a connector yet attached. In these cases the F-to-alligator clips or BNC-to-alligator clips leads can be used. Figure 3-8 and close up figure 3-9 show the proper connection. Red clip to center conductor, black clip to shield so the center conductor of the cable is feeding the center conductor of the TDR's coax port. Additionally, the twist in the lead's wires should be maintained as much as possible. This will reduce the impedance bump as the signals and reflections pass through the 100 Ohm lead. Refer to figure 3-8's LCD screen and figure 3-10, a bit map capture of the TDR's LCD, to note the bump in the trace just to the right of the cursor. If the leads are un-twisted this impedance bump will be much larger. Once through the alligator leads the E20/20 will return the trace to the nominal 50 Ohms impedance in the cable under test.

NOTE: The F-to-alligator clips and BNC-to-alligator clips leads can be un-twisted when required to reach separated connectors in a center conductor and shield or twisted pair under test. However, the penalty is a larger impedance bump at the alligator clips lead and more time to return to the cable under test's nominal impedance. This bump can be reduced by placing your hand(s) across the un-twisted leads to reduce the impedance. Be careful not to touch the metal on the clips or cable end and alter normal results.



Figure 3-8



Figure 3-9

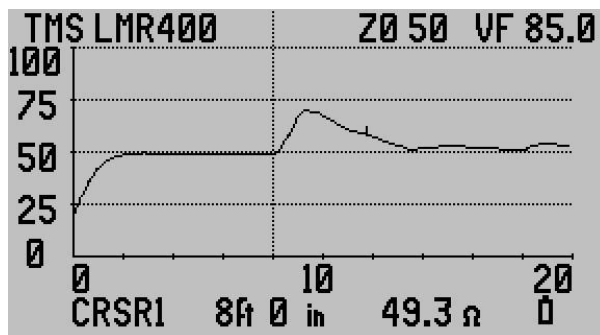

Figure 3-10

Example Coax Cable Traces

The following are examples of good and faulted traces for coax cables:

Good 50 Ohm Test Lead – figure 3-11

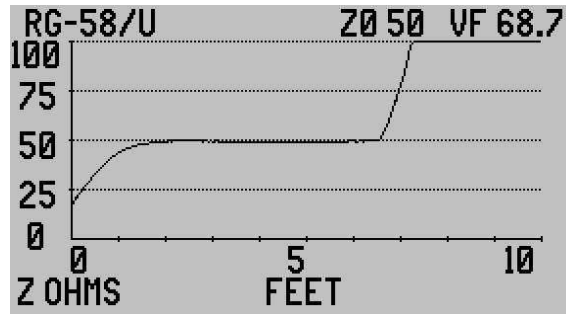

Figure 3-11

Good 50 Ohm cable about 53 feet (16.2m) – figure 3-12

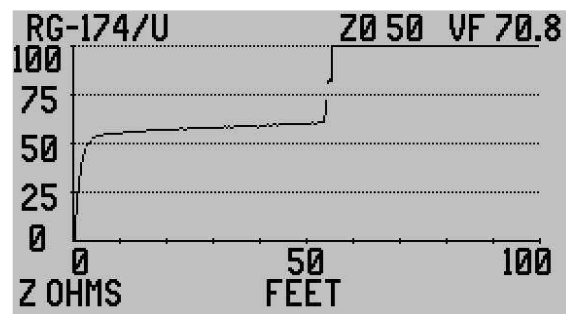

Figure 3-12

50 Ohm coax with series resistive fault – figure 3-13. Cursor 2 (left cursor) marks the fault, a step up in impedance that never lets the trace return to normal and stays added to the total impedance and loop resistance. RG-174 is a small diameter coax with a high loop resistance due to the thin center conductor, hence the more dramatic dribble-up in the trace. Cursor2 (right cursor) marks the open end of the cable. The total length is the distance to Cursor2 + Cursor Δ (distance between Cursor 1 and 2) or 99 feet 2 inches (30.2m).

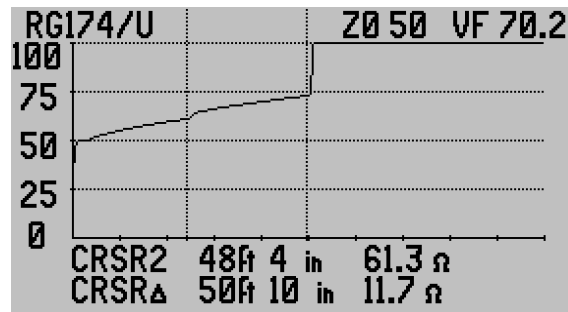

Figure 3-13

Wet 75 Ohm hard-line coax – figure 3-14. Looking at the trace starting at the left is the test lead connection using F-to-alligator clips leads to bare coax, hence the up bump in impedance at about 2ft (60cm). Moving right Cursor 2 is next at 12ft 6 inches (3.8m) marking a relatively dry section of the cable. Finally, Cursor 1 at 17ft 1 inch (5.2m) beyond Cursor 2 marking the open end of the cable. The dips and noise are the result of wet sections so none of the distances can be trusted. The cable is actually longer than the 29ft 7 inches (9m) indicated by the cursors total.

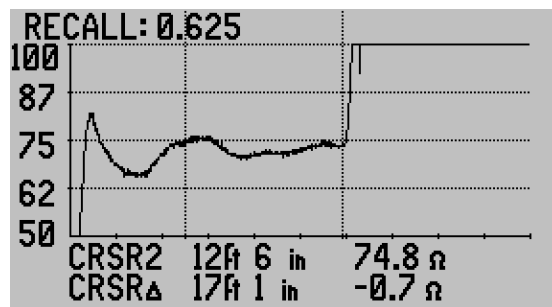

Figure 3-14

75 Ohm drop cable with a low impedance lead in and poor barrel connector – figure 3-15.

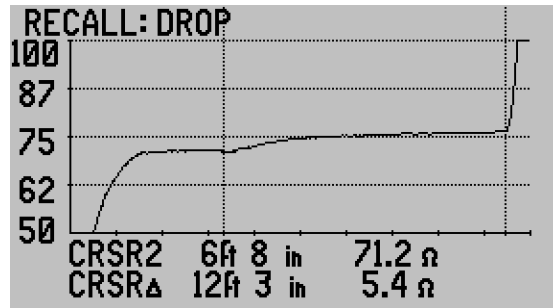

Figure 3-15

75 Ohm drop from the premise to an aerial tap at 60ft (18.3m) – figure 3-16. The up bump and arced upward trace at the tap is typical of the electronics in the tap. TDR's can't see through electronics so they produce either a gentle roll down or up depending on the impedance from the circuits.

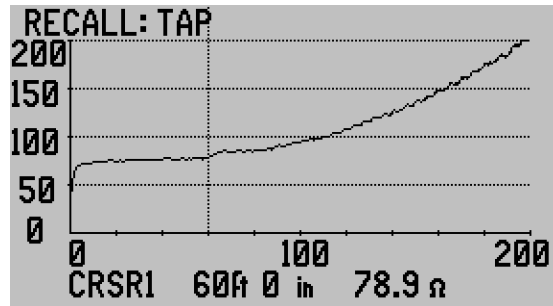

Figure 3-16

Twisted Pair Test Setups

Twisted pair cable comes in a wide variety of types and sizes from 900 pair telecommunications cables down to a single twisted pair in an individual jacket. Most common are the 2, 3, and 4 pair telecommunications and 4 pair Local Area Network (LAN) cables we find in offices and homes. They are categorized and labeled by the Telecommunications Industry Association (TIA) 568-C Standards as Category 2 through 6A (aka Cat 2-6A) and International Standards Organization (ISO) standards 11801 as Class A through F. Their applications are not limited to telecommunications and LAN, but other applications such as controls, signaling, low power, etc.

While their construction, materials and applications vary, twisted pair cables have some common traits that make their testing with a TDR easy to understand.

Some of the commonalities are:

- Characteristic impedance for each pair is generally 100 or 120 Ohms
- Each color coded pair is designed to be connected and operate as a pair
- Loop resistance is dependent on wire gauge and is linear over pair's length
- Multiple twisted pairs in the same jacket may or may NOT have the same VF
- Both their impedance and VF have much wider permitted deviation than coax. Impedance deviation is +/- 15% and velocity is +/- 6%
(Note: In Cat 5-6A LAN cables there are strict limits on the velocity deviation between pairs in the same jacket referred to as "Skew Limits."
Refer to TIA's 568-C or ISO 11801 testing requirements)

Connectors for twisted pair cables can also vary depending on application. The most popular connectors for horizontal LAN or telephone are the RJ-45 (4 pair), RJ-12 (6 pair) and RJ-11 (2 pair) connectors. When using TDR designated "Network" it will include an RJ-45 jack that can accommodate the smaller RJ-11 and RJ-12 connectors. However, the smaller RJ-11 and RJ-12 plugs do not always seat well in an RJ-45 jack. So be careful to ensure the contacts fully seat. Again, these connectors are so inexpensive, easy to install and reliable they are often used in non-telecommunications applications out of convenience. Other telecommunications connection points include 66 and 110 blocks, cross-connect boxes, pedestals and splice points. All the E20/20 TDR Network models also include an RJ-45-to-two pairs of telco clips (aka Popper Clips for the developer J.S. Popper, Inc.). These clips were designed specifically for the telephone companies for attaching to 66 blocks, or bare wire stripped or un-stripped wire using the bed-of-nails or spike in the clip. The wide opening alligator jaws also make them ideal to connect to electrical lugs and screws used at connection points as well as other connectors. 25 pair connectors, round connectors with pins and other connectors will normally require specialized test leads to mate the pair to the TDR's connector.

E20/20 TDRs with only an N or BNC connector can be connected to twisted pair wire and tested as well as using the RJ-45 connector found on Network models. Both the N and BNC models are provided with BNC-to-alligator clips test leads. Additionally, the N model includes an N-to-BNC adapter. These can be used to test twisted pair cables one pair at a time. If the Cable List does not include the type of twisted pair cable desired, one or more cables can be copied from other cable lists included with ETDR PC Vision software or a cable can be manually entered or edited into the TDR's Cable List. Refer to Section 5 for using ETDR PC Vision for uploading, downloading, and editing cable lists in the software.

Twisted Pair Cable Parameters

There are a large number of parameters published for each brand and type of twisted pair. They include conductor size and type, shield type (if shielded), cable diameter, weight, and tables for attenuation at specific frequencies. For the use of the TDR we are primarily interested in only three cable parameters:

- Impedance (Z_0)
- Velocity Factor (VF) aka Velocity of Propagation (VP or VoP)
- Loop Resistance

To obtain the best specifications for the cable being tested visit the manufacturer's web site and search for the cable type and part number to download complete specifications. Also pay attention the tolerances (+ / -) for each as this is important for permitted deviations.

Impedance

Impedance specifies the resistance a cable offers to the AC signal being transmitted on the cable. It's important the cable's impedance matches the equipment it is connecting with, otherwise there will be unwanted signal reflections in the system. This is referred to as VSWR (Voltage Standing Wave Ratio) or SWR (Standing Wave Ratio). All systems will have some VSWR, but when measured, a low ratio is better (1:1.25 in systems or less is generally good). All systems have their designed maximum acceptable VSWR. If a cable's impedance is not within its specifications or the cable has deviations due to damage, poor connections, moisture, etc. this will increase the VSWR. This is where using a Step TDR to measure the cable's impedance becomes critical.

On the TDR'S's display there is an impedance scale (Z Scale) on the left side of the plot. The scale can be controlled using the Z Scale function key (see Figure 3-17) or by pressing the Trace key, selecting Z SCALE (OHMS), and use the ◀▶ keys to step the scale up or down in set increments (20, 50, 100, 200, 500, and 1KOhms). See figure 3-18.

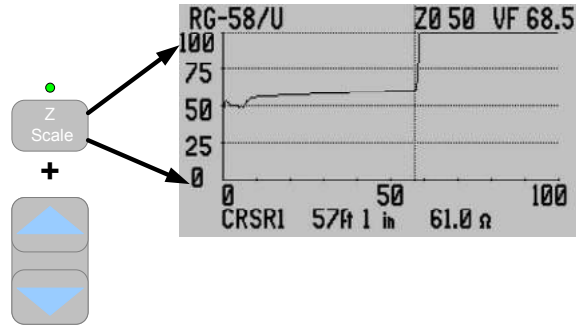

Figure 3-17

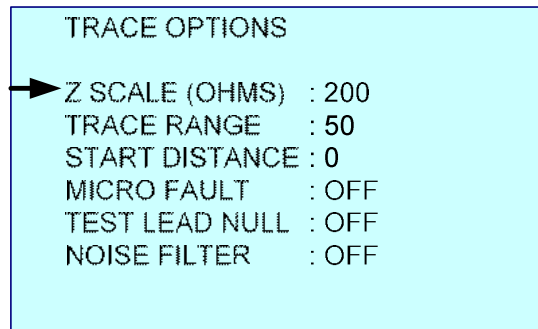

Figure 3-18

The Cable List in the TDR contains various cable types and their impedances. The Cable Menu also has an option to enter a cable type, Z_0 and VF manually. When a specific cable type is selected or entered, it will set the TDR's Z_0 to that impedance value. The TDR will keep that Z_0 value centered if the impedance scale is lowered. See figure 3-19 and note the Cable's Z_0 is 75 Ohms and the Z Scale is set to 100 Ohms. This causes the Z Scale to range from 25 to 125 Ohms to keep the 75 Ohm cable centered. For higher Z Scales (200, 500 and 1K Ohms) the cable's Z_0 will be lower in the display.

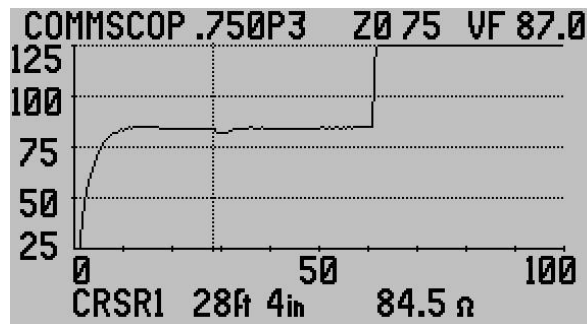

Figure 3-19

Velocity Factor (VF)

This parameter has a number of names all referring to the speed at which an AC signal will travel on a particular cable. It's also known as VP or VoP – Velocity of Propagation and NVP – Nominal Velocity of Propagation. The velocity is expressed as a fraction of the speed of light in a vacuum. The velocity of 67.6c indicates a signal on this cable will travel at 67.6% the speed of light in a vacuum.

At the time the cable is constructed the VF is designed into the cable. However, manufacturers are permitted a percentage of allowable deviation from their published specification VF specification. Most high quality twisted pair cable, as delivered from the manufacturer, will not deviate more than 2-3% from the manufacturer's specification. TIA standards for Cat 3 – Cat 6A permit as much as $\pm 6\%$. However, once un-spoiled, pulled to installation, cut, and spliced and/or connectorized, VF deviations can begin to affect the cable's overall VF. As long as quality installation practices are used per the cable and connector manufacturer's recommendations these will be minimal. Older cable installation, depending on application and location, can suffer from wear and tear, abuse, moisture intrusion, etc. All of which will slow a cable's VF in spots and produce TDR distance variations. As discussed in Section 2, the TDR determines distance on a cable by multiplying time by VF to obtain distance to marked events on the cable. If the reflections are delayed, even slightly in one spot on the cable, all the distance measurements after that spot will be off by a factor of that delay.

Out Side Plant (OSP) telecommunications cables are built to standards that tightly wrap the pairs inside a shield. This makes the VF factor for those pairs remain relatively the same from pair to pair. Premise multi-pair cables such as TIA Cat 2 – Cat 6A (ISO Class A to F) however, tend to have different VF between different pairs in the same jacket. This is mainly due to two factors: 1. When compared against jacket length the different twist ratios of the pairs make them physically longer or shorter than the other pairs in the jacket. Hence, when a single VF is used to measure each of the 4 pairs they will display different lengths. 2. Each pair was produced on a different machine or different part of the machine to achieve the different twist ratios. This induces another opportunity for the VF to be slightly different between pairs in the same jacket.

All that being said, it's best to find a way to verify a cable's velocity either by measuring a sample length or measuring a known physical distance to the end or an event on the cable and using that obtained VF. Ways of accomplishing this will be covered later in this section under "Advanced Features."

The basic methods for setting a cable's VF is by selecting the cable type from the TDR's Cable List or entering the cable's parameters manually. This will set the TDR's VF. All time based measurements of reflections as marked by the cursors

will be converted to distance using this VF. In figure 3-20 the Cursor 1 is marking the start of the cable after the test lead and Cursor 2 is marking the open end of the cable at 300ft (91.4m) based on a VF of 67.0c. If the VF is set correctly, that distance will be correct. If the VF is too slow the cable will appear shorter than its physical length (aka Jacket Length). If the VF is set too fast the cable will appear longer than its physical length.

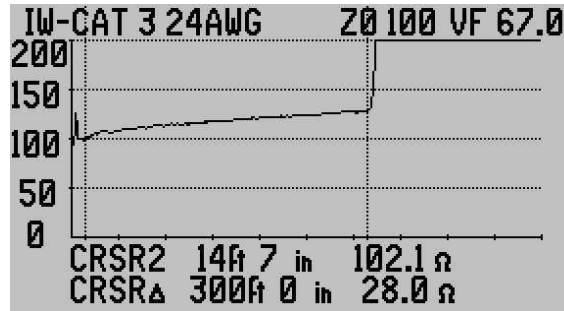

Figure 3-20

NOTE: “Jacket length” is a term used to indicate a cable’s cut or actual physical length. “Electrical length” is used to define a cable’s TDR measured length based on a specific velocity. When a cable cut to one jacket length has multiple pairs, each may have slightly different electrical lengths if the same VF is used to measure all the pairs. The percent of distance variation depends on VF variations between them.

Loop Resistance

Loop resistance is defined as the DC resistance of a pair’s two conductors in a cable as measured by an Ohm meter at one end and having a zero Ohm short between the conductors at the opposite end of the cable. Specifications for this resistance are normally published for one wire in one direction as the DC resistance over 1000 feet (300m). The wires in a pair are always the same gauge and therefore will have the same DC resistance. To calculate the total loop resistance, multiply the one-way resistance by 2. Since this value is linear over the length of the cable it will divide evenly for shorter lengths. 100ft (30m) of cable will have 10% the loop resistance as the total calculated value for 1000 feet (300m). See the Gauge to Resistance Table for a sample of OSP and Premise loop resistances:

Nominal Outside Plant (OSP) Loop Resistances

Wire Gauge	Loop Resistance per 1000ft (300m)	Loop resistance per 100 ft (30m)
19 AWG (0.9mm)	16 Ohms	1.6 Ohms
22 AWG (0.64mm)	32 Ohms	3.2 Ohms
24 AWG (0.5mm)	50 Ohms	5.0 Ohms
26 AWG (0.4mm)	80 Ohms	8.0 Ohms

Nominal Premise TIA Cat 5 and 6 Loop Resistances (ISO Class D and E)

Wire Gauge	Loop Resistance per 328 ft (100m)	Loop resistance per 100ft (30m)
24 AWG (0.5mm)	19 Ohms	6.0 Ohms

While the Ohm meter requires a zero Ohm short be placed on the conductors at the far end of the cable, the TDR does not. It will add in the loop resistance for the conductors being measured whether the far end is open or shorted. This added resistance will cause the TDR's trace to have an upward slope over the length of the conductors known as "Dribble-up." The amount of dribble-up is relative to the amount of DC loop resistance that is added to the impedance measurement. Cable's with relatively small conductors (24 & 26 AWG or 0.5 & 0.4mm) will have a higher loop resistance than pair's with larger conductors (19 & 22 AWG or 0.9 & 0.64mm). Refer to the OSP Table above.

Figure 3-21 is an example of a Cat 5 cable with good loop resistance. Cursor 1 is marking 329ft 2 inches (100m) from Cursor 2 and showing 18.1 Ohms difference. Specification for this Cat 5 cable was 19 Ohms ± 5% at 328ft (100m)

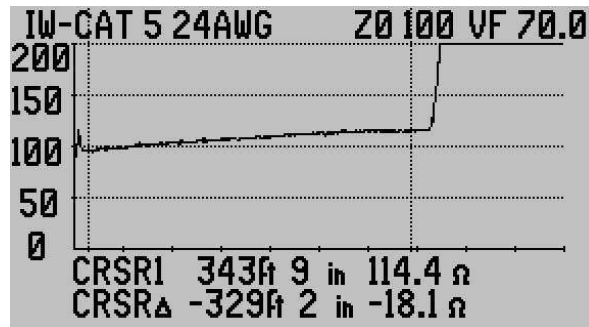

Figure 3-21

- NOTES: 1. On the 500ft range with 240 plot point on the display the closest positioning of the cursors to 328ft was 329ft 2 inches. This is a negligible distance with regards to measuring loop resistance.
2. The Cursor Δ (difference) figures appear negative because the measurement is reference from Cursor 1 to Cursor 2 moving right to left or towards the TDR. Pressing Cursor 2 key would change the top measurement to Cursor 2's distance from the TDR and the Cursor Δ values would remain the same, but become positive as they are moving left to right or away from the TDR.

For more information and details on cable impedance, velocity, and loop resistance refer to the following AEA Technology, Inc. Application Notes:
 AN200 – Basic Theory of Operation
 AN203 – Getting the Most from Your TDR
 AN204 – Impedance Shifts
 AN210 – Cable Resistance (Coax)

AN220 – Cable Resistance (Twisted Pair)

The application notes are included on the enclosed E20/20 TDR and Avionics TDR CD or on our web site at

<http://www.aeatechnology.com/software/application-notes>.

Twisted Pair Cable Connections and Pair Selection

In most cases twisted pair cable is connected directly to the TDR's RJ-45 input and pair selection is made using the Meter menu and INPUT CHANNEL: by pressing the ► to change the input to one of 4 pairs in the RJ45 connector. See figure 3-22.

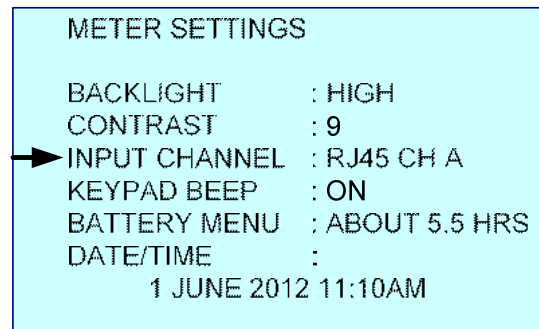

Figure 3-22

Each Channel A, B, C, and D represents a pair in the RJ45 connector. Refer to Appendix B for a table of input channels to cable pairs depending on the cable's wiring standard. When the AEA Technology Telco Test Leads (P/N 6020-0250) are connected, RJ45 Channel A connects to the red & black clips and RJ45 Channel B connects to the green & black clips. See figure 3-23.



Figure 3-23

Whenever the Telco Test Leads or other alligator clip leads are connected, the twist in the leads ends and the cable pair under test should remain as close as possible as in figure 3-24. This reduces any impedance bumps to their minimum at the connection points as shown in figure 3-25. As the leads and cable pair's wires separate the impedance between them will climb rapidly and the display will show a larger impedance bump at the connection point.



Figure 3-24

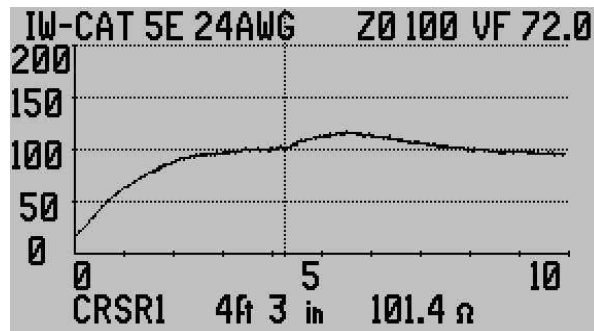

Figure 3-25

When a connection requires the clips and/or leads be separated be aware of this increase in impedance at the connection point. Figure 3-26 shows the same telco test lead connection's trace, but with separation between the clips and 2 inches (5cm) of wire un-twist.

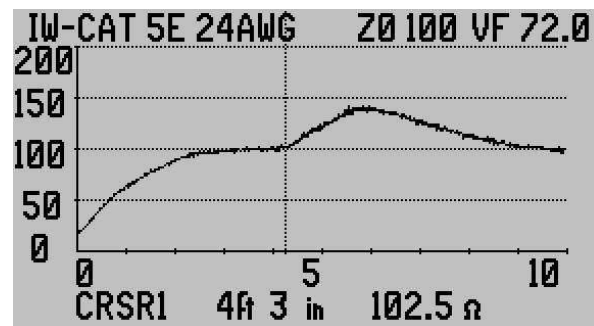

Figure 3-26

See AEA Technology's application note AN222 Telco Style Alligator Clips for more information about twisted pair connections. Application Notes are available

on the enclosed E20/20 TDR and Avionics CD or from our web site at www.aeatechnology.com.

The other way to connect a cable to the RJ-45 port is directly using either an RJ-45 (4 pair), RJ-12, (3 pair), or RJ-11 (2 pair) connectors. This type of connection negates having any impedance bump at the start of a trace. See figure 3-27. RJ-45 Channel to test pair selection is per the table in Appendix B.



Figure 3-27

The final connection method to be covered is using the Coax Port; N, BNC or F style to connect to a twisted pair. Using this method you lose the capability to connect up to 4 pairs at one time and selecting them via the RJ-45 port's Channels. However, if using a model without an RJ-45 Port, this still permits testing twisted pair cable. The connection table shown indicates the use of the included adapters that came with each model of the E20/20 TDR.

TDR Model	Adapters	Adapter Part Numbers
E20/20N TDR	N-to-BNC adapter and BNC to alligator clips test lead	0070-1190 0070-1221
E20/20F Network – CATV	F-to-alligator clips test lead	0070-1220
E20/20F Network – Telco	F-to-alligator clips test lead	0070-1220
E20/20B Network – VDV/RF	BNC to alligator clips test lead	0070-1221
Avionics TDR	BNC to alligator clips test lead	0070-1221

The example in figure 3-28 shows an E20/20F Network model using the F-to-alligator clips lead with twist maintained. Any minor impedance bump is not sufficient to display in the trace on the LCD.

Example Twisted Pair Cable Traces

The following are examples of both good and faulted twisted pair cables.

Good 370ft (112.8m) twisted pair cable with open end – Figure 3-30. Some noise is showing on the trace as un-terminated cable un-shielded cable is also an antenna.

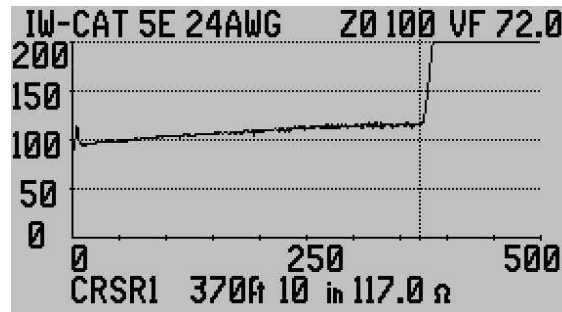

Figure 3-30

Same 370ft (112.8m) section of cable with a short at the far end – Figure 3-31
Note: The short also caused an increase in the noise on this pair due to local EMI environment. Using the Noise Filter in the Trace menu will eliminate the trace's fuzzy appearance.

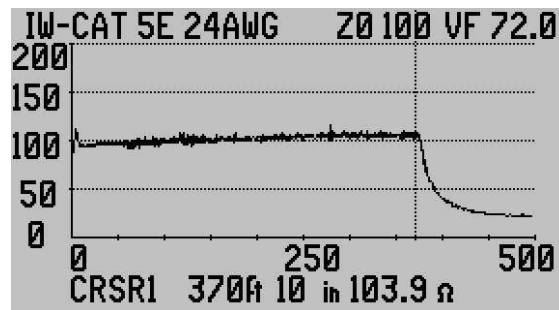

Figure 3-31

Twisted pair with a good splice – Figure 3-32. The minor impedance bump is due to the small amount of untwist of the pair to make the splice.

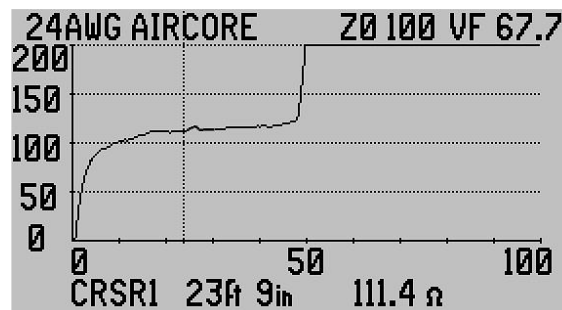

Figure 3-32

Twisted pair cable with a bad splice – Figure 3-33. Too much untwist at the splice.

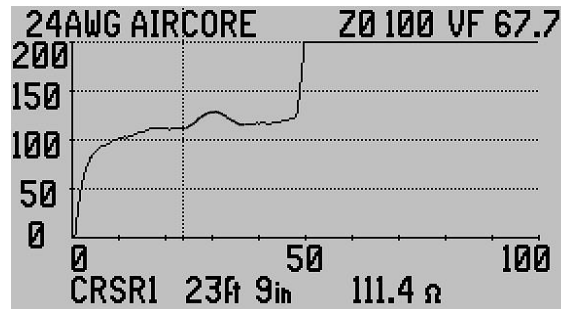

Figure 3-33

Wet twisted pair cable – Figure 3-34. Wet sections always show a dramatic dip in the impedance. Additionally the VF in the wet zone drops to some unknown value so distances from the start of the wet zone, 95ft (29m), on are not valid even after the wet section as the cable dries out and impedance returns to normal. Note the rise in impedance after the right cursor (CRSR1) as an example of the drying of the pair. Only the distance from the TDR to just before the wet zone can be trusted (CRSR2).

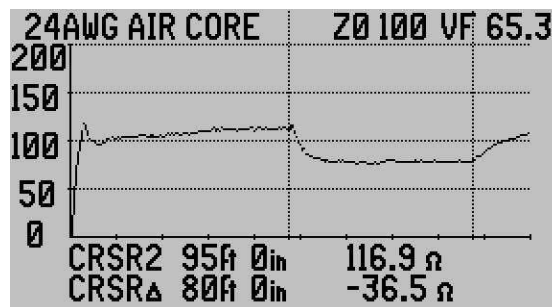

Figure 3-34

Bridged Taps are an auxiliary connection or drop cable from a main line. – Figure 3-35. Bridged taps are characterized by a downward dip in impedance to almost half the cable's Z_0 . This is the results of the TDR receiving reflections from two 100 Ohm pairs running in parallel. At the end of the tap the trace will return to normal impedance. This permits an accurate measurement of the tap's length. See figure 3-36 for a line drawing of a bridged tap.

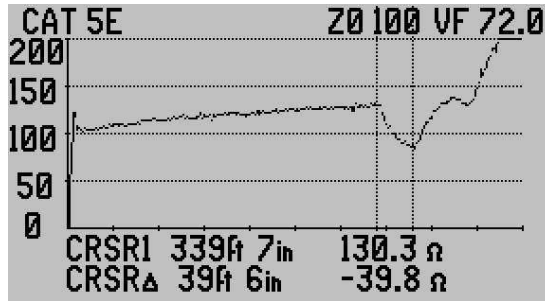

Figure 3-35

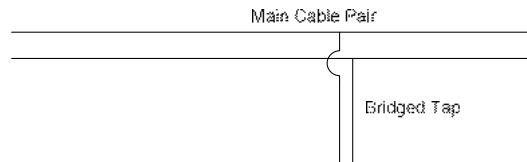

Figure 3-36

Split Pairs occur when one wire from one pair becomes crossed with one wire from an adjacent pair in a multi-pair cable – Figure 3-37. Since the adjacent pairs make looser contact in the cable jacket the impedance will rise after the split. When the error is detected, but corrected at a different connection point or splice the result is a re-split. Both the split and re-split can be seen in the trace and distance to each measured. A drawing of the split and re-split is shown in figure 3-38.

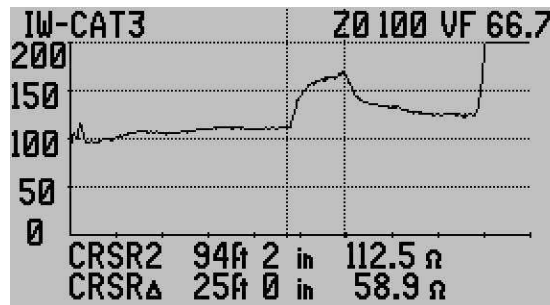

Figure 3-37

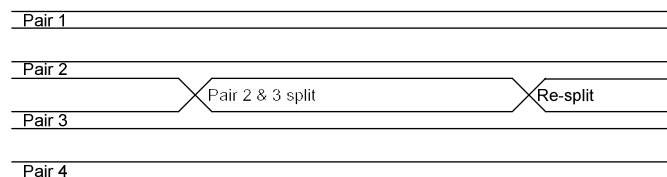

Figure 3-38

Normal loop resistance characterized by “Dribble-up” in the trace – Figure 3-39. Discuss earlier in the Loop Resistance section, this is an example of normal dribble-up and correct loop resistance reading for a 328ft (100m) section of

Cat 5e cable pair. TIA 568-C requirement is less than 20 Ohms for that length. The reading is accomplished by marking the desired section using Cursors 1 and 2. The Cursor Δ (difference) will display that section's loop resistance.

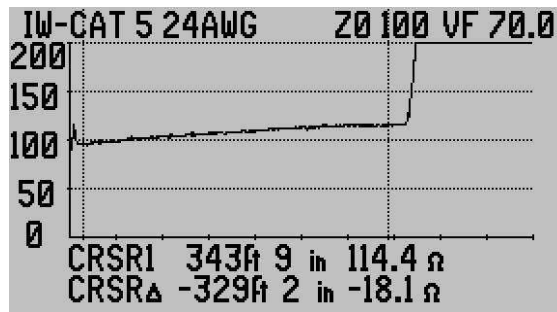

Figure 3-39

High loop resistance – Figure 3-40. Note the 328ft (100m) segment marked by Cursors 1 and 2 is now 27 Ohms. Normal should be 18-20 Ohms.

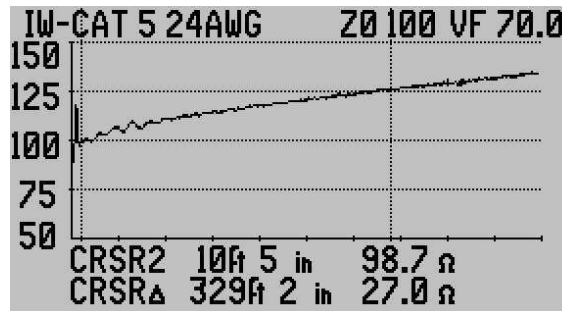

Figure 3-40

Measuring cable on a reel or in a box (spooled cable). One factor that can lead to a higher than normal loop resistance reading and display an erratic trace close to the TDR is measuring the cable while it is spooled or coiled up, even loosely. In that form the TDR signals create minor interference with each other. Figure 3-40 is an example of both issues. The loop resistance is too high and the first 75ft (22.8m) of cable display an erratic trace. Removing the cable from the spool or coil will correct this. Figure 3-41 shows a 1,000ft (305m) cable with 375ft (114.3m) removed from the box and laid straight. Note the smoother trace near the TDR and reduced loop resistance over that section as compared with the 641ft (195.4m) section still coiled in the box.

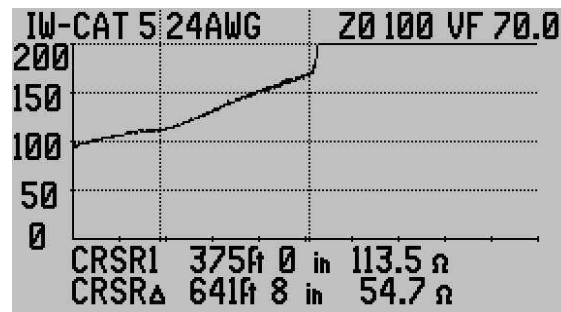

Figure 3-41

Intermittent Fault – Figure 3-42. Intermittent faults, open or short, will cause the TDR's trace to become erratic. Each updated trace will show a different pattern or return to normal then become erratic again when the fault returns. The best tracing method is to have one person monitor the TDR for change and the other person hand-over-hand along the cable, particularly at connection points, wiggle and bend the cable slightly until the intermittent is located.

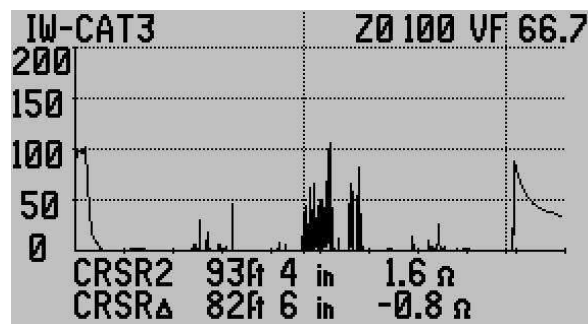

Figure 3-42

Series Resistive Fault – Figure 3-43. This fault is the results of corroded or dirty connection on one or both wires in a pair. The example shows a rather dramatic jump in impedance as the faults resistance is added to the pair's impedance. This jump will never return to normal impedance. Placing the cursor on either side of the fault will show it to be about 30 Ohms. Minor resistive faults (1-2 Ohms) will be much less dramatic, but still contribute to attenuation and signal

reflections on the pair. In the Advance Features section, we will cover methods to take a closer look at the trace and ensure the cable has the highest quality.

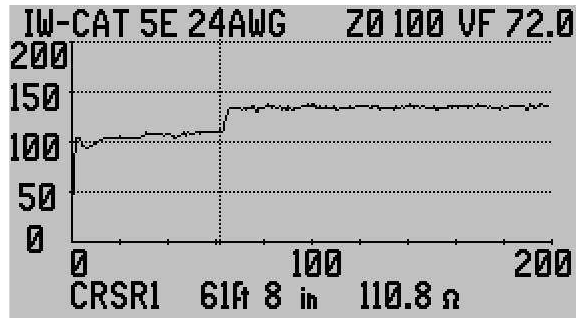

Figure 3-43

Testing Single Wires in a Harness

Testing single wires in a harness can be accomplished, but generally requires a good wiring diagram of the harness with pin-to-pin connection information. The reason is to find two single wires that can be treated as a pair. As explained earlier in Section 2, TDR's measure the characteristic impedance between two conductors separated by a dielectric material (insulation). In the case of testing a single wire it's important to locate an adjacent wire in the same harness, running a parallel length, and measure them as a pair.

The two single wires will travel the harness at varying distances from each other. Unlike twisted pair wires the wires' insulation will not be in constant contact. They will however, have other wires' insulation in contact with them and thus a dielectric path, but a variable path. This arrangement, combined with the number of wires in the harness and other factors, will cause the impedance to waver more over the length of the two single wires than if they were a twisted pair. Additionally, when the impedance varies the velocity factor also varies. Here are some general rules that affect measuring the two single wires:

Two Single Wires in a Harness Affects

Lowers Impedance & Faster VF	Raises Impedance & Slower VF
Two wires are closer together	Two wires are further apart
Large number of wires in the harness	Few wires in the harness
Tight bundling in the harness	Loose bundling in the harness
Single wires enter a larger bundle	Single wires enter a smaller bundle
Single wires merge to a larger harness	Single wires split to a smaller harness

The following are some measurement tips to use with single wires in harness:

1. Try to measure two single wires that both start at the same connector on the near end and terminate in the same connector at the far end. This should be the normal situation.

2. Compare the length of the two single wires to ensure it matches the wiring diagram's "Cut Length" for the wires or a best-as-possible measurement of the installed harness start to end. Remember, if one of the two wires is shorter than the other, the shorter wire is the electrical end of the pair.

3. When the pin numbers are located for both ends of the single wires, measure the pair open at the far end, then short the two pins at the far end. The short should appear on the trace at the same distance as the open to ensure:
 - A. The TDR is measuring the single wires you desire.
 - B. To be sure the wires at the far end are making good connection at those pins.

The following are some examples of single wires in a harness and the type of traces you can expect.

Figure 3-44 is an example of impedance (Z) variations over the length of two single wires in the harness. Cursor 2 marks the end of the test leads (50 Ohm coax with a short twisted pair to connectors lead at the end). Between Cursors 1 and 2, 19ft 4 in (5.9m) are the two single wires being measured as a pair with an open at the far end. At about 9 feet the impedance rises for the remainder of the run. This could indicate either the wires separated in the same bundle and never came close over the last 10ft (3m), or that section of the harness contains less total wires.

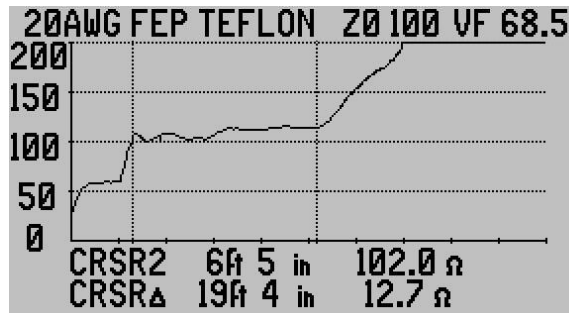

Figure 3-44

Figures 3-45 and 3-46 are examples of more wide variations in the two single wire's impedance. The same test lead is marked (CRSR2) as used in Figure 3-44 and the far end of the single wires is open as marked by Cursor 1. These are also good examples of measuring two single wires in vehicles. The harnesses in vehicles tend to be looser and cause wider variations in the impedance.

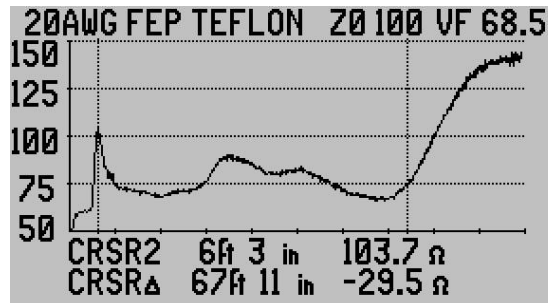

Figure 3-45

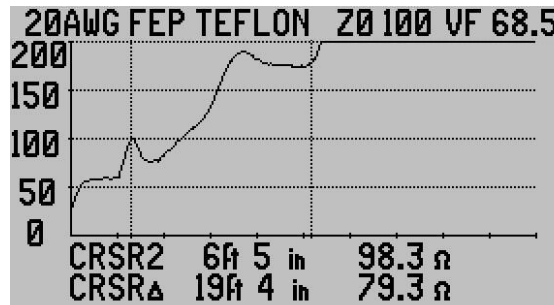

Figure 3-46

Figure 3-47 is an example of two single wires terminating in equipment at the far end. Note the slower upward trend and flattened trace at the end. In some cases the trace will roll off slowly down or be flat at about 100 Ohms as the TDR's signal is absorbed by an impedance matching device in the equipment. This emphasizes the importance of understanding the wires' distance to end connector and the wires' destination. In this case, the end was marked based on the known distance of two other wires in the same harness.

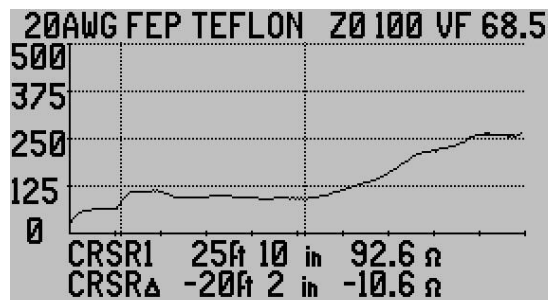

Figure 3-47

Figure 3-48 is an example of measuring one wire in the harness to the chassis or airframe to which the harness is attached. In figure 3-48 the impedance trace lowered, but in some cases the impedance will rise over the length of the harness. This will depend on the amount of contact the harness has to the chassis or airframe.

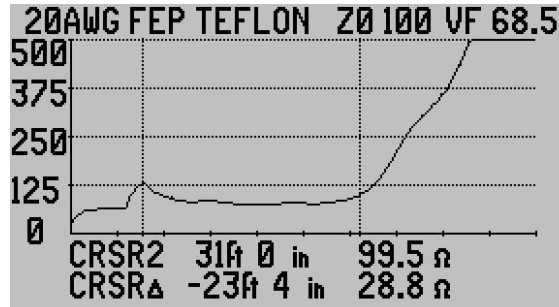

Figure 3-48

Testing Power Cables or Other Cables with Large Gauge Conductors

The E20/20 Step TDR can be used to measure power cables and other cables with relatively large conductors, but with some limitations. Previously in Sections 2 and 3 the subject of “Dribble-Up” or the addition of the cable’s loop resistance to the impedance over length was discussed. When cables with large gauge conductors are measured, the resistance of the conductors is so low compared with the capacitance of the dielectric separating them, the opposite condition can occur – “Dribble-Down.” This effect will vary with cable types and conductor sizes so there is no set chart on Dribble-Down/AWG over specific lengths. Generally, as the conductors increase in size the effect will be more dramatic.

With Dribble-Up the TDR can present longer distances as these cables are generally impedance rated between 50-120 Ohms and the TDR’s maximum scale is 1,000 Ohms. However, with Dribble-Down, if the cable’s impedance starts at about 100 Ohms, the trace will eventually reach zero Ohms and limit the usable range of the TDR. Refer to Figure 3-49. This example cable is losing about 14 Ohm per 1,000ft (304m). At this rate the trace will reach zero Ohms in about 7,000ft (2133m).

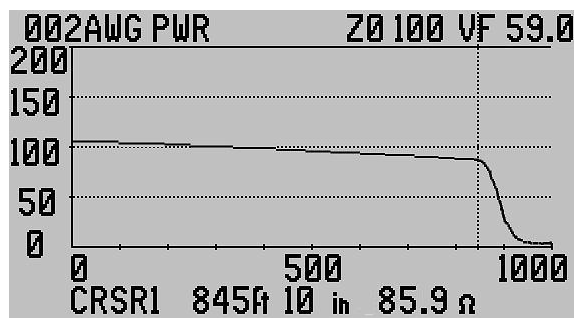

Figure 3-49

Additionally, manufacturers do not publish a velocity factor for power cables. Recommend referring to “Advanced Features” later in this section to determine the cable’s velocity factor using either the “VF Search” or “Sample a Cable” method.

Other E20/20 Step TDR Applications

- Measuring liquid tank levels
- Measuring soil or material moisture content
- Measuring terminators or resistors
- Measuring PCB traces

Please contact AEA Technology, Inc. for information on these applications and any other application the TDR can be used to obtain measurements. www.aeatechnology.com or 800-258-7805 or +1-760-931-8979.

Advance Testing Features

The examples shown so far have mostly been full traces and impedance scales about twice the cable’s Z_0 . The following features in the E20/20 TDR and Avionics TDR are designed to enhance the trace and provide improve the accuracy of measurements. They include:

- Z Scale Function – Zooming vertically on events
- Zoom Function – Horizontal or range zoom on cursor
- Start Distance
- Test Lead Null
- Micro-Fault detection
- Noise Filtering
- Velocity Search
- Sample a Cable

Z Scale Function

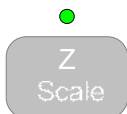

The  key works with the ▲ ▼ arrows to change the impedance scale shown on the left side of the plot. This scale can also be adjusted from the Trace menu by placing the menu cursor on Z SCALE (OHMS): and using the ◀ ▶ keys to change the scale setting. The fixed settings are 20, 50, 100, 200, 500, and 1K Ohms.

When a cable type is selected, its impedance becomes the TDR's Z_0 setting. If the Z Scale is raised to a higher setting the cable trace will be depressed in the display. However, when the Z Scale is reduced the TDR will keep the Z_0 setting in the center of the trace and lower scale will be plus and minus half it's value. See figure 3-50.

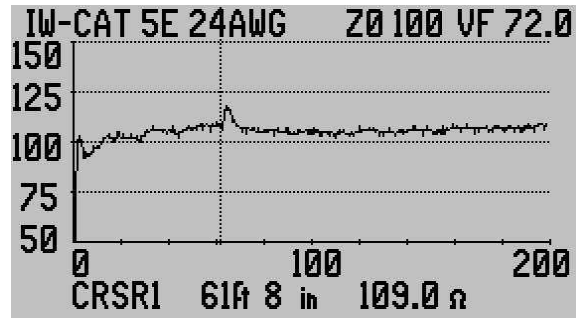

Figure 3-50

In this example the cable's $Z_0 = 100$ Ohms and the Z Scale is reduced to 100 Ohms, so the left scale now reads from 50 to 150 Ohms keeping the selected cable type's impedance centered. The result of doing this is an enhanced vertical scale to display even minor impedance changes. Best use for this is to look at and mark more accurately with the cursors any small impedance change noticed on a higher scale. In the example the cable has some noise on it which is also enhanced. Using the Noise Filter to eliminate this interference will be covered later.



Zoom Function

The Zoom Function is designed to reduce the range on either side of the active cursor so an event can be examined in higher horizontal resolution. Not only does a small event become easier to see, but the cursor positioning can be greatly improved for a more accurate distance reading. Since there are fixed number of data points that can be displayed on the LCD (240) the full range of data points is reduced to that resolution. Below is a table of the TDR'S's Ranges in feet and meters showing the cursor reading's minimum resolution on the LCD plot when using that range scale.

Range (Feet)	Resolution
10	0.5 inch
20	0.5 inch
50	2.5 inches
100	5 inches
200	8 inches
500	2ft 1 inch
1,000	4ft 2 inches
2,000	8ft 4 inches
5,000	20ft 8 inches
10,000	41ft 6 inches
20,000	83ft 4 inches

Range (Meters)	Resolution
2	1 cm
5	2 cm
10	4 cm
20	8 cm
50	20 cm
100	40 cm
200	80 cm
500	2 m
1,000	4 m
2,000	8 m
5,000	20 m

To activate and use the Zoom function, use the following steps and refer to figures 3-51 (pre-zoom) and 3-52 (zoom to 20ft on Cursor 1):

1. Place  or  at the point to center the Zoom (last cursor pressed will be the “active cursor” and used)

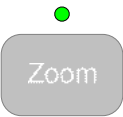
2. Press the  (note LED lit)
3. Press the ◀ once for each desired reduction in range (Minimum = 10ft or 2m). The range will be reduced on both sides of the active cursor. Some small centering adjustments are done in automatic by the TDR.
4. Press the ▶ key once for each desired expansion in range (Maximum = original range setting when Zoom was pressed).

5. Press the  key once to turn off this feature (note LED unlit)

NOTE: “ZOOM LIMIT” appearing in the range change screen indicates reaching either the 10ft (2m) minimum or the maximum limit that was the original range setting before pressing the Zoom key.

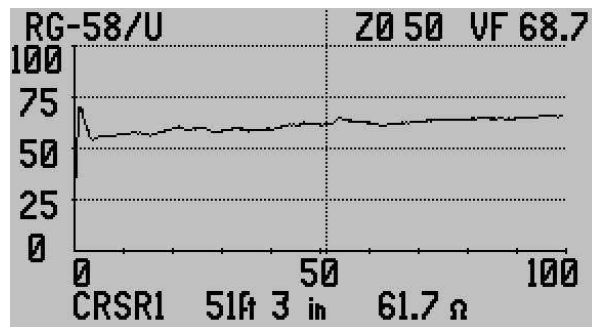

Figure 3-51

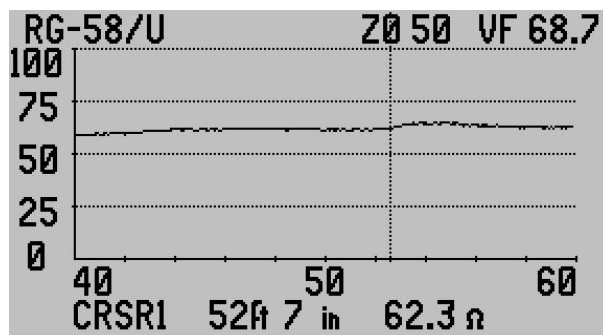
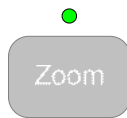



Figure 3-52

To re-position the cursor when in Zoom mode, press the desired cursor key once to regain control of the cursor. Then use the ◀▶ keys to re-position the cursor.

You can shift control between the two cursors as required. The LEDs and LCD legends operate as usual to indicate which cursors are in use and which one is active.



To restore Zoom operation press the  key once and use the ◀▶ keys to control the zoom range. (Alternate method, if only one cursor LED is lit, press the lit cursor key once to release cursor control. Now the ◀▶ keys control the zoom range).

In figure 3-52 note that Cursor 1 has been repositioned closer to the fault than it could be in figure 3-51. New distance to fault is now 52 ft 7 inches (16m).

Start Distance



The Start Distance for the range scale at the bottom of the plot can be adjusted. One use for this feature is aiding with trace display. If you have a 1,000 ft cable which the end of trace just slightly over runs the 1,000 ft range scale and the 2,000ft range scale uses only half the plot display, the Start Distance can be adjusted to use the 1,000ft scale (In the case of metric this would apply to a 200m cable which end of trace is just over the limit to display and the 500m scale only uses half the available plot area for the trace).

First, check the 100ft (30m) of the cable closest to the TDR for any faults. If that section is good, off-set the start by selecting Start Distance and entering 100ft (30m) to see the remainder of the cable to the end on the desired range.

The Start Distance can be adjusted using the following steps:

1. Press the  menu key. See figure 3-53
2. Move the menu cursor to START DISTANCE
3. Press the ▶ key. Then use the alpha-numeric pad to enter the desired start distance in feet or meters.



4. Press  to return to the Trace menu, then  to return to the measurement screen.

NOTE: This will off-set the start and end range shown on the LCD plot. However, the cursor distances will still be measured from the TDR's connector.

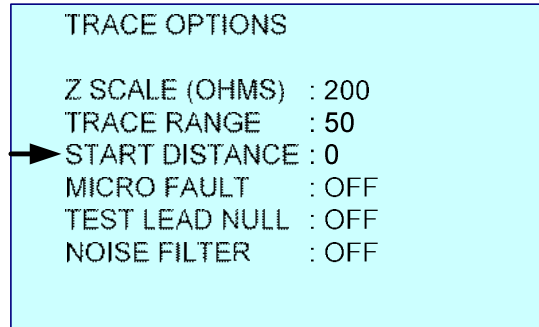

Figure 3-53

Figure 3-54 is an example Measurement Screen with 10ft (3m) of Start Distance (off-set). Note the Range Scale at the bottom of the trace is now set for 10 to 60ft (3-18.3m). The upward spike in the trace indicates the open end of the cable. The first 10ft (3m) of cable and any test lead are not in the trace, but the cursor reads the cable's correct length of 58ft (17.7m). Using the Start Distance off-set by 10ft (3m) permits a better resolution view on the 50ft (20m) Range than moving up to the 100ft (50m) Range.

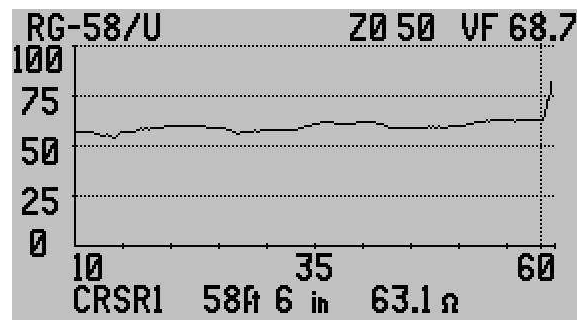

Figure 3-54

CAUTION: This feature will set an intentional blind zone between the TDR's connector and the start of the trace. Be sure to check the first section of cable from the TDR's connector to the planned Start Distance before setting an off-set and to reset the Start Distance to zero when its use is completed.

Test Lead Null

This feature is designed to measure any test lead in time-delay to end of the lead and remove the lead from the cable's measured distance. By measuring the lead in time-delay rather than distance it eliminates the VF. This way if the VF of the test lead is different than that of the cable being tested there will be no affect on the cable's distance measurement.

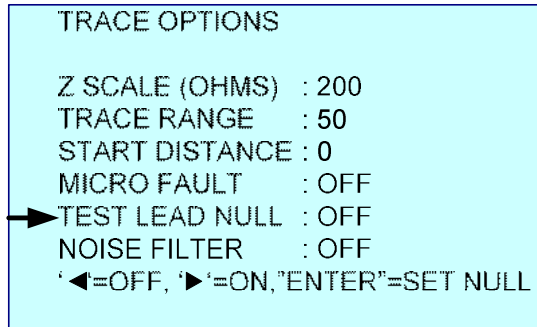





Figure 3-55



Use the following steps to turn ON or set up Test Lead Null (refer to figure 3-55):

1. Press the  key
2. Move the menu cursor to TEST LEAD NULL.
3. Press the  to turn Null ON, or press  to set a new test lead null.

NOTES: A. If Test Lead Null was previously set and is now turned ON, that previously nulled lead length will be removed from the trace.
 B. Only one test lead null can be stored and used. Pressing enter and setting a new test lead null distance erases the previous test lead stored.

4. If ENTER was pressed, follow the on-screen instructions to measure and enter a new test lead's null length.
5. When back at the Measurement Screen note the test lead no longer appears in the trace and either cursor will measure zero at the end of the test lead (left edge of plot). Also note the word (NULL) appears in the plot's range line at the left.

To remove the Test Lead Null:

1. Press the  menu key
2. Move the menu cursor to TEST LEAD NULL.
3. Press the  to turn Null OFF

NOTES: 1. When Test Lead Null is turned off, the measured test lead will remain stored in the TDR. It can be recalled by turning Test Lead Null ON.

2. If Start Distance other than zero is entered and Test Lead Null is turned ON at the same time, the Test Lead Null will take effect after the Start Distance (off-set). Example: With a Range set to 20ft (5m), a Start Distance of 10ft (3m) is entered, and Test Lead Null of approximately 3ft (1m), the display will actually start at approximately 13ft (4m). A cursor placed at the far left of the plot display will show the 10ft (3m) of off-set, but not the 3ft (1m) of Test Lead Null. See figure 3-56.

3. When Test Lead Null is on, the plot display will show the word (NULL) on the left side of the range scale after the start distance. See figure 3-57. The cable under test is a 51ft (15.5m) attached to a 7.5ft (2.3m) test lead that has been removed from the trace using Test Lead Null. Also missing from the trace is the first 10ft (3m) of the cable. However, the cursor marks the correct distance to the end of the cable.

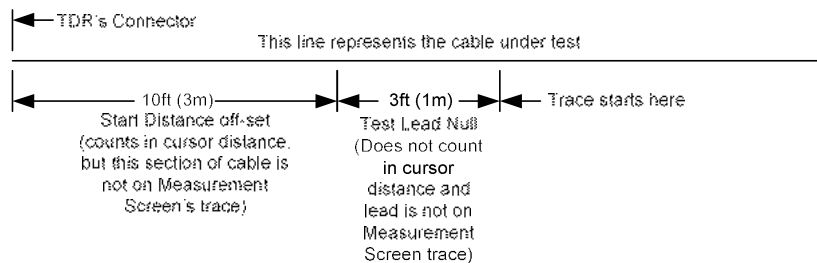

Figure 3-56

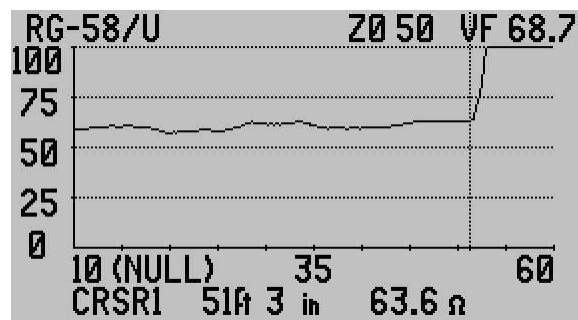

Figure 3-57

Test Lead Null Hints:

Pre-Stage the Measurement – Before entering Test Lead Null, set the Range and Impedance Scale for the optimum view of the test lead in the LCD plot. Example: for a 6ft (2m) 50 Ohms test lead, Set the Range to 10ft or 5 meters and the Z Scale to 100 Ohms. Then position Cursor 1 at the end of the lead.

Short Leads – If a short test lead is used it may be difficult to see the open end close to the TDR's connector. Solution is to short the end of the test lead to obtain a sharp downward turn at the test lead's end, then mark the end of the test lead.

Test Lead Null and Start Distance – Recommend performing the Test Lead Null first, then set the Start Distance. This is required in the case where the Start Distance is longer than the test lead.

Micro Fault Locating

Micro Fault locating is designed to expose potential service affecting faults hard to detect on coax cables using the normal impedance trace. Micro Fault is located in the Trace menu as shown in figure 3-58.

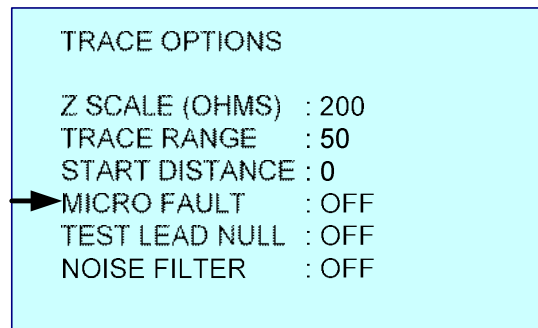

Figure 3-58

MICRO FAULT – This feature provides two modes of locating small faults on coax cables. Use the ◀▶ keys to select one of the following modes:

OFF – TDR presents normal impedance trace on Measurement Screen.

KINKS ONLY – TDR presents an amplified trace of reflections from kinks, crimps or crushed areas along the cable. The cable's Z_0 is plotted at the bottom of the plot with the faults appearing as upward reflection spikes. In figure 3-59 the micro fault at about 25 feet (5 Ohms) may not be service affecting. The micro fault at 55 feet (12 Ohms) is most likely service affecting. Anything over 15 Ohms is certain to affect service.

ALL FAULTS – TDR presents a reduced Z Scale trace with dribble up removed to maintain a flat trace at Z_0 . By eliminating the dribble up and reducing the Z Scale small faults of any kind can be more easily identified. In figure 3-60 there are two small faults. The first fault is marked by Cursor 2 at about 34ft is a worn barrel connector and the second marked by Cursor 1 is a kink in the cable. Both could be service affecting at higher frequencies.

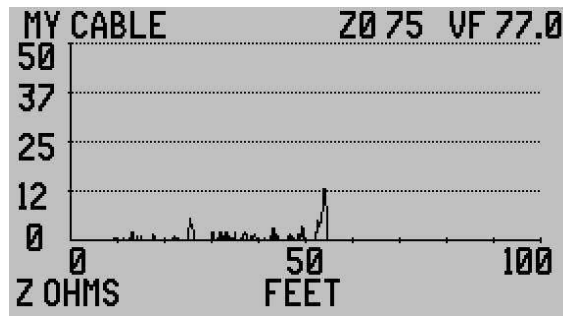

Figure 3-59

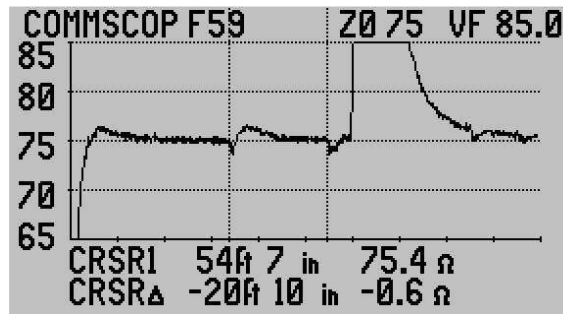

Figure 3-60

Noise Filter

Electromagnetic Interference (EMI) or noise is everywhere in our environment unless you are in a Faraday Cage or similar shielded room. Cables, particularly unconnected cables, are also antennas. The type and amount of EMI they pick up will be determined by the type of cable, coax or twisted pair, quality of shield grounding. Since Step TDR's are AC coupled to the cable under test any EMI or noise induced on the cable will be seen on the display along with the TDR's reflections. Figure 3-61 is an example of a noisy cable. Noise can also appear as intermittent spikes that appear in one trace and disappear 2 seconds later in the next trace or change position along the trace.

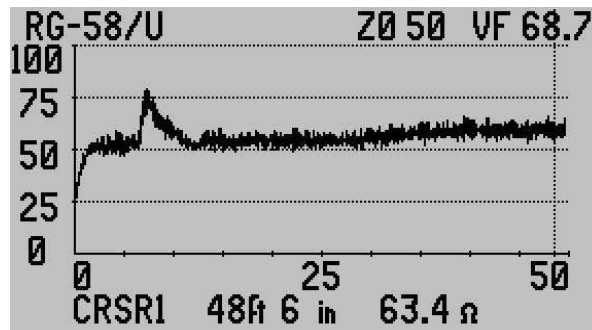

Figure 3-61

To eliminate this noise and get a better view of the cable's impedance trace turn ON the NOISE FILTER using the ►key as shown in figure 3-62.

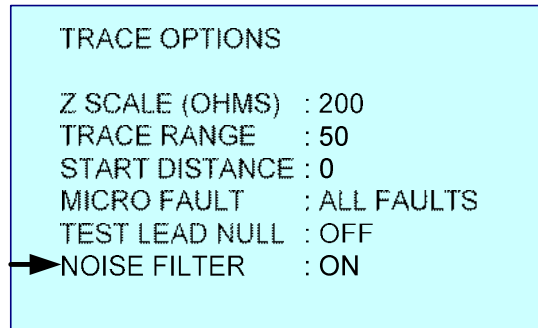

Figure 3-62

With the Noise Filter ON the same cable shown in figure 3-61 now appears as a clean trace in figure 3-63.

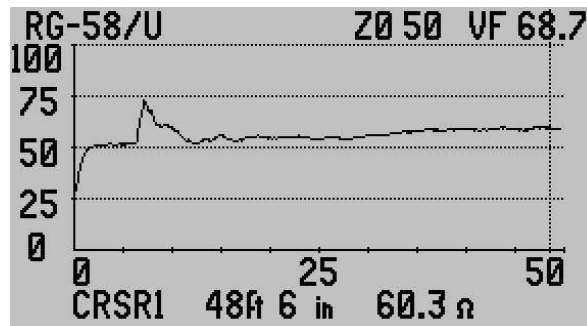

Figure 3-63

Noise or Signal Detection:

Leave Noise Filter OFF – With normal operation and the noise filter OFF the E20/20 TDR is a good detector for CATV signal, reverse ingress on drops, hard line, or at the premise. In other applications it will detect improperly grounded antenna leads, or ungrounded/poorly grounded shielded twisted pair cables.

Measuring Cable with Antenna Attached – If an antenna lead is measured with the antenna attached the input signal from the antenna may be too strong for the noise filter to suppress. The only solutions are to disconnect the antenna from the cable to be measured or locate and turn off the transmitter causing the excessive signal input.

CATV Cable with Broadband Signal – When measuring a 75 Ohm broadband cable with head end signal the noise filter should suppress the broadband signal. However, this suppression is relative to distance from the last amplifier and the number of taps between the amplifier and the

TDR. Some signal may remain on the cable when measuring close to the amplifier, but faults will still be visible. The quasi-square wave power (60 or 90VAC) must be removed from CATV cable before using the E20/20 TDR.

Velocity Search and Sample a Cable

“Velocity Search” and “Sample a Cable” are similar features with different applications:

Velocity Search is intended to find the correct velocity for an installed system when the measurement being used is to the nearest foot or meter and may have some estimated or known error attached. Examples: for an installed cable with “As Built”, “Planned Installation”, or “Cable plat” drawings, or “Pole to Pole distances, or measuring wheels are being used as the distance guidance. This VF obtained by the TDR will also include VF variations as slow downs going through untwists at splices and VF variations between different manufactures cables used on the same run.

Sample a Cable is intended for using cable samples from a box or reel of cable, generally about 10ft (2m) to 50ft (15.2m) in length and which can be measured to the inch or centimeters with relative accuracy. This produces a more accurate VF calculation by the TDR when that VF is used on the rest of the cable from the same box, reel, or lot number. The result will be more accurate measurements. This feature also samples the impedance of the cable at the mid-range between the TDR and the cursor marking the end of the sample. If accepted, it will alter the cable’s Z_0 slightly.

Based on the above information, use the better of these two methods to obtain the most accurate VF.

Velocity Search

Velocity Search is a process entered via the Cable menu as shown in figure 3-64.

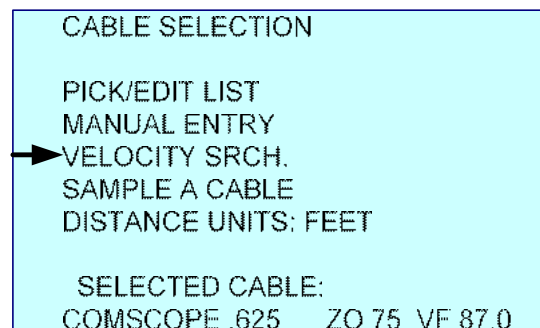

Figure 3-64

It involves connecting to an installed cable or cable system, select VELOCITY SRCH using the ► key and follow the on-screen instructions to start. Basically,

use Cursor 1 or Cursor 2 (active cursor upon entry will be available) and the ◀▶ keys to mark the distance on the display to the known distance for the end of the cable or to a known event on the cable. This mark may not align with the displayed trace's end of the cable or event on the cable. Then use the ▲▼ key to adjust the VF factor shown at the top left of the LCD. See figure 3-65. Holding the key down will make the VF change faster. Then use single presses to fine tune the VF.

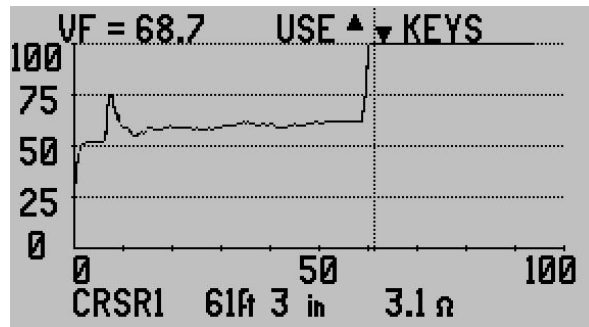

Figure 3-65

The end of the cable or the event chosen will move away from the TDR as VF increases and towards the TDR as the VF decreases. When the end of the cable or the known event matches the cursor marking the known distance, that VF is the installed cable's VF. See figure 3-66.

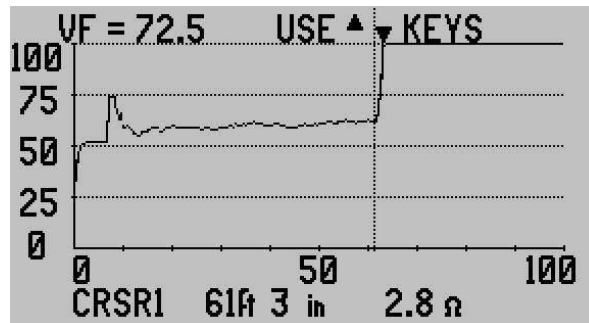



Figure 3-66



Press the  key to return to the Measurement Screen and use the obtained VF to measure other events on the cable. This will provide more accurate distances to the cable's end or other events. The Cable Type listed on the top of the LCD will now indicate "MODIFIED VF" however the Z_0 will remain the same and VF will be the new VF obtained.

NOTE: When a modified VF is obtained, write it down on paper and use the Cable menu's PICK/EDIT LIST to enter the new cable type. To modify an

existing cable on the list, select the cable type and press the  key. A menu screen will permit changing the VF and restoring the cable to the Cable List.

To enter a new cable type, scroll to an available "OPEN" slot, and press the

 key. Then follow the on-screen selections and use the alpha-numeric keys to make the changes to Cable Type, Z0, and VF.

NOTE: Slots marked "OPEN Z0=33 VF=33" were made open by erasing a cable using ETDR PC Vision. These can appear at any point on the Cable List. Slots left open on the original Cable List are at the end of the list and appear as "OPENnn Z0=10 VF=5.0" The nn = the number of remaining slots open on the list.

Sample a Cable

Sample a Cable is a process entered via the Cable menu as shown in figure 3-67.

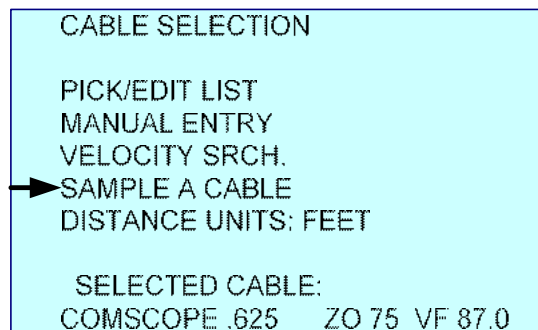

Figure 3-67

It involves connecting to a sample piece of cable of known measured physical length [recommend between 10ft (3m) to about 50ft (15m) in length], select SAMPLE A CABLE using the ► key and follow the on-screen instructions to start. Mark the end of the cable using the available cursor as shown in figure 3-68.

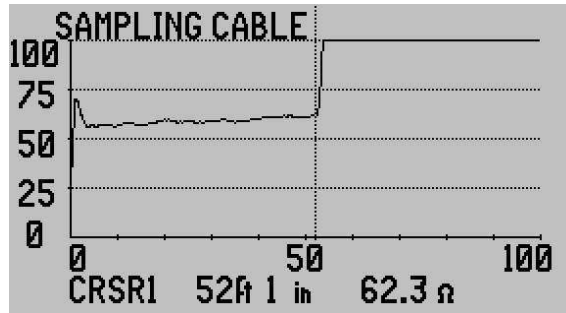



Figure 3-68



Press the  key to go to numeric entry screen. If measuring in feet, enter



the feet first, press  again and enter the inches of the sample cable.

If measuring in meters, enter the meters to three decimal places. Then



press  again to go to the SAVE RESULTS? (accept or decline) screen as shown in Figure 3-69.

NOTE: The Z_0 for the sample will be taken from about the middle of the cable from the TDR to the cursor. This will change the Z_0 slightly for the cable type selected. It can be edited back to the original Z_0 using the PICK/EDIT CABLE LIST in the Cables menu.

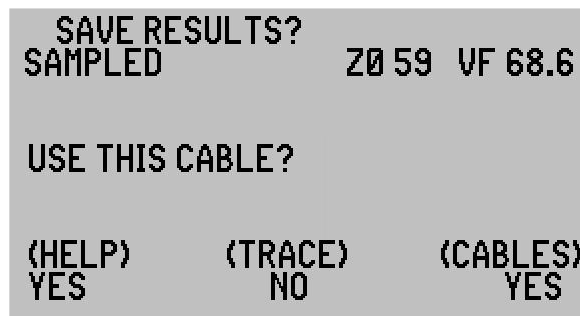





Figure 3-69

Pressing  or  keys will accept the Z0 and VF changes shown.

Pressing  will call a VERIFY choice screen. Pressing  again will discard the sampling results and return to the Measurement Screen with no changes.

NOTE: See the note following the Velocity Search instructions about how to save the sampled VF and Z₀.

This concludes the detailed operating instructions. There is more information on the subjects covered in this section and other subjects in AEA Technology's Application Notes. All our TDR Application Notes can be found on the enclosed CD or on-line at www.aeatechnology.com by clicking on "Application Notes" in the "Literature and Software" tool bar menu. Application Notes referring to the 20/20 Step TDR are also applicable to the E20/20 Step TDR.

Section 4 – Trace Memory and Cable Lists

Introduction

This section of the operator manual covers operations in the Memory menu which includes:

- Saving Traces
- Recalling traces
- Deleting Traces
- Recalling traces to use as instrument setups
- Editing the Cable List on the TDR

For information on using ETDR PC Vision for uploading traces to the PC or uploading and down loading Cable Lists, refer to Section 5 ETDR PC Vision.

NOTE: The memories used to save traces and the Cable List are non-volatile type of memory devices. The loss of battery charge, changing batteries, etc. will not cause loss of any saved traces or cable types. However, it is prudent to upload traces and save modified cable lists to a PC as soon as practical to ensure 100% backup.

Saving and Recalling Traces

General

Traces saved in the TDR'S's memory can be recalled on the TDR's display or uploaded to a PC using ETDR PC Vision software. Once uploaded to a PC, they can be archived on the PC or other memory media. When a trace is saved it also saves all the TDR setups for the cable type tested, Range, Z Scale, and other TDR settings. When any trace is recalled on the TDR it will change the TDR's setups to the ones used when that trace was saved. This recalled setup can be used to continue testing. See Recalling Test Setups later in this section.

Saving Traces

Press the  key to access the memory functions shown in figure 4-1.

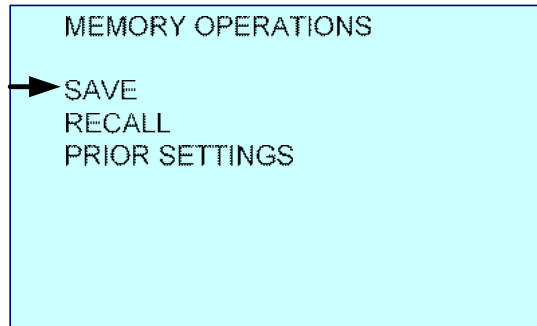

Figure 4-1

To save the current trace press the ► key at "SAVE" and the menu will guide you to enter a name for the trace as shown in figure 4-2.

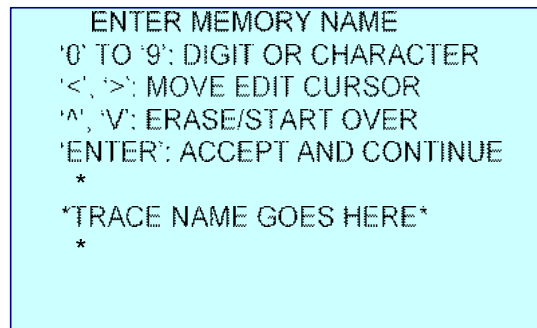

Figure 4-2

Use the alpha-numeric keypad to enter the trace name. Each key cycles when repeatedly pressed from the number to the next character shown above the key. When the desired character is entered (after a delay in pressing) the cursor will auto-advance one position to the right or press ► key to skip the cursor to the next digit position and repeat character entry until the trace name is completed. To delete the last character entered press the "Bcksp" key. To change a character entered use the ◀ key to reposition the character cursor (*) at the desired position.

NOTE: The |__| symbol above the "1" key is a space and the "0" key has more characters in its cycle than the "% & =" Full character set is: % & = - / + < > '



When the name is complete (11 characters maximum) press the **ENTER** key to save the trace with the name. The date and time will be saved automatically along with the cable's impedance, velocity, trace data and all the TDR's current setups. When the trace has been saved, the TDR will return to the Measurement Screen.

The maximum number of traces that can be saved is 32. Saving trace number 33 or more will overwrite the traces with the oldest date/time stamps. See Deleting Traces later in this section or ETDR PC Vision software instructions for deleting traces.

Recalling Traces



Press the **Memory** key to access the memory functions shown in Figure 4-1. Then use the **▼** key to move the menu cursor down to the "RECALL" and press the **▶** key to recall the memory trace list shown in figure 4-3.

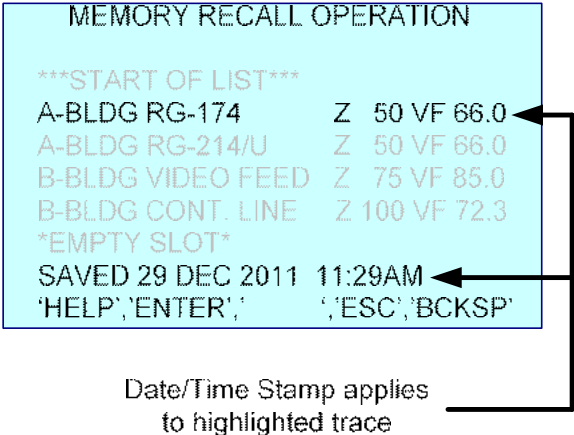

Figure 4-3

Use the **▲▼** keys to move the bold highlight to the desired trace. Use the **◀▶** keys to scroll the list up or down respectively one page at a time.

The "SAVED (date & time)" information at the bottom applies to the bold highlighted trace. Traces are saved in date/time order starting with the newest at the top of the list. Newest to oldest is determined by the date/time set in the TDR.

The available actions are shown at the bottom of the LCD as follows:



– Press to call a context sensitive help screen with directions about this screen’s available actions. Press Help a second time to return to this screen.



– Press to recall the highlighted trace. This action will return the TDR to the Measurement Screen with the selected trace as in the example shown in figure 4-4. “RECALL:” and the saved trace’s name indicates a saved trace is being displayed.

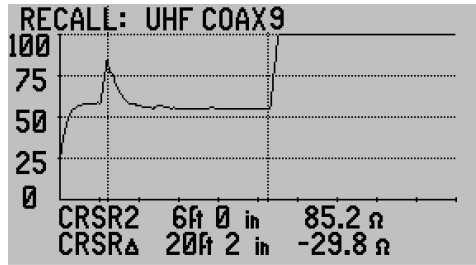

Figure 4-4

NOTE: The Zoom function is not available when viewing recalled traces.



– Press if no trace is being recalled. This will exit the Recall List and return to the previously used Measurement Screen.

Deleting Traces



– Press to delete the highlighted trace. The TDR will show one “Delete Confirmation” screen. If you are sure you want to delete the trace press



the ENTER key. If you are not sure about deleting the trace press the

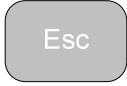

key to abort the deletion process.

NOTE: There is no “UNDELETE” feature in the TDR. Be sure saved traces have been uploaded to a PC and archived or are absolutely not required prior to deleting.

Traces stored in the TDR’S’s memory can also be selected and deleted using ETDR PC Vision software. Refer to Section 5.

Recalling Test Setups

Recalling a saved trace also recalls all the instrument setups used at the time the trace was saved. This includes the Cable Type, Z_0 , VF, Range, Z Scale, Cursors in use, and all Meter and Trace menu settings. This can be a fast way to reset the instrument to the cable type and setups used with the saved trace using the following steps:

1. First, recall the desired trace using the instructions in the Recall Trace section.
2. When the recalled trace is displayed on the Measurement Screen, press



the Esc key. This will change the top line of the LCD from the recalled trace name to the cable type, Z_0 , and VF used when the trace was saved.

Restore Prior Settings

When a trace is recalled from the memory, the TDR must be restored to the settings used at the time the trace was saved. If you desire to return to the original settings being used before one or more traces were recalled, press the



key to access the memory functions menu shown in Figure 4-5.

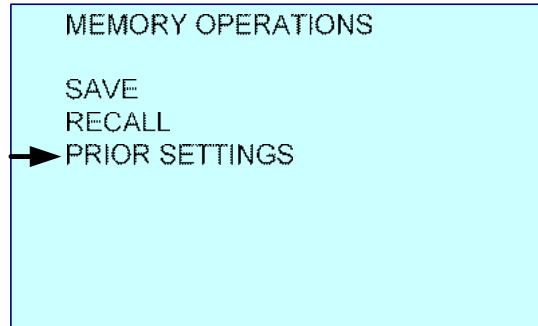

Figure 4-5

Then use the ▼ key to move the cursor down to “PRIOR SETTINGS” and press the ► key to restore the TDR’s settings. This includes the Cable Type, Z_0 , VF, Range, Z Scale, Cursors, and all Meter and Trace menu settings in use before recalling the traces from memory. The TDR will return to the Measurement Screen with all these setting restored.

Editing the Cable List

General

The TDR’S’s Cable List memory is capable of holding 64 cable types with their Impedance (Z_0) and Velocity Factor (VF). Each model of the TDR has a cable list stored at the factory that is aligned with the connectors and model ordered. Not all lists contain 64 cable types. Available storage is at the bottom of the lists marked by “OPEN n.” The n = number of remaining open slots. The factory default Models and Cable Lists are:

TDR Model	Part Number	Cable List
E20/20N TDR	6021-5000	Broadcast
E20/20F Network TDR	6021-5041	CATV
E20/20F Network TDR	6021-5042	Telco
E20/20B Network TDR	6021-5053	VDV/RF
Avionics TDR	6021-5054 or 5154	Avionics

There are two methods for modifying the Cable List:

1. Edit the list on the TDR by either modifying an existing cable or entering a new cable.
2. Upload and modify the TDR's Cable List in ETDR PC Vision software or download another factory default list, or a custom list as developed in ETDR PC Vision.

The remainder of this section of the Operating Manual will cover the first method. Section 5 will cover uploading, modifying, and downloading Cable Lists from the PC using ETDR PC Vision.

Edit Cable List Instructions

Press the  key to open the Cables menu as shown in figure 4-6.

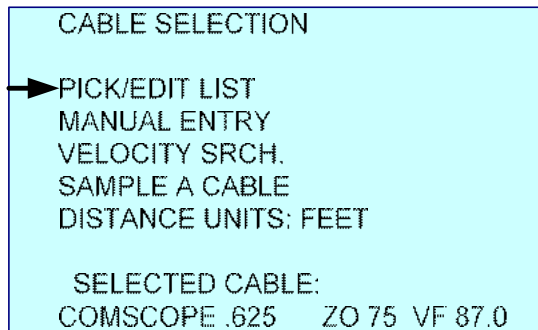

Figure 4-6

Press the **▶** key to select PICK/EDIT LIST. This will open the Cable List as shown in figure 4-7 (cables shown are for example only, lists vary with TDR models).

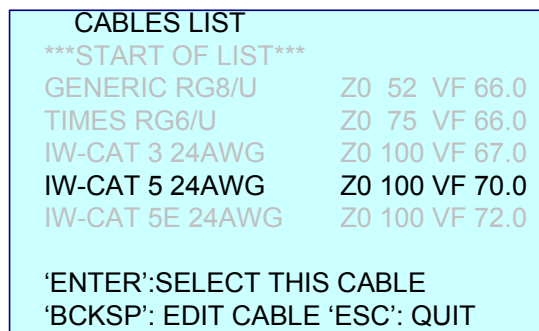

Figure 4-7

- OPTIONS:
1. Modify an existing cable on the list.
 2. Enter a new cable in an open memory slot (at end of list).

NOTE: If an existing cable is modified, it can not be recalled on the TDR as originally loaded. The change is permanent to this list unless you write down the

original cable's data and re-edit that cable. It can also be restored using ETDR PC Vision software. Refer to Section 5 for those instructions.

Use the ▲ ▼ keys to scroll up or down one cable at a time or the ◀ ▶ keys to scroll up or down one page at a time to reach the cable to be modified or and



open slot. Press the key to enter the Edit screens. The Edit screens will be presented in the following order:

ENTER Z0
ENTER VF
ENTER DESCRIPTION

Figure 4-8 is the ENTER Z0 screen.

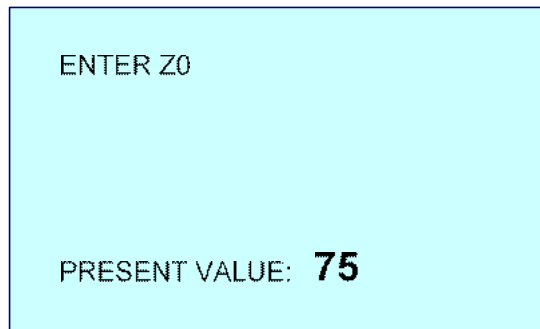

Figure 4-8

Use the alpha-numeric keypad to change the impedance value and press



to accept and move to the ENTER VELOCITY FACTOR screen shown in figure 4-9.

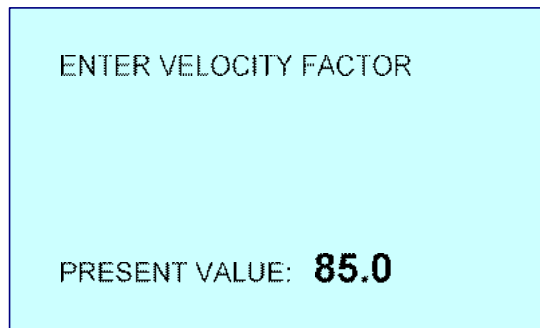

Figure 4-9

Use the alpha-numeric keypad to change the velocity factor value and press



to accept and move to the ENTER CABLE DESCRIPTION screen shown in figure 4-10.

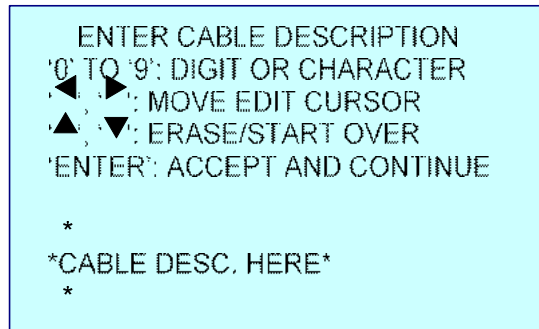

Figure 4-10

Use the alpha-numeric keypad to change the cable description (same actions



described earlier in this section for naming traces) and press to accept and move to the entry confirmation screen shown in figure 4-11.

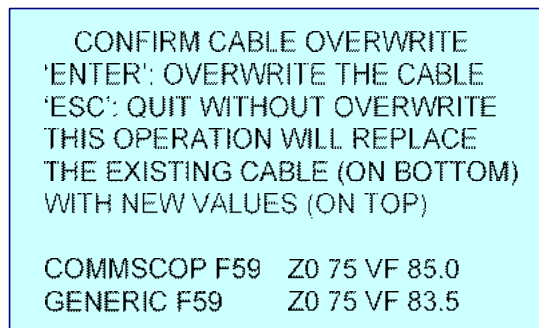
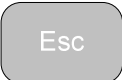



Figure 4-11

Pressing the  key at any of the above screens will leave the original value the same and continue on to the "Confirm Cable Overwrite" screen.

Pressing  in this screen will abort the change and return to the Cables menu.

The edited or new cable will now appear on the Cable List for selection and use as desired.

As a reminder – If you edit the TDR's Cable List in the field and wish to preserve that list, use ETDR PC Vision's Cable List tab to upload the TDR's list and save it on the PC under a user entered name.

Section 5 – ETDR PC Vision™ Software

Operating Systems

The ETDR PC Vision software included with the TDR is designed to operate on most PC's with the following operating systems:

Windows XP® – Home Office and Professional

Windows Vista®

Windows 7®, 8.0®, 8.1®, and 10®

NOTE: TDR PC Vision (for 20/20TDR models) and ETDR PC Vision (for E20/20 TDR and Avionics TDR models) can reside on the same PC. However, they must be used with their respective instrument models:

E20/20 TDR or Avionics TDR – Use ETDR PC Vision

20/20 TDR – Use TDR PC Vision

Installation

NOTE: Before installing a new or upgraded version of ETDR PC Vision software, be sure to use Windows Control Panel, then Windows 7 “Programs – Uninstall a Program” or Windows XP “Add or Remove” feature to remove any older version being replaced.

Using the CD – Use Windows Explorer® to access the removable media disk with the E20/20 TDR and Avionics TDR CD loaded. The CD has two applicable folders:

1. ETDR PC Vision, containing:
 - ETDR PC Vision software
 - ETDR PC Vision Setup.exe – Use this file to install the software
 - ETDR PC Vision “Readme” file – Contain useful information concerning installation and a list of changes when the software is upgraded.
2. FTDI Driver – The driver is required to support the USB/Serial communications protocol. It may already be loaded on your PC, in which case ETDR PC Vision will load and connect to your TDR without installation of the driver. Should you encounter an issue getting ETDR PC Vision to communicate with the TDR, we recommend installing the driver. See FTDI Diver Installation steps for the different operating systems at the end of this section.

From the enclosed CD - Open the folder “ETDR PC Vision” and double-click the “Setup” application. Follow the standard Windows installation guide until completed. When finished the ETDR PC Vision icon, figure 5-1 will appear on the desktop.

Downloading from AEA Technology's web site – Go to www.aeatechnology.com. In the tool bar at the top of the home page, position the mouse pointer on “Literature and Software” then click on “Software” in the drop down menu. Locate the “ETDR PC Vision” software and click on “Download.” Follow your operating system's instructions to save the downloaded file to a desired folder. When the download is complete, unzip the down loaded file and run the “Setup” application. Follow the standard Windows installation guide until completed. When finished the ETDR PC Vision icon, figure 5-1, will appear on the desktop.



Figure 5-1

Run ETDR PC Vision

There are two major modes of operating ETDR PC Vision; with or without the TDR connected. Here's a quick summary of the differences:

Working with TDR Connected (all functions available)

- COM Port tab functions for setting up TDR communications
- Uploading, working with and saving traces to the PC
- Printing, exporting, and saving traces
- Deleting traces in the TDR
- Uploading, editing, or downloading cable lists to the TDR
- Uploading or downloading TDR settings
- All PC only operations like recalling archived traces, opening, editing and resaving cable lists on the PC.

Working without TDR Connected (all PC only functions available)

- Opening archived traces and working with the graphs
- Printing, exporting or saving archived traces
- Opening, editing, and resaving cable lists on the PC

Working with the TDR connected

First, ensure the TDR is connected to the PC's USB port via the USB cable provided. The TDR needs to be powered on and at the Measurement Screen to communicate with the PC software. Next double-click the ETDR PC Vision icon on the desktop to open the application. With the first connection after the software is installed, ETDR PC Vision will not automatically connect to the TDR. Go to “Connection Error” sub-section on the next pages and follow those instructions to make the serial/USB ports connected on the PC. After the first connection ETDR PC Vision will connect automatically with the TDR and open to

the “Get Trace” tab shown in figure 5-2. During the connections process this window will show “Searching for TDR” and “Connecting to TDR” status updates.

Get Trace Tab



Figure 5-2

The “Plot Current Trace” and “Plot Archived Trace” buttons should be active (black font). If they are active skip the “Connection Error” instructions and continue with “Working with the TDR Connected” If “Plot Current Trace” is not active (blue font) ETDR PC Vision has failed to automatically locate the TDR and set up the USB to Serial Port connection. Select the “COM Port Utilities” tab and follow Connection Error instructions.

Connection Error – If ETDR PC Vision can not locate the TDR or if the TDR can not establish a COM Port connection link, go to the COM Port Utilities tab as shown in figure 5-3 which offer a list of suggested common issues to correct the connection.

If this is the first attempt to communicate with the TDR after loading ETDR PC Vision a communication error will occur and a COM Port will need to be selected. Additionally, you may need to load FTDI drivers to complete the process. Refer to “Installing FTDI Drivers” at the end of this section.

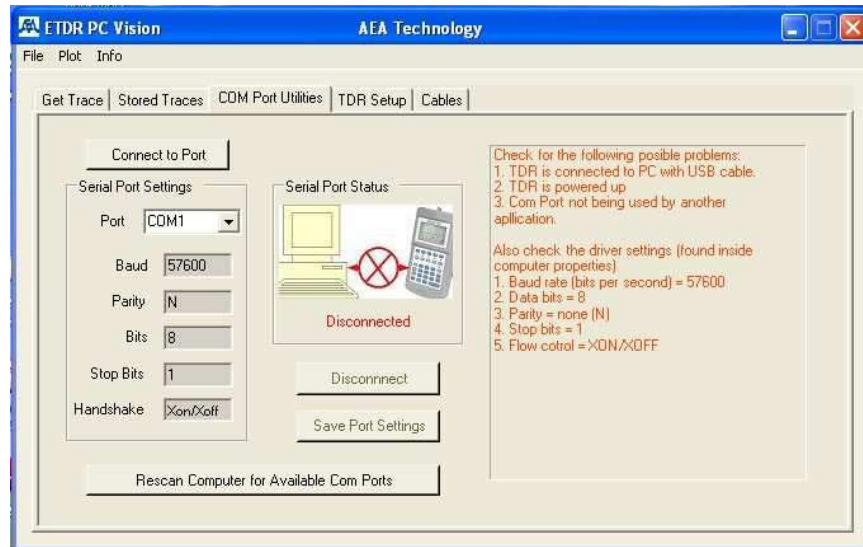

Figure 5-3

Check List to Establish Communications:

1. Ensure TDR is powered on and at the Measurement Screen.
2. Ensure the USB cable is connected between the PC and TDR.
3. If the “Disconnect” button is enabled, press to disconnect port attempt.
4. Press “Rescan Computer for Available COM Ports”
5. Ensure port (normally COM3 or higher) has the following settings:
 - a. Baud = 57600
 - b. Parity = N
 - c. Bits = 8
 - d. Stop Bits = 1
 - e. Handshake = Xon/Xoff
6. If any changes are made, press “Connect Port/Poll TDR” button.

Once communications is established between the TDR and the PC, the “Serial Port Status” block will look like figure 5-4.



Figure 5-4

NOTE: If you plan to connect multiple TDRs (one at a time at different times) to the same PC refer to “Preventing Auto Increment of the Serial Port When Using the AEA E2020 TDR USB Serial Interface” later in this section.

If the only work to be done with the TDR involves uploading current traces or archived traces, continue working with the “Get Trace” tab shown in Figure 5-2. For work with traces stored in the TDR’S’s memory click on the “Saved Traces” tab and skip to next sub-section “Saved Traces Tab” in this section of the manual.

NOTE: When uploading the current trace, the TDR does not know where the cable ends. It will only upload the presentation on the TDR’s LCD plot display. This provides the option to upload only a segment of interest on the cable or the entire length if the range is set beyond the cable’s end.

“Plot Current Trace” – Press to upload the current trace displayed in the TDR’S’s Measurement Screen.

“Plot Archived Trace” – This button will open a folder on the PC to select a previously stored trace or move to a folder or PC connected storage media for selecting a previously stored trace (TDR connection is optional with this action).

NOTE: Default Locations for data files supplied with ETDR PC Vision (or ... where did Windows put my files???)

Different versions of MS Windows[®] use different locations to install the Cable Tables and the demo archived trace files supplied with this software. Refer to this subject (as underlined) at the end of this section for the paths used by Windows XP[®], Vista[®], and Win7[®].

Stored Traces Tab

Refer to figure 5-5. With communications established between the PC and the TDR all the available functions in ETDR PC Vision's "Stored Traces" tab are available:

1. Upload and view a list of stored traces from the TDR
2. Upload or delete selected traces from the TDR's memory
3. Copy to Clipboard a list of the traces in the TDR's memory
4. Archive a selected group of stored traces or the entire list of stored traces to the PC.

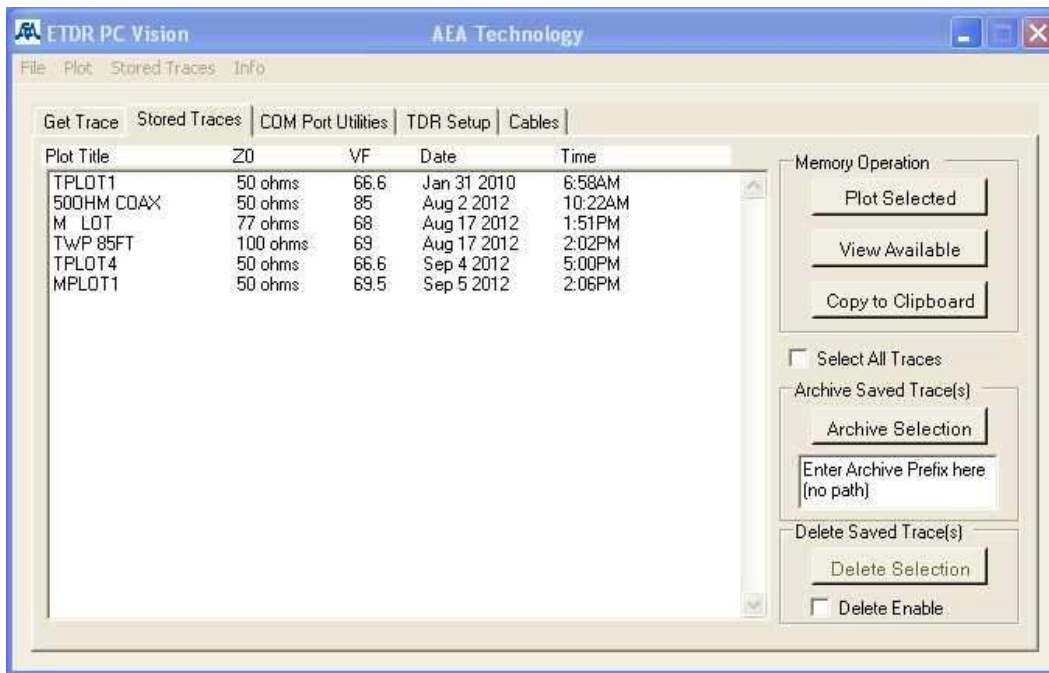

Figure 5-5

“View Available” – To view traces stored in the TDR'S's memory press this button first to upload and display the list of traces stored in the list area of this tab.

NOTE: The following actions can apply to one trace, multiple selected traces or all traces shown in the uploaded list of traces. Use the keyboard's "Shift" or "Ctrl" key with the mouse's left click to select the desired traces.

“Plot Selected” – This button will upload and display a graphical plot of the highlighted trace shown in the list. To learn more about the graphical plot and available user actions go to the “Open a Trace Plot” sub-section next in this section.

“Copy to Clipboard” – This button will send the uploaded trace list to Clipboard. Using Windows functions this list can then be printed, pasted to a document or saved.

“Archive Selection” – This feature is designed to directly archive traces highlighted on the uploaded list or to archive all the traces in the uploaded list. When a single trace is archived on the PC from the graphical plot, the trace, by default, takes the name of the plot uploaded or edited in the graphical plot. When archiving multiple traces directly from the TDR’s memory, ETDR PC Vision needs the user to input a traces’ group name, the trace’s stored name will be used, and it will automatically assign a numerical designator to each trace to avoid any duplications.

“Delete Selection” – This button will delete the highlighted trace or group of traces from the TDR’s memory. As a precaution against accidental deletions the “Delete Enable” box must be checked first to enable (Black text) this button.

CAUTION: THERE IS NO UN-DELETE FUNCTION. Be sure the trace(s) you plan to delete has/have been successfully uploaded and archived on the PC or other storage media, or is/are definitely not needed or they will be lost forever.

Open Trace Plot

When any trace is opened (“Plot Selected”), it will graphically plot on the screen similar to what is shown in figure 5-6. The graphed trace will contain either the 1920 data points if saved in feet or 2000 data points if saved in meters. Refer to appendix D for a table of LCD plot and ETDR PC Vision graph resolutions.

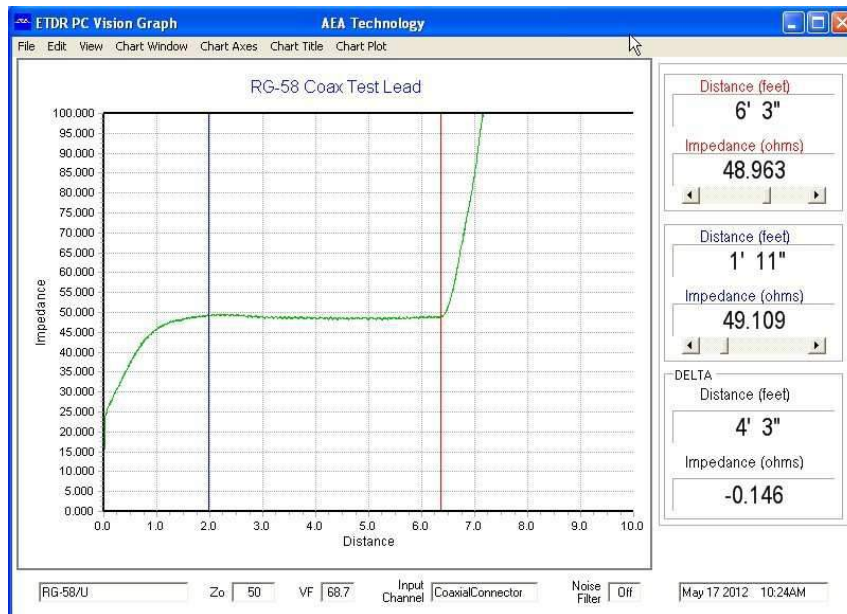

Figure 5-6

Chart Information

Graphic Plot – The graphic plot will open to a Z Scale and Range based on the plot information uploaded from the TDR'S's stored trace. See "Chart Axes" paragraph under "Plot Controls" to adjust the graph's scales. If the trace was saved in feet it will open the graph in feet. If the trace was saved in meters it will open the graph in meters.

Plot Title – This will be the name assigned at the time the trace was saved in the TDR's memory or in the case of uploading the Current Plot the assigned name "Live Plot n." n = number of Current Plots uploaded during this session with ETDR PC Vision. If characters were used in the stored trace's name that are not legal in Windows to use in a Saved Name, they will appear as blank underscores. This can be corrected by clicking on "Plot Title" in the tool bar to edit the plot's name or later when the Windows "SaveAs" sub-window appears.

Cursors – The graphical plot will have two color coded cursors available with their data, Distance and Impedance shown on the right side of the graph. The "DELTA" cursor is the difference reading between the red and blue cursors. If the trace was saved in feet it will show cursor distances in feet. If the trace was saved in meters it will show cursor distances in meters.

Bottom Line Data – Data shown below the graph is data saved at the time the trace was saved on the TDR and is uploaded as part of the trace's file. It can not be changed by the user in ETDR PC Vision. Data includes:

- Cable Type with Impedance (Z_0) and Velocity Factor (VF)
- Input channel used for the measurement
- Noise Filter – ON or OFF
- Date and Time the trace was saved

Plot Controls

Cursors – The red and blue cursors can be directly clicked on and dragged to a desired position on the graph, or use the red or blue cursor data window's slide bar, or fine positioned by using the control arrows. The "DELTA" cursor window indicates the difference in distance and impedance between the red and blue cursors.

Chart Zoom – To zoom in on any part of the trace, position the mouse at the upper left point of interest, click and hold the left mouse button and drag it to the lower right position of interest and release the mouse button. The trace will expand to the box created around the point of interest on the chart. To un-zoom, click and drag any rectangle's lower right corner to the upper left corner.

Chart Tool Bar

File – Similar to most Window’s File menus, see figure 5-7.



Figure 5-7

Archive – Opens two options:

1. Archive the current plot (graph and data) as it appears.
2. Open a previously archived plot

Export Graphics – Opens a sub menu to export the graphics as BMP, JPG, GIFF, or TIFF files.

Export Data – Opens a sub-menu to export the trace’s data points (1920 points for feet or 2000 points for meters) to either an Excel or Word in.xls file format. The trace’s data points each have a Point Index Number, Distance and Impedance data.

Print Graph only & Print Graph and Data – Data refers to the cursor information on the right side of the graph. These options will open a “Print Preview” or “Print” options.

Plot Compare – This feature permits selecting and opening a second plot from archives. The trace in that file will plot with the trace in the current graph in an alternative color to distinguish the two traces. A historical or “As Built” trace can now be compared with new trace to see if any changes have occurred in the cable over time.

Exit – Closes the plot

Edit – Copy the chart to clipboard.

View – Used to enlarge the graph portion of the plot by hiding the cursor values displayed on the right side. Default is “Cursor Values Displayed” click on “Maximize Plot” to enlarge the graph.

Chart Window – Has three options:

Control Background Color – Click to open a color palate to choose from.

Save Settings As... – Permits saving the chart settings to a file for later use.

Loading Settings... – Opens a file browser sub-window to select a previously saved chart setting.

Chart Axes – Opens a Chart size control sub-window to select/deselect Autoscale and manually rescale the chart. See figure 5-8.

Left Axis – Impedance Scale in Ohms

Bottom Axis – Range Scale in feet or meters (determined by uploaded trace)

AutoScale ON/OFF – When ON (check in box) The software will control the scale based on the traces data points. When OFF, user can specify the Minimum and Maximum Scale by entering values in those boxes for both the Ohms and Distance

To rescale the chart:

1. Turn OFF (uncheck) Autoscale for either the “Left Axis” or “Bottom Axis” or both.
2. Enter the Minimum and Maximum Values for the desired scales.
3. Press “Apply” to use the new scales and return to the graphical display.

NOTE: To maintain the manually set scales and apply these settings to other traces, open “Chart Window” and use the “Save Settings As” feature.

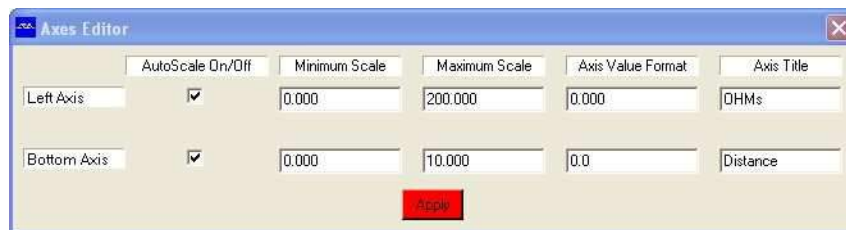

Figure 5-8

Chart Title – Rename the uploaded title and/or change title's color

NOTE: The title only permits characters legal to use by Windows in a saved trace name as this name will be the default name for archiving the trace. If an uploaded plot has invalid Windows naming characters they should be replaced before attempting to save the plot.

Chart Plot – The trace on the graph can show just the colored line (plot Color) connecting all the data points or the colored line and the data points as small black squares along the trace. “Tool Tip” can be turned on and set up for the mouse pointer to show plot point data (X=Distance, Y = Impedance, or both X and Y) when the mouse pointer is positioned on a plot point. Additionally, any impedance trace can also be viewed in “Micro Fault” modes. See figure 5-9.

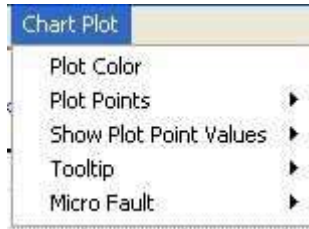

Figure 5-9

Plot Color – Click to open a sub-menu of colors to choose from for the trace's line color.

Plot Points – Turns ON or OFF the individual plot points as small black squares. Traces uploaded in feet will have 1920 plot points. Traces upload in meters will have 2000 plot points.

Show Plot Point Values – Turns ON or OFF the X value (Distance) and Y value Impedance. These values display on the graph near the plot point when "Tooltip" is ON and positioned over a plot point.

Tooltip – Turn ON or OFF

Micro Fault – OFF – Displays the trace as impedance

KINKS ONLY – Displays the trace with Z_0 at the bottom of the chart and enhanced impedance spikes for kinks or crushes in the cable that might be missed on the normal impedance trace.

ALL FAULTS – Displays the trace with limited Z Scale (impedance) and removes the loop resistance (dribble up) to keep the trace's Z_0 centered as much as possible to view any minor deviations.

TDR Setups Tab

The “TDR Setup” figure 5-10 is used to upload, edit, and download TDR setups to the TDR. The edited setups can be uploaded directly to the TDR or stored on the PC for later recall and upload.

NOTE: When this tab initially opens the values shown will be grey fonts indicating they are not current data or values set in the TDR. Press the “Read from TDR” key first to read the values from the TDR.

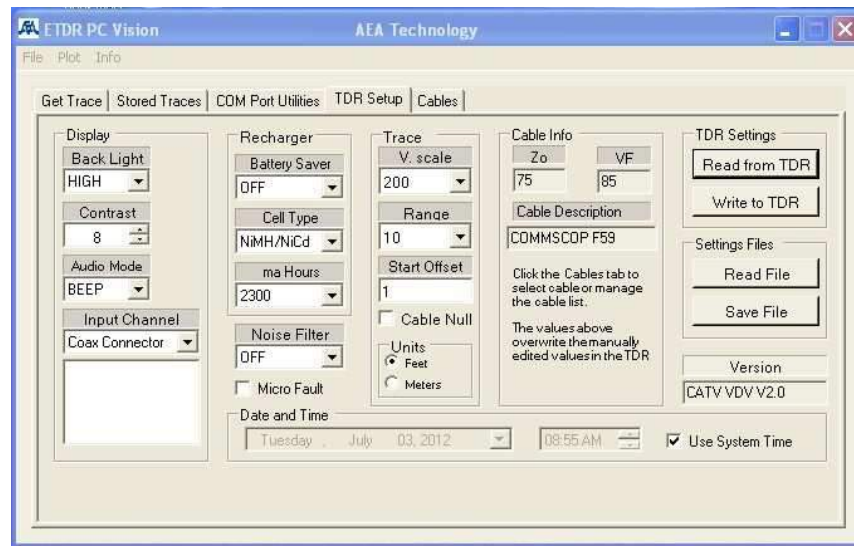

Figure 5-10

Read from TDR – Reads the current values set in the TDR and displays them in this tab. After an initial read the grey text fonts will turn to black text.

Write to TDR – Writes all the values set in this tab to the TDR. Values can be ones uploaded (no change) or altered values using either the parameter’s ▼ key to select set values from a pull down menu, check or uncheck associated box, or enter a value, as in “Start Offset”

Read File – Read and display in the tab the values previously saved to a file on the PC. This permits quickly resetting all the values in the tab from a previously saved tab setup.

Save File – Save all the displayed values to a file on the PC. Opens a standard Windows SaveAs sub-window to select a file name and location to save TDR Setups.

NOTE: Once a group of setups is downloaded to the TDR they can be saved in the TDR by saving a trace (cable attached is optional). At the TDR press “Memory” key and ► key at “Save,” name the trace, and press ENTER. All the

setups are saved along with the display plot whether a cable is attached or not. To recall and use this particular setup on the TDR press “Memory” and ► key at “Recall.” Use ▲▼ arrows to highlight the saved trace (setup) by name and press ENTER to recall. When the display recalls the trace all the saved setups used to save that trace will also be recalled. Press ESC to exit the “Recalled Trace” screen and return to the “Measurement” screen with the recalled setups.

Cables Tab

The “Cables Tab” permits uploading or downloading Cable Lists from the TDR, creating custom Cable Lists and saving them in a folder on the PC. Figure 5-11 shows the Cables Tab.

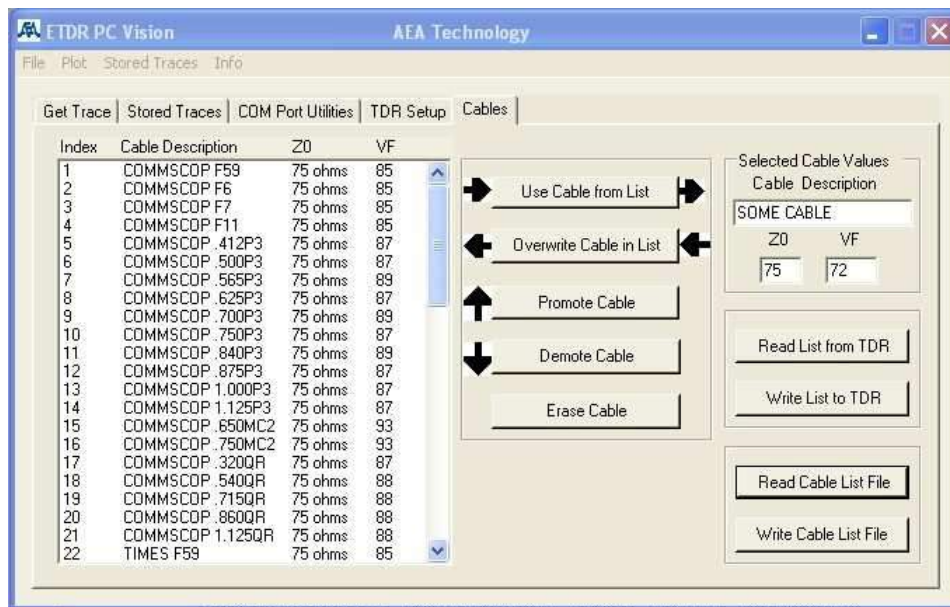

Figure 5-11

Read List from TDR – Uploads the Cable List stored in the TDR’s Cable List memory.

NOTE: When modifying cable lists it is recommended to re-save the modified list under a separate name from the original lists supplied with ETDR PC Vision. This will preserve the original cables lists for future reference.

Write List to TDR – Downloads the Cable List displayed in this tab to the TDR’s Cable List memory.

Read Cable List File – Opens a Windows standard “Open File” sub-window to load a saved Cable List file (.cbl extension) to the tab.

Write Cable List File - Opens a Windows standard “Save File” sub-window to save the Cable List shown in the tab.

Selected Cable Values – Use to enter the “Cable Description” (16 characters max), Z_0 (impedance) and VF (Velocity Factor, aka VP, VoP, or NVP) of a cable you desire to add or edit on the cable list.

Use Cable from List – Populates the “Selected Cable Values” with highlighted cable on the list.

Overwrite Cable in List – Replace the highlighted cable on the list with the “Selected Cable Values” displayed. To add a cable to the list, scroll through the list to look for “OPEN... $Z_0 = 33$ VF=33” or “OPEN n.” These are available cable memory slots. The latter will be at the bottom of the list and the “n” indicates how many open slots remain. Total slots for any one list is 64 as that is the maximum number of Cable List memory slots in the TDR.

CAUTION: There is no “UNDO” for this button. Make sure you no longer need the cable being overwritten or it is saved on another list on the PC for later retrieval.

Promote Cable – Moves the highlighted cable on the list up one slot in the order with each click on this button.

Demote Cable – Moves the highlighted cable on the list down one slot in the order with each click on this button.

NOTE: Promote and Demote do not delete or add cables only move their position on the list for faster access to more often used cables in the TDR.

Erase Cable – Deletes the highlighted cable and replaces it with “OPEN $Z_0 = 33$ VF=33” to indicate a user deleted cable slot available for saving a new cable.
SEE CAUTION ABOVE WITH “OVERWRITE CABLE IN LIST”

Working without the TDR Connected

Available actions: Get Plot Tab – “Plot Archived Trace”
 Open Trace Plot – All plot menus and features
 Cables Tab – “Read Cable List File”
 “Write Cable List File”
 All list edit actions

All the above actions work the same as with a TDR connected. Refer to the previous paragraphs on those tabs and the trace plot for information on using those features.

FTDI Driver Installation

FTDI Driver is located on the TDR'S's enclosed CD or can be downloaded from FTDI Chip at www.ftdichip.com/Drivers/VCP.htm.

NOTE: This one driver works for Windows versions 7, 8.0, 8.1, and 10. Windows XP and Vista are no longer supported by FTDI Drivers.

NOTE: When the driver is downloaded from FTDI Chip, Windows 7 and 10 may perform an automatic installation on your PC. If this occurs you will see pop up window indicating they were installed. You can skip all the following steps, return to desktop and double-click the ETDR PC Vision icon to start over. Then refer back to "Check List to Establish Communication" earlier in this section.

Windows 7

Windows 7's initial "New Device Detected" may not offer the option to browse your PC or a CD and the FTDI device drivers supplied by AEA Technology. Recommend the following steps to install the FTDI Device Drivers from the AEA Technology CD:

Step 1 – Close ETDR PC Vision software and disconnect the TDR from the PC.

Step 2 – Be sure the E20/20 TDR and Avionics TDR CD is inserted in the CD drive.

Step 3 – Power on the E20/20 TDR and connect it to the PC. If Windows offers "New Device Detected" options select install from CD or file." If it does not offer these option go to step 4.

Step 4 – Open Windows Help and type in "Update Device Drivers"

Step 5 – Click on "To download and update a driver yourself"

Step 6 – Click on "Click to open Device Manager"

Step 7 – Click on "Universal Serial Bus Controllers"

Step 8 – Click on "USB Serial Converter"

Step 9 – Open the "Driver" tab

Step 10 – Click on "Update Driver" button

Step 11– Click on "Browse my computer for driver software"

Step 12– Use the browse feature to go to the CD drive "FTDI Drivers" or file with FTDI Drivers download saved, check "Included sub-folders" and click on "Next" and follow the installation instructions.

Step 13 - When the device driver installation is complete return to desktop and double-click the ETDR PC Vision icon to start over and refer back to "Check List to Establish Communication" earlier in this section.

For Windows 8.0, 8.1 and 10 versions refer to the Windows Help for specific installation instructions.

Preventing Auto Increment of the Serial Port When Using the TDR USB Serial Interface

Introduction

Each USB serial port interface chip inside the TDRs contains their own unique serial number. The FTDI drivers used in the TDR assign a serial port to the device (TDR) based on this serial number. If two or more TDRs are plugged into a PC, the PC will assign a different COMnn port assignments to each TDR. If you disable this feature, you can plug in different TDRs (one at a time) and always find those TDRs on the same COM port. Disabling the auto increment makes it easier to start the ETDR PC Vision software because any E2020 TDR automatically connects using the (same) default COM port that had been previously established.

Overview

A registry key will need to be added using the Windows regedit program. This key tells the system to ignore the serial number in the FDTI driver IC. Once completed, all E2020 TDRs connect (one at a time) to the same COMnn Port.

Once completed, multiple TDRs can be used, and the second one will be assigned a new COM port. This COMnn port assignment “sticks” to the cable so long as the cable is not moved to different USB port on the computer.

Modifying the registry affects all devices that use the FDTI USB-serial Chip, not just the E2020 TDRs. Chances are, if you are considering this registry modification, you are performing some depot level maintenance on E2020 TDRs. You may have to start up various application software for the other equipment using the FTDI driver and reassign COM ports. Once done, you should label the USB cables (TDR, Voltmeter, etc) and not move those cables to different USB ports.

Procedure

Be careful when modifying the registry, the PC will not boot if the registry is “bad”. Windows will allow you to revert to the previous registry if the edited one should fail.

This procedure details the steps to take using the regedit program in Windows XP. Other versions of Windows will be similar to this:

1. Start regedit: Click “start”, “Run...” type “regedit” into the text box, and click “OK”

2. Locate the folder “HKEY_LOCAL_MACHINE” and expand it (click on its + square). You may wish to collapse all folders first to make it easier to locate the folders of interest.
3. Under the HKEY_LOCAL_MACHINE folder find and expand the “SYSTEM” folder
4. Under the SYSTEM folder find and expand the “CurrentControlSet” folder
5. Under the “CurrentControlSet” folder find and expand the “Control” folder
6. Under the Control folder find and highlight the “UsbFlags” folder
7. With the “UsbFlag”’s folder highlighted, right click and select New | Binary Value
8. Highlight the new item, usually “New Value #1”, right click and then click “Rename”
9. Type or paste in the name ”IgnoreHWSerNum04036001” without the quotes
10. Right click IgnoreHWSerNum04036001 and choose “Modify Binary Data”
11. Add the 2 digits “01” (without quotes) to the dialog box and click “OK”. Ignore what’s already in the dialog box, just add the 2 digits. The results will resemble the display in figure 5-12.

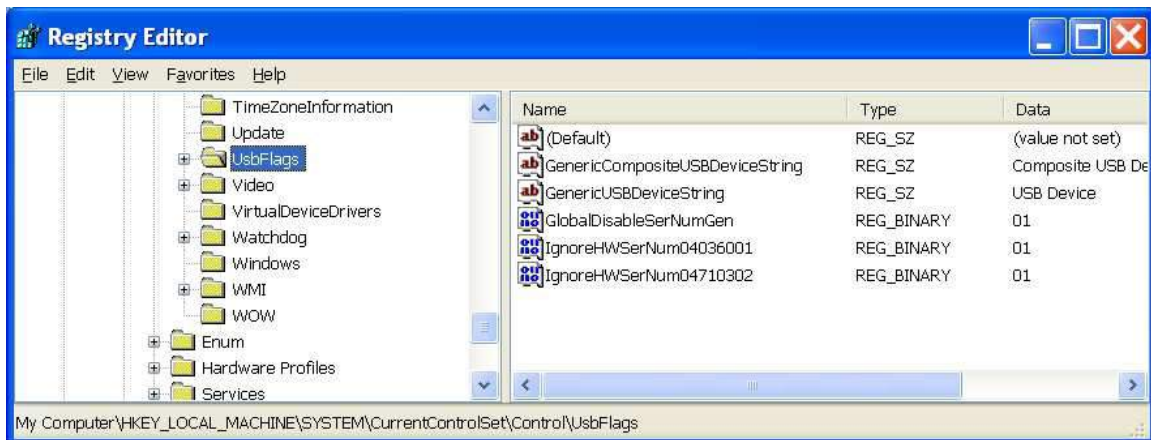

Figure 5-12

12. Click File | Exit to save the results. If you do not wish to save, click on the red X in the upper right.
13. Reboot the computer

Choosing a different COM port

If a different COM port assignment is desired, manually reassign the COM port. This reassignment will remain in place after rebooting the PC. The directions to find the device drivers are slightly different for Win7 and Vista, but the procedure is similar.

1. Power up the TDR
2. Connect the TDR to the PC with the USB cable.
3. Right click on “My Computer” and click on “Properties”.
4. Click the “Hardware” tab
5. Click the “Device Drivers” button
6. Expand the “Ports” icon
7. Locate which port the TDR connects to (verify this by unplugging the USB cable from the TDR, then reconnect it)
8. Double click the icon for the TDR COM port
9. Click the “Port Settings” tab.
10. Click the “Advanced...” Button
11. Select the desired COM port. Many of the COM ports may show as “in use”. If the COM port is NOT connected to a device in use, you may choose it as your new COM port. Many times the COM ports marked as “in use” are really idle, but have been allocated to a TDR with a specific serial number. Since we now ignore the serial number, any of these previously assigned COM ports are available for use.

Default Locations for data files supplied with ETDR PC Vision (or ... where did Windows put my files???)

Different versions of MS Windows® use different locations to install the Cable Tables and the demo archived trace files supplied with this software. Below are the paths used by Windows XP®, Vista®, and Win7®. Some of the folder names may be defined by the user or administrator.

Once you have navigated to where these files are located on you PC's hard drive and perform “open” or “save” a file there, PC Vision will remember that location. ETDR PC Vision will default to that location for future file open/save operations.

If you choose to save your data in a different folder, just copy the demo files (*.cbl and *.aea files) that came with ETDR PC Vision to your desired folder. Once you navigate to your chosen folder and save or open a file, that folder becomes the new default location for ETDR PC Vision file operations.

Windows XP

Starting at the C: Drive
C:\Documents and Settings\

Windows Vista

Starting at the “Vista” folder
C:\Users\Vista\

{folder with user name}\
Application Data\AEA Technology\
ETDR Data\

AppData\Roaming\
AEA Technology\ETDR Data\

Windows 7

Starting at your personal folder
C:\Users\{personal folder name}\
AppData\Roaming\AEA Technology\
ETDR Data\

ETDR PC Vision Software Updates

Software is a dynamic product constantly subject to improvement and additional features. AEA Technology, Inc. posts its latest versions on our web site at www.aeatechnology.com. Click on “Literature and Software” in the tool bar at the top of the site’s pages to locate “ETDR PC Vision Ver 2012.n.” The newer versions of ETDR PC Vision are compatible with older TDR’Ss and data files saved with an earlier version of ETDR PC Vision.

NOTE: Before installing a new or upgraded version of ETDR PC Vision software, be sure to use Windows Control Panel, then “Programs – Uninstall a Program” or “Add or Remove” feature to remove the older version being replaced.

ETDR PC Vision “Readme” files are included with every version change on either the CD or as part of the download. Please take a few minutes to read this file concerning the changes in the version.

NOTE: TDR PC Vision (for 20/20TDR models) and ETDR PC Vision (for E20/20 TDR and Avionics TDR models) can reside on the same PC. However, they must be used with their respective instrument models:

E20/20 TDR and Avionics TDR – Use ETDR PC Vision
20/20 TDR – Use TDR PC Vision

Technical Support

See Section 6 of this manual contains maintenance information and troubleshooting tables for the TDR’s operation and battery charging. Most issues can be solved by following the guidance in these tables.

Technical Support for all AEA Technology, Inc. products is available M-F, 7:30am to 4:30pm Pacific Time.

Tel: 800-258-7805 or +1-760-931-8979
Fax: +1-760-931-8969
Email: techsupport@aeatechnology.com

This page intentionally left blank

Section 6 – Warranty, Troubleshooting Guide, Maintenance, and Service Returns

Limited Warranty

AEA Technology, Inc., warrants to the original purchaser that the E20/20 TDR or Avionics TDR shall be free from defects in material or workmanship for a period of one year from the date of shipment. All units returned to the factory, delivery charges prepaid, and deemed defective under this warranty, will be replaced or repaired at this company's option. No other warranties are implied, nor will responsibility for operation of this instrument be assumed by AEA Technology, Inc.

There are no warranties that extend beyond express warranties stated herein. No other warranties are expressed or implied. AEA TECHNOLOGY SPECIFICALLY DISCLAIMS ALL IMPLIED WARRANTIES, INCLUDING THE IMPLIED WARRANTIES OF MERCHANTABILITY AND FITNESS FOR A PARTICULAR PURPOSE. THE REMEDIES PROVIDED HEREIN ARE BUYER'S SOLE AND EXCLUSIVE REMEDIES. AEA TECHNOLOGY, INC. SHALL NOT BE LIABLE FOR ANY DIRECT, INDIRECT, SPECIAL, INCIDENTAL, OR CONSEQUENTIAL DAMAGES, WHETHER BASED ON CONTRACT, TORT, OR ANY OTHER LEGAL THEORY.

Remedies for any breach of warranty, either expressed or implied, are limited to repair, replacement, or return of the instrument, at the option of AEA Technology, Inc. Any warranty is valid for the original purchaser only.

All warranties of performance are disclaimed.

AEA Technology assumes no liability for applications assistance or customer product design.

Operating Precautions

Although the TDR is a rugged instrument, care should be taken to avoid exposing it to excessive external RF, AC or DC voltage (either from a nearby transmitting site or from your own installation).

Before attaching the TDR to a cable leading to an antenna, it's a good practice to briefly ground the feed line in order to shunt any accumulated static charge to ground.

NOTE: The TDR is listed as explosion proof, but static discharge from the cable can NOT be prevented. Ensure no power or static is on the cable before connection in an explosive atmosphere.

External DC Power

If you wish to power the TDR from an external DC source (other than the AEA Technology's wall adapter), ensure it meets the following requirements:

- 2.1 mm (+) center pin DC power connector.
- Minimum 12 VDC (650 ma)
- Nominal 13.6VDC (550ma)
- Maximum 20VDC (550 ma)

- Notes: 1. Quarter VGA Display performance is impaired when input is below 12VDC.
2. Positive polarity must be applied to the center pin of the power jack for proper operation.

Batteries

For optimal performance in the field, the TDR should be powered by eight "AA" NiMH or alternatively alkaline batteries. If the TDR is to be stored for more than 30 days, the batteries should be removed. Battery leakage can seriously damage the TDR'S's battery compartment and other circuits. Damage from battery leakage is not a factory workmanship issue and therefore not covered under warranty.

Cleaning

The TDR is designed to operate in a variety of conditions and dirty environments. Cleaning on regular basis should be accomplished with a soft, water moistened cloth. If dirt must be removed, use a mild detergent sprayed on the cloth first. Do NOT spray detergents or water directly on the instrument. Avoid using solvents or ammonia based glass cleaners that can discolor the LCD protective cover and that may attack the plastic case or test lead insulation. Use orange based liquid or gel cleaner on a clean soft rag to remove cable gel from the instrument, test leads or carrying case.

The soft case should be cleaned in the same manner as the instrument, but a soft brush will help remove dirt, grime or cable gel. Always remove the carrying case from the instrument first. Washing in a machine or total immersion in soap and water is NOT recommended. Drying in a clothes drier or oven is also NOT recommended. Dry overnight on a clean cloth in fresh warm air.

The following are recommended cleaning agents for specific contamination:

Soil or light oily soil marks	Household glass cleaner (non-ammonia based) or 409 [®] cleaner
Cable gel	Orange based gel or liquid cleaner non-abrasive
Tar, creosote or sticky adhesives	WD40 [®] followed with household cleaner

NOTE: Always spray cleaners and rinse water on the cloth NOT the instrument.

Wiping dry with a soft lint free cloth will improve appearance over air drying.

Contact Us

If you have any questions concerning instrument maintenance, cleaning or care, please contact AEA Technology at 1-800-258-7805 M-F 7:00am – 4:30pm PST or by email at techsupport@aeatechnology.com.

TDR Troubleshooting Guide

Symptom	Possible Causes	Solutions
On power up, relays may click, but there is no visible display	Display contrast setting is not in line with temperature	Adjust contrast with blank screen - Press "Meter" key, press ▲ 6 times, press ▼ once, press ► repeatedly until text appears. Alternative – Perform a Soft Reset (Operator Manual, Section 1)
On power up, no relays click & no display appears	Power source or batteries at fault	Try a second power source. If on batteries use AC or DC adapter. If on AC use different outlet. If on DC turn on vehicle. Lastly, install 8 AA fresh batteries.
On power up, display appears, but there is no activity.	Illegal instrument state	Turn off and perform a Soft Reset (Operator Manual, Section 1).
TDR has large offset distance	Start Distance setting or "Test Lead Null." is ON or both	Press "Trace" key & reset Start Distance to 0 and/or turn OFF Test Lead Null.
TDR distance readings are in error	1. Cable Null is on 2. Wrong cable type or VF selected.	1. Press "Trace" key and turn off Cable Null. 2. Press "Cables" key to pick matching cable type or "Velocity Srch." or "Sample Cable" to find correct VF
Tone Function has AC noise over tone frequencies	AC adapter power in use	Operate the TDR Tone Function on battery power only to eliminate AC interference
TDR will not turn off	Illegal instrument state	Press and hold the ON/OFF key for about 10 seconds (Hard Power Down), then perform a Soft Reset with power ON (Operator Manual, Section 1)
TDR has steady beep tone and will not respond to any key press	Illegal instrument state	Press and hold the ON/OFF key for 10 seconds to perform a Hard Power Down and turn on using Soft Reset

ETDR PC Vision Software Troubleshooting Guide

Symptom	Possible Cause(s)	Correction
TDR and PC show "Disconnected" in "Connection Status"	<ol style="list-style-type: none"> 1. TDR is OFF or not in Measurement Screen. 2. USB Cable not connected 3. PC setups are incorrect 	<ol style="list-style-type: none"> 1. Turn TDR ON to Measurement Screen and try again. 2. Recheck USB cable connections 3. See Section 5 for COM Port Utilities corrective actions.
"Get Trace" tab only has "Plot Archived Trace" button active	ETDR PC Vision has not opened communications with the connected TDR or no TDR is connected	Select "COM Port Utilities" tab, re-scan for COM ports and connect or perform other recommended actions.
No COM port number or COM port number does not connect with the TDR.	PC may not have FTDI Drivers installed	Refer to Section 5, FTDI Driver installation. Drivers are on the enclosed CD or can be downloaded on the web.
Get Traces tab only has "Plot Archive Trace" button active	No TDR connected or TDR is not recognized	Normal for working with Archived Traces only, or check items shown above to connect to the TDR
Can't find archived TDR plots or cable lists	Windows reverts to the last folder referenced for opening or saving files.	Refer to Section 5, Where Did My Files Go for instructions on locating saved plots or cable lists

Power/Battery Charging Troubleshooting Guide

Symptom	Possible Cause(s)	Correction
External power is applied, but Status is always IDLE or stuck in BATT CHK (Some of these symptoms are more likely to occur when a new set of batteries are installed)	<ol style="list-style-type: none"> 1. Battery Type: NONE or ALKALINE previously selected. 2. Batteries may be damaged, defective, missing, improperly installed or have expired shelf life. 3. Contacts may be dirty or corroded. 4. External power may not be properly connected. 5. Non-AEA recommended power pack. 6. Cells may be alkaline or carbon. 7. Deeply depleted cells may take longer to condition. 	<ol style="list-style-type: none"> 1. Set Battery Type and Battery Capacity to match cell type. 2. Replace with new set of batteries or install cells per polarity guides. 3. Clean or replace contacts. 4. Check external power (wall switch off, bad plug, broken cord, etc.). 5. Use correct power pack. 6. Set battery type to ALKALINE. 7. Have patience, recheck status in one hour.
Operational time is getting shorter with each use.	Cells may be at or near mfg limit for number of recharges (nominal 750 times).	Lengthen recharge time, if no improvement replace cells with 8 new AA rechargeable cells
Not very old cells stop recharging	1. Battery Type: NONE or ALKALINE selected.	1. Set Battery Type and Battery Capacity to match cell type.

	<ol style="list-style-type: none"> 2. Charging power is not sufficient or not on. 3. Battery Temperature too HOT or COLD. 4. One or more cells is installed with polarity reversed. 5. Batteries are damaged, missing, or have dirty contacts. 	<ol style="list-style-type: none"> 2. Correct AC or DC input to TDR. 3. Recharge at room temperature. 4. Align all cells polarity per battery case Diagram. 5. Examine batteries and contacts correct any issues.
TDR auto powers down when batteries still workable	<ol style="list-style-type: none"> 1. Battery Save mode is ON. 2. By design to protect the cells & TDR from damage by operating at too low voltage. 	<ol style="list-style-type: none"> 1. See Battery Menu in the Meter menu. 2. Operate on external power, recharge the cells or change to fresh cells.
Charger goes directly to IDLE or TRICKLE	Cells may already be fully charged	Use battery power only & check Battery Status for full charge (>11v).
Charger Status jumps from BATT CHK to IDLE	<ol style="list-style-type: none"> 1. Cells may be missing, damaged or Defective. 2. One or more cells is installed with polarity Reversed. 	<ol style="list-style-type: none"> 1. Replace with new set of batteries. 2. Align all cells polarity per battery case Diagram.

Specifications

Specifications for the E20/20 TDR /Avionics TDR are contained in Appendix A.

Accessories

Accessories for the E20/20 TDR/Avionics TDR are contained in Appendix C

Instrument Return Instructions

Contact Us

If you have any questions concerning instrument maintenance, cleaning, care, or before making any return, warranty or out-of-warranty for an operational issue, material defect, or routine calibration, please contact AEA Technology first. Our trained staff can and do resolve most issues and get our customers operating again over the phone or by email.

Please contact AEA Technology at 1-800-258-7805 US & Canada or +1-760-931-8979, M-F 7:00am – 4:30pm Pacific Time or by email at techsupport@aeatechnology.com.

Return Material Authorization (RMA) Number

If after contacting AEA Technology's Technical Support it is determined your instrument needs to return to calibration or repair, we need to issue an RMA

number to include on the package addressing. The RMA number will tell everyone at AEA Technology handling your instrument exactly what to do, who to contact about repair costs, and who to return the instrument to when repairs are completed. It makes the entire process go smoothly and efficiently.

Be sure to include your RMA number with the return address (shown on the back of this manual).

Appendix A

E20/20 TDR Specifications

Characteristic	AEA Technology E20/20 TDR and Avionics TDR Specifications
Distance	
Range	0-13,250ft (3,300m) @ VF =.660c 0-20,000ft (5,000m) @ VF =.999c
Resolution: TDR in feet = ETDR PC Vision in feet = TDR in meters = ETDR PC Vision in meters =	span/240 or 1/2 in @ 10ft span span/1920 or 1/16 in @ 10ft span span/250 or 8mm @ 2m span Span/2000 or 1mm @ 2m span
Accuracy	<0.2% ± 1 inch (2.54cm) + VF uncertainty
Impedance (Z)	
Full Range	0 to 1K Ohms
Range Scales	20, 50, 100, 200, 500, and 1KOhms
Resolution	0.1 Ohms
Accuracy	<3% of reading may vary over longer lengths
Velocity Factor (VF)	
Range	0.20 - 0.999c
Resolution	0.001c
Dead Zone	
	None - Soft Z readings ≤2-4 ft (0.6 to 1.2 m) cable impedance dependent
Output Impedance	
	95Ω All Connectors
Pulses	
Amplitude	750mV ±50mV (open circuit)
Width	11.5 μsec Nominal
Repetition Rate	23 μsec Nominal (43KHz)
Pulse Rise Time	<1 nsec
Display	
Type	Qtr VGA LCD, Backlit
Size	287 X 156 pixel, 2.8 X 1.45 inch (67 X 37.5mm)

Characteristic	AEA Technology E20/20 TDR and Avionics TDR Specification
Display Plots	
Impedance Scales	Zo ± 10 , ± 25 , ± 50 , ± 100 , and 0-200, 500, or 999 Ohms
Range Scales: Feet Meters	0-10, 20, 50, 100, 200, 500, 1,000, 2,000, 5,000, 10,000, and 20,000ft 0-2, 5, 10, 20, 50, 100, 200, 500, 1,000, 2,000, and 5,000m
Cursors	2 with independent distance and Impedance, plus delta data
Zoom	Adjustable zoom ranges on active cursor
Noise Filtering	ON/OFF
Input Protection	
Continues Operation	1.0VAC Pk-to-Pk, or 50VDC
High Voltage Warning	Over 1.0VAC Pk-toPk, 50VDC
Protection Limit	250VAC or VDC
Advanced Features	
Micro Fault Detection: Kinks Only – All Faults –	Locates coax crimps or crushes too small for easy detection on impedance trace Enhances any faults on any cable type, removes dribble up (DC loop resistance) for flatter trace
Cable Sampler	Computes VF on sample length
VF Search	User adjust VF to known event or cable end
Test Lead Null	Removes lead from measurement
Start Distance Off Set	Adjust trace's start distance to improve resolution in range scales
Cable Trace Tones (Hz)	900/1100 warble, & 977.5, 850, 577, and Pocket Toner DC voltages All steady or pulse selectable
Setup Wizard	Guides user through set ups
Context Sensitive Help	For any action key or menu item
Smart Charger settings	Use NiMH, NICD, Alkaline cells, 400-5000mAh rated.
Real Time Clock	Date/time stamps saved traces
Cable List	
	64 programmed cables, user select, edit and overwrite. ETDR PC Vision can upload or download revised lists.
Memory	
	32 Display Traces/ Instrument setups with trace name and date time stamp

Characteristic	AEA Technology E20/20 TDR and Avionics TDR Specification
Trace Export	USB-Serial. AEA supplied PC software and USB Cable included
PC Software	"ETDR PC Vision" software included for trace upload, storing, printing & export. Cable List management & download, Memory Catalog management, and setups download
Power	
Batteries	8AA NiMH, NiCd or Alkaline cells. Internal charging. NiMH cells included.
Battery Operating	Alkaline Cells - 7 hrs top brands, NiMH & NiCd ~7.3 hrs on a full charge, Backlight use will reduce operating time
AC Power	100-240VAC, 50-60 Hz
DC Power	13.2 VDC minimum
Physical	
Size	8.5" (216mm) x 4.3" (109mm) x 2.25" (57mm)
Weight	2.2lbs (1Kg) with batteries & belt case
Environmental	
Operating Temperatures	-18° to 50°C (0° to 122°F)*
Non-operating Temperatures	-30° to 70°C (-21° to 158°F)
Relative Humidity	0-95% non-condensating
Weather	rain & dust resistant
Drop Resistance	MilSTD 810G, Procedure IV Transit Drop 48inches (122cm), 26 drops
Explosion Proof	MilSTD 810G 511.5, Procedure 1
EMI Shielding	Avionics TDRs only MilSTD 461F Emissions and Susceptibility
*Refer to the Operators Manual Appendix E for extreme cold weather operations	

Characteristic	Avionics TDR Kit's Hard Case
	Specifications
FOD Protection	Custom foam for item securing and lid label for item ID and locating
Transportation	ATA 300, Category 1 rated
Size	18.1 x 13.7 x 6.9 inches (48 x 35 x 18cm)
Weight	11.5lbs (5.2Kg) with TDR and all accessories
Environmental: Ambient Pressure Equalization Waterproof & Dust Tight Impact, UV, Solvents and Fungus Resistance	MilSTD 648C MilSTD C4150J MilSTD 810F for all

Appendix B

RJ-45 Input Channel Translation Table to Cable Pairs, Pins and Wires

Authority	Wire Map Scheme	Jack/Plug	Wiring Color Code	20/20 TDR
		Pins		Input Channel
AEA	Coaxial Connector	Coaxial	Alternative Red/Black Lead	COAX
Technology	Red/Black Clips	4 & 5	N/A	RJ45 CH A
Accessories	Green/Black Clips	3 & 6	N/A	RJ45 CH B
TIA/EIA 568A	T-568A Pair 1	4 & 5	Blue/White	RJ45 CH A
	T-568A Pair 2	3 & 6	White/Orange	RJ45 CH B
	T-568A Pair 3	1 & 2	White/Green	RJ45 CH C
	T-568A Pair 4	7 & 8	White/Brown	RJ45 CH D
TIA/EIA 568B	T-568B Pair 1	4 & 5	Blue/White	RJ45 CH A
	T-568B Pair 2	3 & 6	White/Green	RJ45 CH C
	T-568B Pair 3	1 & 2	White/Orange	RJ45 CH B
	T-568B Pair 4	7 & 8	White/Brown	RJ45 CH D
Telcordia	USOC RJ45 Pair 1	4 & 5	Blue/White	RJ45 CH A
(Telco)	USOC RJ45 Pair 2	3 & 6	White/Orange	RJ45 CH B
	USOC RJ45 Pair 3	2 & 7	White/Green	See Note 1
	USOC RJ45 Pair 4	1 & 8	White/Brown	See Note 1
Telcordia	USOC RJ11 Pair 1	2 & 3	Red/Green	RJ45 CH A
(Telco)	USOC RJ11 Pair 2	1 & 4	Black/Yellow	RJ45 CH B
Telcordia	USOC RJ12 Pair 1	3 & 4	Blue/White	RJ45 CH A
(Telco)	USOC RJ12 Pair 2	2 & 5	White/Orange	RJ45 CH B
	USOC RJ12 Pair 3	1 & 6	White/Green	See Note 1
Telcordia	USOC RJ12 Pair 1	3 & 4	Red/Green	RJ45 CH A
(Telco	USOC RJ12 Pair 2	2 & 5	Black/Yellow	RJ45 CH B
Alternative)	USOC RJ12 Pair 3	1 & 6	White/Blue	See Note 1

NOTES: 1. USOC pairs 3 & 4 require a special adapter not supplied with the TDRs. If you require assistance connecting to those pairs or other structured wiring systems not listed here, please contact AEA Technology for technical support.

2. RJ11 and RJ12 plugs do not always make perfect contact in an RJ45 jack. Use care when aligning that connection or use an adapter plug/jack.

Appendix C

See models pictured below for correct identification with accessory lists on following pages.

- E20/20N TDR – part number: 6021-5000**
- E20/20F Network TDR CATV – part number: 6021-5041**
- E20/20F Network TDR Telco – part number: 6021-5042**
- E20/20B Network TDR VDV/RF – part number: 6021-5053**



Avionics TDR – part number: 6021-5054



Avionics TDR Kit – part number: 6021-5154



E20/20 TDR Accessories

The following is a list of E20/20 TDR replacement an optional accessories available at the time of printing. To see the complete list of accessories, description and pictures visit our web site, position mouse pointer on the tool bar at “Products” and click on “Accessories” in the drop down menu.

www.aeatechnology.com.

Replacement Accessories

<u>Item</u>	<u>Part Number</u>
Belt Case	5001-1002
Soft Carrying Case	6015-1002
AC Adapter	5001-0202
DC Vehicle Adapter	6025-0250
8 AA NiMH Cells	0010-0218
USB Cable, A-to-Mini B	0070-1208
Quick Start Guide	6021-3010
Basic Guide	6021-3020
E20/20 TDR CD	6021-1220
Telco Test Leads	6020-0250 (specific models only)
F Test Lead with Quick Connect	0070-1230 (specific models only)
BNC-to-Alligator Clips	0070-1221 (specific models only)
F-to-Alligator Clips	0070-1220 (specific models only)
N-to-BNC Adapter	0070-1190 (E20/20N model only)

Optional Accessories

<u>Item</u>	<u>Part Number</u>
Hard Carrying Case	6015-1003 (all models except Avionic Kit. See next page)
F Test Lead with Quick Connect	0070-1230
BNC Coax Test Lead	0070-1500
RJ45-RJ45 Test Lead	0070-1219
N-to-SMA Kit	6025-0260
N-to-TNC Adapter	0070-1134
N-to-SO-239 (UHF) Adapter	0070-1195
DC Power Extension Cable	0070-1200
USB Extension Cable	0070-1210
Certificate of Calibration with data	6000-0402 (must be ordered with the TDR or the TDR returned for calibrated)
Certificate of Calibration with before and after data	6000-0403 (TDR must be returned for calibration)

Avionics TDR and Avionics TDR Kit Accessories

The following is a list of Avionics TDR replacement an optional accessories available at the time of printing. To see the complete list of accessories, description and pictures visit our web site, position mouse pointer on the tool bar at “Products” and click on “Accessories” in the drop down menu.
www.aeatechnology.com.

Replacement Accessories

<u>Item</u>	<u>Part Number</u>
Avionics Kit Hard Case	6021-2310 (standard with Avionics Kit only)
Belt Case, Enhanced	6021-0520
Soft Carrying Case	6015-1002 (standard only with Avionics TDR only)
AC Adapter	5001-0202
8 AA NiMH Cells	0010-0218
USB Cable, A-to-Mini B	0070-1208
Quick Start Guide	6021-3010
Basic Guide	6021-3020
E20/20 & Avionics TDR CD	6021-1220
BNC-to-Alligator Clips	0070-1221
BNC Coax Test Lead	0070-1500 (standard with Avionics Kit only)
RJ45-RJ45 Test Lead	0070-1219 (standard with Avionics Kit only)
BNC-to-Pins & Sockets Lead Set	6021-2400 (standard with Avionics Kit only)
Certificate of Calibration with data	6000-0402 (standard with Avionics Kit and Avionics TDR)

Optional Accessories

<u>Item</u>	<u>Part Number</u>
Tyco-Raychem Pins Leads	6021-2410
Tyco-Raychem Socket Leads	6021-2510
F Test Lead with Quick Connect	0070-1230 (requires BNC-to-F adapter, separate source)
DC Power Extension Cable	0070-1200
USB Extension Cable	0070-1210
Certificate of Calibration with before and after data	6000-0403 (TDR must be returned for calibration)

Appendix D

TDR and ETDR PC Vision Resolution Tables

TDR range resolutions				
Range Feet	TDR LCD Resolution		ETDR PC Vision Resolution	
	inches	Feet	inches	Feet
10	0.50		0.06	
20	1.00		0.13	
50	2.50		0.31	
100	5.00		0.63	
200	10.00		1.25	
500		2.08	3.13	
1,000		4.17	6.25	
2,000		8.33		1.04
5,000		20.83		2.60
10,000		41.67		5.21
20,000		83.33		10.42
Range Meters	TDR LCD Resolution		ETDR PC Vision Resolution	
	CM	Meters	CM	Meters
2	0.80		0.10	
5	2.00		0.25	
10	4.00		0.50	
20	8.00		1.00	
50	20.00		2.50	
100	40.00		5.00	
200	80.00		10.00	
500		2.00	25.00	
1000		4.00	50.00	
2000		8.00		1.00
5000		20.00		2.50

- NOTES:
1. When set to "feet" the TDR will create 1920 data points per trace.
 2. When set to "meters" the TDR will create 2000 data points per trace.
 3. Traces are condensed to 240 pixels (feet) or 250 pixels (meters) on the LCD's plot to generate the TDR's LCD resolution.
 4. Saved traces contain the original 1920 or 2000 data points and when uploaded via ETDR PC Vision display in full resolution in the graphs.

Appendix E Cold Weather Operation

Background

Operating the E20/20 TDR or Avionics TDR at colder temperatures will bring some noticeable changes. The LCD screen will slow down and the contrast will require higher than normal contrast settings (11+) to make the screen visible. The batteries may have difficulty maintaining power output until they warm up. NiMH batteries are better in cold weather than alkaline or NiCd cells. Most of these issues can be overcome by using the battery power to warm the unit before going into temperatures near or below freezing. Internal heat sources include the PCB's current flow, batteries discharging, and the LCD.

Procedures

1. If possible, turn on the TDR in a warmer location before entering the cold and allow it to warm up (5-10 minutes) inside its Belt Case.

2. Press  and move the menu cursor to BACKLIGHT. Use the ► key to set on HIGH (increases battery current for more heat).
3. Move the menu cursor to CONTRAST and use the ► key to select 11+. Use the highest setting to keep the text visible. It may need to be raised to 15 (maximum) later in the cold.
4. Move the menu cursor to BATTERY MENU and press the ► key to open the menu. Move the menu cursor to BATTERY SAVER, if not OFF, press ◀ key to turn OFF so the TDR does not auto-power down.

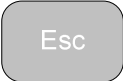
5. Press  twice to exit to the Measurement Screen.
6. While operating in cold temperatures protect the TDR from wind chill as much as practical. When not in use leave the TDR on, close the Belt Case cover, and place inside the Soft Carrying Case or inside a jacket next to the body.
7. Depending on ambient temperature and wind chill, useable time with the Belt Case open may be limited (5-10 minutes) before the LCD slows and fades. Procedures in step 6 above can help recover the display and batteries from the cold.

Operating From Cold Storage

If the TDR has been stored at or below 32°F (0°C), move the TDR to a warmer location, remove it from the Soft Carrying Case and Belt Case for about 30 minutes prior to powering on. Use steps 1 – 4 above to start the TDR before returning to colder temperatures. If possible, use the AC adapter to power the TDR, obtain a display, and speed the warming process before shifting back to battery power. Again, time on battery power is helpful as the cells are heat generators when in use.



5933 Sea Lion Place, Suite 112
Carlsbad, CA 92010
Tel: 1-800-258-7805 or +1-760-931-8979
Fax: +1-760-931-8969
www.aeatechnology.com